

DORMER PRAMET

**FRESAS
INTEGRALES**

2024



DORMER



FRESAS INTEGRALES – CONTENIDO GENERAL

Navegador (por material de la pieza)			P	M	K	N	S	H	
FRESAS INTEGRALES Herramientas para fabricación básica, mantenimiento, reparación, revisión. Utilizadas normalmente con máquinas convencionales. Adecuadas para parámetros de corte bajos.		Ranurado	C1 C3	C1 C3	C1 C3	C366			5
		Desbaste	C9 C4	C908 C948	C9 C4	C9 C4	C908 C948		25
		Semiacabado	C2	C2	C2	C333 C2	C2		35
		Acabado y copiado	C5 C907 C920	C5 C907 C920	C2 C907 C920	C159	C907 C920		45
		Fresas de forma	C8 C7	C8 C7	C8 C7	C8 C7	C8 C7		49
		Fresas de disco y para portafresas	D2 D7 D4	D2 D7 D4	D2 D7 D4	D2 D7 D4	D2 D76 D42		54
		Línea básica de metal duro	S9		S9	S9			69
Herramientas de metal duro para fabricación mixta. Adecuadas para parámetros de corte moderados.		Ranurado	S8	S71.	S8	S8	S71.		79
		Semiacabado	S8	S71.	S8	S8	S71.		95
Herramientas de metal duro para procesos seguros y productividad. Utilizadas normalmente con CNC y fabricación automatizada. Adecuadas para parámetros de corte elevados.		Achaflanado	S739 S740	S739 S740	S739 S740		S739 S740		105
		Desbaste y HFC	S765	S765	S765	S6..	S765	S536 (HFC)	109
		Fresado trocoidal	S77.	S77.	S77.		S77.	S52.	121
		Semiacabado	S76.	S26.	S76.	S662 S612	S76.	S5	126
		Acabado	S768	S2	S768		S2	S5	145
		Fresado en copia	S791	S2 S791	S511	S629	S2	S5	153
		Fresado de roscas	Formas de rosca: M, MF, UNC, UNF, G, NPT						
LIMAS ROTATIVAS		(por idoneidad)	P ST	M VA	PMKSH DC	N AL GRP	S AS	Sets P100 P101	180

INSTRUCCIONES	¿Cómo leer los datos del catálogo? (ISO 13399, iconos, navegación...)								250	
	Descripción general de Materiales y Recubrimientos								256	
	Fresas HSS + HM – Información técnica								257	
	HSS	Tablas de avance, correcciones				261	HM	Tablas de avance, correcciones		266
	Fresas de roscar – Consejos				271	Tablas de avance			272	
	Limas Rotativas – Consejos				275	Velocidades			277	
	Grupos de materiales de pieza (WMG)								278	



HERRAMIENTAS ROTATIVAS INTEGRALES – ÍNDICE (ALFABÉTICO)

FAMILIA DE PRODUCTOS		FAMILIA DE PRODUCTOS		FAMILIA DE PRODUCTOS		FAMILIA DE PRODUCTOS	
C		P		S		S804HA	96
C110	6	P100	246	S219	137	S804HB	97
C122	16	P101	247	S225	146	S812HA	82
C123	11	P501	234	S226	147	S812HB	83
C126	8	P505	235	S227	148	S813HA	88
C135	15	P507	236	S229	156	S813HB	89
C139	13	P509	237	S231	157	S814HA	98
C159	10	P511	238	S233	158	S814HB	99
C167	14	P513	239	S260	134	S822	85
C246	40	P515	240	S262	135	S823	91
C247	38	P521	241	S501	154	S902	70
C273	41	P523	242	S511	155	S903	72
C295	43	P601	214	S521	140	S904	74
C299	36	P605	215	S523	141	S922	71
C305	21	P607	216	S524	143	S933	73
C306	17	P609	217	S525	149	S944	75
C346	24	P611	218	S526	150	S991	76
C352	23	P613	219	S527	151		
C353	18	P615	220	S529	160		
C367	20	P621	221	S531	161		
C400	27	P701	204	S533	162		
C407	29	P703	205	S534	163		
C413	28	P705	206	S535	164		
C428	30	P707	207	S536	119		
C492	32	P709	208	S561	144		
C500	47	P711	209	S610	113		
C505	48	P713	210	S611	114		
C700	50	P715	211	S612	138		
C800	52	P721	212	S614	118		
C822	53	P801	182	S629	159		
C830	51	P801C	183	S637	112		
C907	37	P803	184	S638	115		
C908	31	P803C	185	S650	116		
C920	46	P805	186	S654	117		
C922	26	P805C	187	S662	139		
C948	33	P807	188	S710	84		
D		P807C	189	S713	90		
D400	65	P809	190	S714	92		
D402	67	P811	191	S715	93		
D420	66	P811C	192	S716	100		
D745	56	P813	193	S717	101		
D747	58	P813C	194	S718	102		
D750	60	P815	195	S722HB	132		
D751	61	P815C	196	S739	106		
D752	62	P817	197	S740	107		
D753	63	P819	198	S761	128		
D763	64	P821	199	S763	129		
J		P821C	200	S765	110		
J200	168	P823	201	S765HB	111		
J205	169	P825	202	S766	130		
J210	170	P831	224	S767	131		
J215	171	P833	225	S768	133		
J220	172	P835	226	S770HB	122		
J225	173	P837	227	S771HB	123		
J235	174	P841	228	S772HB	124		
J245	175	P842	229	S773HB	125		
J260	176	P843	230	S791	165		
J280	177	P844	231	S802HA	80		
M		P880	244	S802HB	81		
M902	248	P890	245	S803HA	86		
				S803HB	87		



**HERRAMIENTAS PARA FABRICACIÓN BÁSICA, MANTENIMIENTO, REPARACIÓN, REVISIÓN.
UTILIZADAS NORMALMENTE CON MÁQUINAS CONVENCIONALES.**

Código de Material (BMC)	HSS-E PM	HSS-E PM	HSS-E	HSS-E PM	HSS-E PM	HSS-E	HSS-E	HSS-E	HSS-E PM	HSS-E PM	HSS-E PM	HSS-E PM	HSS-E	
Perfil de la fresa	N	N	W	N	N	N	N	N	N	N	N	N	N	
Número de canales (NOF)	NOF 2	NOF 2	NOF 2	NOF 2	NOF 2	NOF 2	NOF 2	NOF 2	NOF 3	NOF 3	NOF 3	NOF 3	NOF 3	
Longitud de corte														
Ángulo de hélice (FHA)	λ 30°	λ 30°	λ 40°	λ 30°	λ 30°	λ 30°	λ 30°	λ 30°	λ 30°	λ 30°	λ 40°	λ 30°	λ 30°	
Ángulo de hélice (FHA)	λ 30°	λ 30°	λ 40°	λ 30°	λ 30°	λ 30°	λ 30°	λ 30°	λ 30°	λ 30°	λ 40°	λ 30°	λ 30°	
Ángulo de incidencia radial (GAMF)	γ 12°	γ 12°	γ 20°	γ 12°	γ 12°	γ 12°	γ 12°	γ 12°	γ 12°	γ 12°	γ 15°	γ 12°	γ 12°	
Mango														
Recubrimiento	Bright	TiCN	Bright	Bright	TiCN	Bright	Bright	Bright	Bright	Bright	Alcrona	Alcrona	Bright	
Clase de tolerancia del diámetro de corte (TCDC)	DC e8	DC e8	DC e8	DC e8	DC e8	DC js14	DC e8	DC e8	DC e8	DC e8	DC e8	DC e8	DC e8	
Dirección														
Grupo básico estándar (BSG)	DIN 327D	DIN 327D	DIN 844K	DIN 844K	DIN 844K	DORMER	DORMER	DORMER	DIN 327D	DIN 327D	DIN 327D	DIN 844K	DIN 844L	
Código de Familia de Producto	C110	C126	C159	C123	C139	C167	C135	C122	C306	C353	C367	C305	C352	C346
Gama de diámetros de corte PSF	1.00 – 40.00	1.00 – 25.00	2.00 – 20.00	1/16 – 30.00	2.00 – 22.00	6.00 – 16.00	2.00 – 20.00	5.00 – 22.00	3.00 – 30.00	3.00 – 30.00	2.00 – 20.00	2.00 – 32.00	3.00 – 20.00	3.00 – 20.00
P	P1	■	■	■	■	■	■	■	■	■	■	■	■	■
	P2	■	■	■	■	■	■	■	■	■	■	■	■	■
	P3	■	■	■	■	■	■	■	■	■	■	■	■	■
	P4	■	■	■	■	■	■	■	■	■	■	■	■	■
M	M1	■	■	■	■	■	■	■	■	■	■	■	■	■
	M2	■	■	■	■	■	■	■	■	■	■	■	■	■
	M3	■	■	■	■	■	■	■	■	■	■	■	■	■
	M4	■	■	■	■	■	■	■	■	■	■	■	■	■
K	K1	■	■	■	■	■	■	■	■	■	■	■	■	■
	K2	■	■	■	■	■	■	■	■	■	■	■	■	■
	K3	■	■	■	■	■	■	■	■	■	■	■	■	■
	K4	■	■	■	■	■	■	■	■	■	■	■	■	■
	K5	■	■	■	■	■	■	■	■	■	■	■	■	■
N	N1	■	■	■	■	■	■	■	■	■	■	■	■	■
	N2	■	■	■	■	■	■	■	■	■	■	■	■	■
	N3	■	■	■	■	■	■	■	■	■	■	■	■	■
	N4	■	■	■	■	■	■	■	■	■	■	■	■	■
	N5	■	■	■	■	■	■	■	■	■	■	■	■	■
S	S1	■	■	■	■	■	■	■	■	■	■	■	■	■
	S2	■	■	■	■	■	■	■	■	■	■	■	■	■
	S3	■	■	■	■	■	■	■	■	■	■	■	■	■
	S4	■	■	■	■	■	■	■	■	■	■	■	■	■
H	H1													
	H2													
	H3													
	H4													

C110



Fresa HSS-E-PM de 2 Filos para Ranurado, Acabado Brillante

Fresa con longitud de corte extra corta de 2 filos que proporciona alta rigidez. Adecuada para fresado de ranuras poco profundas con tolerancia P9 y operaciones de fresado en rampa. Su precisión la hace indicada para el fresado de chaveteros estándar con tolerancia P9. Adecuada para aceros blandos, materiales no féreos y aleaciones de titanio de resistencia media.

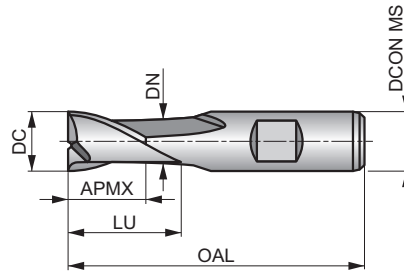

HSS-E PM	N	NOF 2
	λ 30°	γ 12°
DIN 1835B	Bright	DC e8
	DIN 327D	



Grupo de Material de la pieza adecuado. Valores de inicio de la velocidad de corte (m/min) y código alfabético. Las tablas con avances por diente y factores de corrección en la pag. 261.

P1.1 ■ 53 E	P1.2 ■ 59 E	P1.3 ■ 61 E	P2.1 ■ 45 E	P2.2 ■ 40 E	P3.1 ■ 37 E	P3.2 ■ 30 D	P4.1 ■ 22 D	M1.1 ■ 41 E	M1.2 ■ 35 E	M2.1 ■ 37 E	M2.2 ■ 30 D	K1.1 ■ 35 E	K1.2 ■ 26 E
K1.3 ■ 19 E	K2.1 ■ 62 E	K2.2 ■ 50 E	K2.3 ■ 40 D	K3.1 ■ 54 E	K3.2 ■ 42 E	K3.3 ■ 34 D	K4.1 ■ 50 D	K4.2 ■ 38 D	K4.3 ■ 28 D	K4.4 ■ 24 C	K4.5 ■ 20 C	K5.1 ■ 57 D	K5.2 ■ 43 D
K5.3 ■ 33 D	N1.1 ■ 95 G	N1.2 ■ 71 F	N1.3 ■ 48 F	N2.1 ■ 48 E	N2.2 ■ 43 E	N2.3 ■ 31 E	N3.1 ■ 50 E	N3.2 ■ 29 E	N3.3 ■ 15 E	N4.1 ■ 50 E	S1.1 ■ 35 D	S1.2 ■ 25 D	S2.1 ■ 20 C
S3.1 ■ 15 C	S4.1 ■ 12 C												

DCON MS tolerancia h6.

Product	DC (inch)	DC (mm)	DCON MS (mm)	APMX (mm)	OAL (mm)	NOF	LU (mm)	DN (mm)
C1101.0	–	1.00	6.00	2.50	47.0	2	–	–
C1101.5	–	1.50	6.00	3.00	47.0	2	–	–
C1101/16	1/16	1.59	6.00	3.00	47.0	2	–	–
C1101.8	–	1.80	6.00	4.00	48.0	2	–	–
C1102.0	–	2.00	6.00	4.00	48.0	2	–	–
C1103/32	3/32	2.38	6.00	5.00	49.0	2	–	–
C1102.5	–	2.50	6.00	5.00	49.0	2	–	–
C1102.8	–	2.80	6.00	5.00	49.0	2	–	–
C1103.0	–	3.00	6.00	5.00	49.0	2	–	–
C1101/8	1/8	3.18	6.00	6.00	50.0	2	–	–
C1103.5	–	3.50	6.00	6.00	50.0	2	–	–
C1103.8	–	3.80	6.00	7.00	51.0	2	–	–
C1104.0	–	4.00	6.00	7.00	51.0	2	–	–
C1104.5	–	4.50	6.00	7.00	51.0	2	–	–
C1103/16	3/16	4.76	6.00	8.00	52.0	2	–	–
C1105.0	–	5.00	6.00	8.00	52.0	2	–	–
C1105.5	–	5.50	6.00	8.00	52.0	2	–	–
C1105.75 ²⁾	–	5.75	6.00	8.00	52.0	2	–	–
C1106.0	–	6.00	6.00	8.00	52.0	2	–	–
C1101/4	1/4	6.35	10.00	10.00	60.0	2	–	–
C1106.5	–	6.50	10.00	10.00	60.0	2	–	–
C1107.0	–	7.00	10.00	10.00	60.0	2	–	–
C1107.5	–	7.50	10.00	10.00	60.0	2	–	–
C1107.75 ²⁾	–	7.75	10.00	11.00	61.0	2	–	–
C1105/16	5/16	7.94	10.00	11.00	61.0	2	–	–



Product	DC	DC	DCON MS	APMX	OAL	NOF	LU	DN
	(inch)	(mm)	(mm)	(mm)	(mm)		(mm)	(mm)
C1108.0	–	8.00	10.00	11.00	61.0	2	–	–
C1108.5	–	8.50	10.00	11.00	61.0	2	–	–
C1109.0	–	9.00	10.00	11.00	61.0	2	–	–
C1109.5	–	9.50	10.00	11.00	61.0	2	–	–
C1103/8	3/8	9.52	10.00	13.00	63.0	2	22.50	9.50
C11010.0	–	10.00	10.00	13.00	63.0	2	22.50	9.50
C11013/32	13/32	10.32	12.00	13.00	70.0	2	–	–
C11010.5	–	10.50	12.00	13.00	70.0	2	–	–
C11011.0	–	11.00	12.00	13.00	70.0	2	–	–
C1107/16	7/16	11.11	12.00	13.00	70.0	2	–	–
C11011.5	–	11.50	12.00	13.00	70.0	2	–	–
C11012.0	–	12.00	12.00	16.00	73.0	2	27.50	11.50
C11012.5	–	12.50	12.00	16.00	73.0	2	27.50	11.50
C1101/2	1/2	12.70	12.00	16.00	73.0	2	27.50	11.50
C11013.0	–	13.00	12.00	16.00	73.0	2	27.50	11.50
C11017/32	17/32	13.49	12.00	16.00	73.0	2	27.50	11.50
C11014.0	–	14.00	12.00	16.00	73.0	2	27.50	11.50
C1109/16	9/16	14.29	12.00	16.00	73.0	2	27.50	11.50
C11015.0	–	15.00	12.00	16.00	73.0	2	27.50	11.50
C1105/8	5/8	15.88	16.00	19.00	79.0	2	30.50	15.50
C11016.0	–	16.00	16.00	19.00	79.0	2	30.50	15.50
C11017.0	–	17.00	16.00	19.00	79.0	2	30.50	15.50
C11011/16	11/16	17.46	16.00	19.00	79.0	2	30.50	15.50
C11018.0	–	18.00	16.00	19.00	79.0	2	30.50	15.50
C11019.0	–	19.00	16.00	19.00	79.0	2	30.50	15.50
C1103/4	3/4	19.05	20.00	22.00	88.0	2	37.50	18.50
C11020.0	–	20.00	20.00	22.00	88.0	2	37.50	19.50
C11022.0	–	22.00	20.00	22.00	88.0	2	37.50	19.50
C1107/8	7/8	22.22	20.00	22.00	88.0	2	37.50	19.50
C11024.0	–	24.00	25.00	26.00	102.0	2	45.50	23.50
C11025.0	–	25.00	25.00	26.00	102.0	2	45.50	24.50
C1101	1"	25.40	25.00	26.00	102.0	2	45.50	24.50
C11026.0	–	26.00	25.00	26.00	102.0	2	45.50	24.50
C11028.0	–	28.00	25.00	26.00	102.0	2	45.50	24.50
C11030.0	–	30.00	25.00	26.00	102.0	2	45.50	24.50
C11032.0	–	32.00	32.00	32.00	112.0	2	51.50	31.50
C11035.0¹⁾	–	35.00	32.00	32.00	112.0	2	51.50	31.50
C11036.0¹⁾	–	36.00	32.00	32.00	112.0	2	51.50	31.50
C11040.0¹⁾	–	40.00	40.00	38.00	130.0	2	59.50	39.00

¹⁾ DC tolerancia h10; Disponible solo en HSS-E.²⁾ DC tolerancia h10; no ranura en tolerancia P9

C126



Fresa HSS-E-PM de 2 Filos para Ranurado, Recubrimiento TiCN

Fresa con longitud de corte extra corta de 2 filos que proporciona alta rigidez. Adecuada para fresado de ranuras poco profundas con tolerancia P9 y operaciones de fresado en rampa. Su precisión la hace indicada para el fresado de chaveteros estándar con tolerancia P9. El recubrimiento TiCN incrementa la vida útil y mejora el rendimiento en materiales duros y abrasivos.

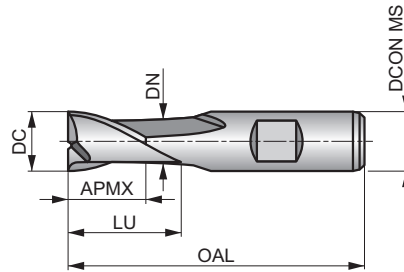

HSS-E PM	N	NOF 2
	λ 30°	γ 12°
	TiCN	DC e8
	DIN 327D	



Grupo de Material de la pieza adecuado. Valores de inicio de la velocidad de corte (m/min) y código alfabético. Las tablas con avances por diente y factores de corrección en la pag. 261.

P1.1 ■ 126 E	P1.2 ■ 141 E	P1.3 ■ 146 E	P2.1 ■ 108 E	P2.2 ■ 95 E	P2.3 ▣ 84 D	P3.1 ■ 81 E	P3.2 ■ 65 D	P3.3 ▣ 55 D	P4.1 ■ 48 D	P4.2 ▣ 41 D	P4.3 ▣ 34 D	M1.1 ▣ 62 E	M1.2 ▣ 52 E
M2.1 ▣ 55 E	M2.2 ▣ 45 D	M3.3 ▣ 26 C	M4.1 ▣ 25 C	K1.1 ■ 60 E	K1.2 ■ 44 E	K1.3 ■ 33 E	K2.1 ■ 111 E	K2.2 ■ 90 E	K2.3 ■ 72 D	K3.1 ■ 98 E	K3.2 ■ 75 E	K3.3 ■ 61 D	K4.1 ■ 91 D
K4.2 ■ 68 D	K4.3 ■ 50 D	K4.4 ■ 43 C	K4.5 ■ 36 C	K5.1 ■ 103 D	K5.2 ■ 77 D	K5.3 ■ 60 D	N1.1 ▣ 177 G	N1.2 ▣ 133 F	N1.3 ▣ 89 F	N2.1 ▣ 89 E	N2.2 ■ 80 E	N2.3 ■ 57 E	N3.1 ■ 93 E
N3.2 ■ 55 E	N3.3 ■ 28 E	N4.1 ▣ 93 E	S1.1 ■ 45 D	S1.2 ■ 40 D	S1.3 ▣ 15 C	S2.1 ■ 33 C	S2.2 ▣ 14 C	S3.1 ■ 25 C	S3.2 ▣ 10 C	S4.1 ■ 20 C	S4.2 ▣ 8 C		

DCON MS tolerancia h6.

Product	DC (mm)	DCON MS (mm)	APMX (mm)	OAL (mm)	NOF	LU (mm)	DN (mm)
C1261.0	1.00	6.00	2.50	47.0	2	-	-
C1261.5	1.50	6.00	3.00	47.0	2	-	-
C1262.0	2.00	6.00	4.00	48.0	2	-	-
C1262.5	2.50	6.00	5.00	49.0	2	-	-
C1263.0	3.00	6.00	5.00	49.0	2	-	-
C1263.5	3.50	6.00	6.00	50.0	2	-	-
C1264.0	4.00	6.00	7.00	51.0	2	-	-
C1264.5	4.50	6.00	7.00	51.0	2	-	-
C1265.0	5.00	6.00	8.00	52.0	2	-	-
C1265.5	5.50	6.00	8.00	52.0	2	-	-
C1266.0	6.00	6.00	8.00	52.0	2	-	-
C1266.5	6.50	10.00	10.00	60.0	2	-	-
C1267.0	7.00	10.00	10.00	60.0	2	-	-
C1267.5	7.50	10.00	10.00	60.0	2	-	-
C1268.0	8.00	10.00	11.00	61.0	2	-	-
C1268.5	8.50	10.00	11.00	61.0	2	-	-
C1269.0	9.00	10.00	11.00	61.0	2	-	-
C12610.0	10.00	10.00	13.00	63.0	2	22.50	9.50
C12610.5	10.50	12.00	13.00	70.0	2	-	-
C12611.0	11.00	12.00	13.00	70.0	2	-	-
C12611.5	11.50	12.00	13.00	70.0	2	-	-
C12612.0	12.00	12.00	16.00	73.0	2	27.50	11.50
C12612.5	12.50	12.00	16.00	73.0	2	27.50	11.50
C12613.0	13.00	12.00	16.00	73.0	2	27.50	11.50
C12614.0	14.00	12.00	16.00	73.0	2	27.50	11.50



Product	DC	DCON MS	APMX	OAL	NOF	LU	DN
	(mm)	(mm)	(mm)	(mm)		(mm)	(mm)
C12615.0	15.00	12.00	16.00	73.0	2	27.50	11.50
C12616.0	16.00	16.00	19.00	79.0	2	30.50	15.50
C12618.0	18.00	16.00	19.00	79.0	2	30.50	15.50
C12620.0	20.00	20.00	22.00	88.0	2	37.50	19.50
C12622.0	22.00	20.00	22.00	88.0	2	37.50	19.50
C12624.0	24.00	25.00	26.00	102.0	2	45.50	23.50
C12625.0	25.00	25.00	26.00	102.0	2	45.50	24.50

C159



Fresa HSS-E de 2 Filos para Ranurado, Acabado Brillante

Fresa con longitud de corte corta de 2 filos con hélice de 40° para fresado de ranuras, perfilado y fresado en rampa en materiales blandos. Su precisión la hace indicada para el fresado de chaveteros estándar con tolerancia P9. Diseñada específicamente para mecanizar materiales no féreos.

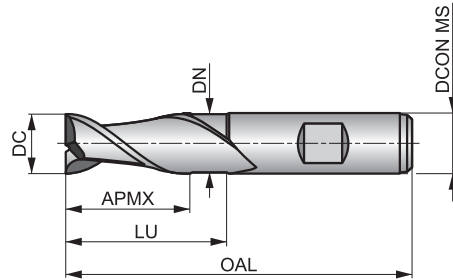

HSS-E	W	NOF 2
	λ 40°	γ 20°
DIN 1835B	Bright	DC e8
	DIN 844K	



Grupo de Material de la pieza adecuado. Valores de inicio de la velocidad de corte (m/min) y código alfabético. Las tablas con avances por diente y factores de corrección en la pag. 261.

P1.1 ■ 46 D	P1.2 ■ 52 D	P1.3 ■ 54 D	P2.1 ■ 40 D	P2.2 ■ 35 D	M1.1 ■ 32 D	M1.2 ■ 27 D	M2.1 ■ 28 D	M2.2 ■ 23 C	M3.1 ■ 22 C	M3.2 ■ 19 C	N1.1 ■ 142 F	N1.2 ■ 107 E	N1.3 ■ 72 E
N2.1 ■ 72 D	N2.2 ■ 64 D	N2.3 ■ 46 D	N3.1 ■ 75 D	N3.2 ■ 44 D	N3.3 ■ 22 D	N4.1 ■ 75 D	N4.2 ■ 29 D	S1.1 ■ 28 C					

DCON MS tolerancia h6.

Product	DC (mm)	DCON MS (mm)	APMX (mm)	OAL (mm)	NOF	LU (mm)	DN (mm)
C1592.0	2.00	6.00	7.00	51.0	2	—	—
C1593.0	3.00	6.00	8.00	52.0	2	—	—
C1594.0	4.00	6.00	11.00	55.0	2	—	—
C1595.0	5.00	6.00	13.00	57.0	2	—	—
C1596.0	6.00	6.00	13.00	57.0	2	—	—
C1598.0	8.00	10.00	19.00	69.0	2	—	—
C15910.0	10.00	10.00	22.00	72.0	2	—	—
C15912.0	12.00	12.00	26.00	83.0	2	—	—
C15914.0	14.00	12.00	26.00	83.0	2	37.50	11.50
C15916.0	16.00	16.00	32.00	92.0	2	43.50	15.50
C15918.0	18.00	16.00	32.00	92.0	2	43.50	15.50
C15920.0	20.00	20.00	38.00	104.0	2	53.50	19.50

C123



Fresa HSS-E-PM de 2 Filos para Ranurado, Acabado Brillante

Fresa con longitud de corte corta de 2 filos que proporciona alta rigidez y es adecuada para fresado de ranuras poco profundas y fresado en rampa. Su precisión la hace indicada para el fresado de chaveteros estándar con tolerancia P9. Versátil, se puede utilizar en aceros blandos, materiales no férreos y aleaciones de titanio de resistencia media.

HSS-E PM	N	NOF 2
	λ 30°	γ 12°
DIN 1835B	Bright	DC e8
	DIN 844K	

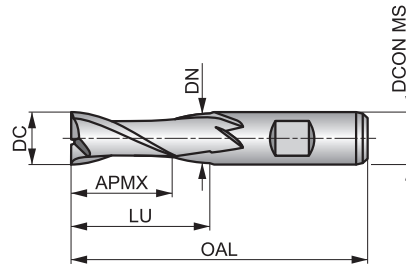

Grupo de Material de la pieza adecuado. Valores de inicio de la velocidad de corte (m/min) y código alfabético. Las tablas con avances por diente y factores de corrección en la pag. 261.

P1.1 ■ 53 D	P1.2 ■ 59 D	P1.3 ■ 61 D	P2.1 ■ 45 D	P2.2 ■ 40 D	P3.1 ■ 37 D	P3.2 ■ 30 C	P4.1 ■ 22 C	M1.1 ■ 34 D	M1.2 ■ 29 D	M2.1 ■ 31 D	M2.2 ■ 25 C	K1.1 ■ 30 D	K1.2 ■ 22 D
K1.3 ■ 17 D	K2.1 ■ 55 D	K2.2 ■ 45 D	K2.3 ■ 36 C	K3.1 ■ 49 D	K3.2 ■ 37 D	K3.3 ■ 30 B	K4.1 ■ 45 C	K4.2 ■ 34 C	K4.3 ■ 25 C	K4.4 ■ 22 B	K4.5 ■ 18 B	K5.1 ■ 51 C	K5.2 ■ 39 C
K5.3 ■ 30 C	N1.1 ■ 95 F	N1.2 ■ 71 E	N1.3 ■ 48 E	N2.1 ■ 48 D	N2.2 ■ 43 D	N2.3 ■ 31 D	N3.1 ■ 50 D	N3.2 ■ 29 D	N3.3 ■ 15 D	N4.1 ■ 50 D	S1.1 ■ 30 C	S1.2 ■ 25 C	S2.1 ■ 20 B
S3.1 ■ 15 B	S4.1 ■ 12 B												

DCON MS tolerancia h6.

Product	DC	DC	DCON MS	APMX	OAL	NOF	LU	DN
	(inch)	(mm)						
C1231/16 ¹⁾	1/16	1.59	6.00	7.00	51.0	2	-	-
C1232.0	-	2.00	6.00	7.00	51.0	2	-	-
C1232.5	-	2.50	6.00	8.00	52.0	2	-	-
C1233.0	-	3.00	6.00	8.00	52.0	2	-	-
C1231/8 ¹⁾	1/8	3.18	6.00	10.00	54.0	2	-	-
C1233.5	-	3.50	6.00	10.00	54.0	2	-	-
C1235/32 ¹⁾	5/32	3.97	6.00	11.00	55.0	2	-	-
C1234.0	-	4.00	6.00	11.00	55.0	2	-	-
C1234.5	-	4.50	6.00	11.00	55.0	2	-	-
C1233/16 ¹⁾	3/16	4.76	6.00	13.00	57.0	2	-	-
C1235.0	-	5.00	6.00	13.00	57.0	2	-	-
C1235.5	-	5.50	6.00	13.00	57.0	2	-	-
C1236.0	-	6.00	6.00	13.00	57.0	2	-	-
C1231/4 ¹⁾	1/4	6.35	10.00	16.00	66.0	2	-	-
C1236.5	-	6.50	10.00	16.00	66.0	2	-	-
C1237.0	-	7.00	10.00	16.00	66.0	2	-	-
C1237.5	-	7.50	10.00	16.00	66.0	2	-	-
C1235/16 ¹⁾	5/16	7.94	10.00	19.00	69.0	2	-	-
C1238.0	-	8.00	10.00	19.00	69.0	2	-	-
C1238.5	-	8.50	10.00	19.00	69.0	2	-	-
C1239.0	-	9.00	10.00	19.00	69.0	2	-	-
C1239.5	-	9.50	10.00	19.00	69.0	2	-	-
C1233/8 ¹⁾	3/8	9.52	10.00	22.00	72.0	2	31.50	9.50
C12310.0	-	10.00	10.00	22.00	72.0	2	31.50	9.50
C12311.0	-	11.00	12.00	22.00	79.0	2	-	-

Product	DC	DC	D CON MS	APMX	OAL	NOF	LU	DN
	(inch)	(mm)	(mm)	(mm)	(mm)		(mm)	(mm)
C12312.0	–	12.00	12.00	26.00	83.0	2	37.50	11.50
C12312.0 ¹⁾	1/2	12.70	12.00	26.00	83.0	2	37.50	11.50
C12313.0	–	13.00	12.00	26.00	83.0	2	37.50	11.50
C12314.0	–	14.00	12.00	26.00	83.0	2	37.50	11.50
C12315.0	–	15.00	12.00	26.00	83.0	2	37.50	11.50
C12316.0	–	16.00	16.00	32.00	92.0	2	43.50	15.50
C12318.0	–	18.00	16.00	32.00	92.0	2	43.50	15.50
C12320.0	–	20.00	20.00	38.00	104.0	2	53.50	19.50
C12322.0	–	22.00	20.00	38.00	104.0	2	53.50	19.50
C12325.0	–	25.00	25.00	45.00	121.0	2	64.50	24.50
C12330.0	–	30.00	25.00	45.00	121.0	2	64.50	24.50

¹⁾ DC tolerancias -0.0005 pulgadas / -0.0013 pulgadas

C139



Fresa HSS-E-PM de 2 Filos para Ranurado, Recubrimiento TiCN

Fresa con longitud de corte corta de 2 filos que proporciona alta rigidez. Adecuada para fresado de ranuras poco profundas y operaciones de fresado en rampa. Su precisión la hace indicada para el fresado de chaveteros estándar con tolerancia P9. El recubrimiento TiCN incrementa la vida útil y mejora el rendimiento en materiales duros y abrasivos.

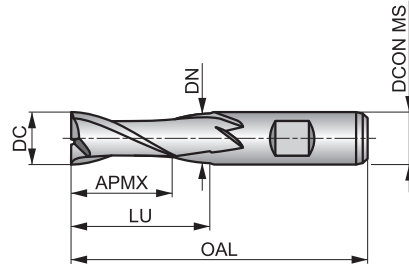

HSS-E PM	N	NOF 2
	λ 30°	γ 12°
	TiCN	DC e8
	DIN 844K	



Grupo de Material de la pieza adecuado. Valores de inicio de la velocidad de corte (m/min) y código alfabético. Las tablas con avances por diente y factores de corrección en la pag. 261.

P1.1 ■ 113 D	P1.2 ■ 126 D	P1.3 ■ 131 D	P2.1 ■ 97 D	P2.2 ■ 85 D	P2.3 ▣ 75 C	P3.1 ■ 74 D	P3.2 ■ 59 C	P3.3 ▣ 50 C	P4.1 ■ 44 C	P4.2 ▣ 37 C	P4.3 ▣ 31 C	M1.1 ▣ 62 D	M1.2 ▣ 52 D
M2.1 ▣ 55 D	M2.2 ▣ 45 C	M3.3 ▣ 26 B	M4.1 ▣ 25 B	K1.1 ■ 55 D	K1.2 ■ 41 D	K1.3 ■ 31 D	K2.1 ■ 98 D	K2.2 ■ 80 D	K2.3 ■ 64 C	K3.1 ■ 87 D	K3.2 ■ 67 D	K3.3 ■ 54 B	K4.1 ■ 81 C
K4.2 ■ 61 C	K4.3 ■ 45 C	K4.4 ■ 38 B	K4.5 ■ 32 B	K5.1 ■ 91 C	K5.2 ■ 69 C	K5.3 ■ 53 C	N1.1 ▣ 159 F	N1.2 ▣ 120 E	N1.3 ▣ 80 E	N2.1 ▣ 80 D	N2.2 ▣ 72 D	N2.3 ■ 51 D	N3.1 ■ 84 D
N3.2 ■ 50 D	N3.3 ■ 25 D	N4.1 ▣ 84 D	S1.1 ■ 45 C	S1.2 ■ 35 C	S1.3 ▣ 15 B	S2.1 ■ 33 B	S2.2 ▣ 14 B	S3.1 ■ 25 B	S3.2 ▣ 10 B	S4.1 ■ 20 B	S4.2 ▣ 8 B		

DCON MS tolerancia h6.

Product	DC (mm)	DCON MS (mm)	APMX (mm)	OAL (mm)	NOF	LU (mm)	DN (mm)
C1392.0	2.00	6.00	7.00	51.0	2	-	-
C1393.0	3.00	6.00	8.00	52.0	2	-	-
C1394.0	4.00	6.00	11.00	55.0	2	-	-
C1395.0	5.00	6.00	13.00	57.0	2	-	-
C1395.5	5.50	6.00	13.00	57.0	2	-	-
C1396.0	6.00	6.00	13.00	57.0	2	-	-
C1396.5	6.50	10.00	16.00	66.0	2	-	-
C1397.0	7.00	10.00	16.00	66.0	2	-	-
C1397.5	7.50	10.00	16.00	66.0	2	-	-
C1398.0	8.00	10.00	19.00	69.0	2	-	-
C1398.5	8.50	10.00	19.00	69.0	2	-	-
C1399.0	9.00	10.00	19.00	69.0	2	-	-
C13910.0	10.00	10.00	22.00	72.0	2	31.50	9.50
C13911.0	11.00	12.00	22.00	79.0	2	-	-
C13912.0	12.00	12.00	26.00	83.0	2	37.50	11.50
C13913.0	13.00	12.00	26.00	83.0	2	37.50	11.50
C13914.0	14.00	12.00	26.00	83.0	2	37.50	11.50
C13915.0	15.00	12.00	26.00	83.0	2	37.50	11.50
C13916.0	16.00	16.00	32.00	92.0	2	43.50	15.50
C13918.0	18.00	16.00	32.00	92.0	2	43.50	15.50
C13920.0	20.00	20.00	38.00	104.0	2	53.50	19.50
C13922.0	22.00	20.00	38.00	104.0	2	53.50	19.50

C167

DORMER



Fresa HSS-E de 2 Filos con Alcance Extra Largo, Acabado Brillante

Fresa con longitud de corte corta de 2 filos, sin cuello reducido y alcance extra largo para poder mecanizar en cajas muy profundas en zonas de difícil acceso. Adecuada para fresado de aceros suaves y materiales no férreos.

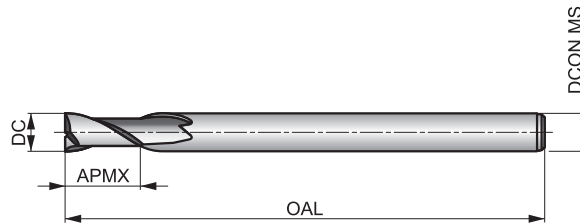

HSS-E	N	NOF 2
	λ 30°	γ 12°
DIN 1835A	Bright	DC js14
	DORMER	



Grupo de Material de la pieza adecuado. Valores de inicio de la velocidad de corte (m/min) y código alfabético. Las tablas con avances por diente y factores de corrección en la pag. 261.

P1.1 ■ 46 C	P1.2 ■ 52 C	P1.3 ■ 54 C	P2.1 ■ 40 C	P2.2 ■ 35 C	P3.1 ■ 32 C	P3.2 ■ 26 B	P4.1 ■ 19 B	M1.1 ■ 34 C	M1.2 ■ 29 C	M2.1 ■ 31 C	M2.2 ■ 25 B	K1.1 ■ 30 C	K1.2 ■ 22 C
K1.3 ■ 17 C	K2.1 ■ 49 C	K2.2 ■ 40 C	K2.3 ■ 32 B	K3.1 ■ 44 C	K3.2 ■ 33 C	K3.3 ■ 27 A	K4.1 ■ 40 B	K4.2 ■ 30 B	K4.3 ■ 22 B	K4.4 ■ 19 A	K4.5 ■ 16 A	K5.1 ■ 46 B	K5.2 ■ 34 B
K5.3 ■ 27 B	N1.1 ■ 81 E	N1.2 ■ 60 D	N1.3 ■ 41 D	N2.1 ■ 41 C	N2.2 ■ 37 C	N2.3 ■ 26 C	N3.1 ■ 43 C	N3.2 ■ 25 C	N3.3 ■ 13 C	N4.1 ■ 43 C	S1.1 ■ 30 B	S1.2 ■ 25 B	S2.1 ■ 20 A
S3.1 ■ 15 A	S4.1 ■ 12 A												

DCON MS tolerancia h6.

Product	DC (mm)	DCON MS (mm)	APMX (mm)	OAL (mm)	NOF
C1676.0	6.00	6.00	13.00	180.0	2
C1678.0	8.00	8.00	19.00	180.0	2
C16710.0	10.00	10.00	22.00	200.0	2
C16712.0	12.00	12.00	26.00	200.0	2
C16716.0	16.00	16.00	32.00	200.0	2

C135



Fresa HSS-E de 2 Filos para Ranurado con Alcance Extra Largo, Acabado Brillante

Fresa con longitud de corte corta de 2 filos que proporciona alta rigidez para fresado de chaveteros estándar con tolerancia P9. Proporciona mayor resistencia y reduce vibraciones en áreas de difícil acceso. Adecuada para aceros blandos y materiales no ferreos.

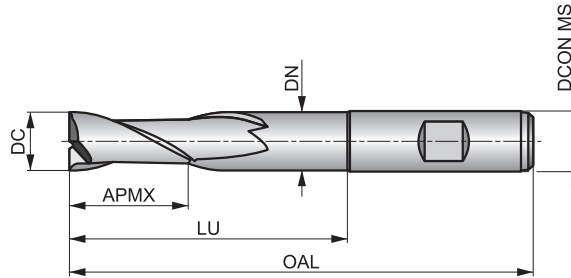

HSS-E	N	NOF 2
	λ 30°	γ 12°
DIN 1835B	Bright	DC e8



Grupo de Material de la pieza adecuado. Valores de inicio de la velocidad de corte (m/min) y código alfabético. Las tablas con avances por diente y factores de corrección en la pag. 261.

P1.1 ■ 46 C	P1.2 ■ 52 C	P1.3 ■ 54 C	P2.1 ■ 40 C	P2.2 ■ 35 C	P3.1 ■ 32 C	P3.2 ■ 26 B	P4.1 ■ 19 B	M1.1 ■ 34 C	M1.2 ■ 29 C	M2.1 ■ 31 C	M2.2 ■ 25 B	K1.1 ■ 30 C	K1.2 ■ 22 C
K1.3 ■ 17 C	K2.1 ■ 49 C	K2.2 ■ 40 C	K2.3 ■ 32 B	K3.1 ■ 44 C	K3.2 ■ 33 C	K3.3 ■ 27 A	K4.1 ■ 40 B	K4.2 ■ 30 B	K4.3 ■ 22 B	K4.4 ■ 19 A	K4.5 ■ 16 A	K5.1 ■ 46 B	K5.2 ■ 34 B
K5.3 ■ 27 B	N1.1 ■ 81 E	N1.2 ■ 60 D	N1.3 ■ 41 D	N2.1 ■ 41 C	N2.2 ■ 37 C	N2.3 ■ 26 C	N3.1 ■ 43 C	N3.2 ■ 25 C	N3.3 ■ 13 C	N4.1 ■ 43 C	S1.1 ■ 30 B	S1.2 ■ 25 B	S2.1 ■ 20 A
S3.1 ■ 15 A	S4.1 ■ 12 A												

DCON MS tolerancia h6.

Product	DC (mm)	DCON MS (mm)	APMX (mm)	OAL (mm)	NOF	LU (mm)	DN (mm)
C1352.0	2.00	6.00	7.00	54.0	2	18.00	1.80
C1353.0	3.00	6.00	8.00	56.0	2	20.00	2.80
C1354.0	4.00	6.00	11.00	63.0	2	27.00	3.70
C1355.0	5.00	6.00	13.00	68.0	2	32.00	4.70
C1356.0	6.00	6.00	13.00	68.0	2	32.00	5.70
C1358.0	8.00	10.00	19.00	88.0	2	48.00	7.50
C13510.0	10.00	10.00	22.00	95.0	2	54.50	9.50
C13512.0	12.00	12.00	26.00	110.0	2	64.50	11.50
C13514.0	14.00	12.00	26.00	110.0	2	64.50	11.50
C13516.0	16.00	16.00	32.00	123.0	2	74.50	15.50
C13518.0	18.00	16.00	32.00	123.0	2	74.50	15.50
C13520.0	20.00	20.00	38.00	141.0	2	90.50	19.50

C122



Fresa HSS-E de 2 Filos Serie Extra Larga, Acabado Brillante

Fresa con longitud de corte larga de 2 filos que proporciona alta rigidez para fresado de ranuras estándar. Diseñada para fresado de ranuras profundas en áreas de difícil acceso en aceros blandos y materiales no féreos.

HSS-E	N	NOF 2
	λ 30°	γ 12°
DIN 1835A	Bright	DC e8

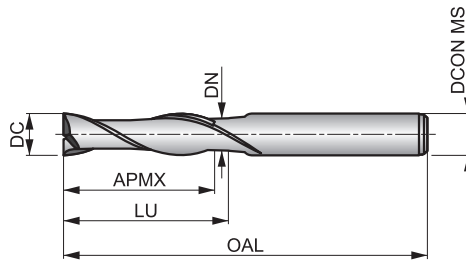

Grupo de Material de la pieza adecuado. Valores de inicio de la velocidad de corte (m/min) y código alfabético. Las tablas con avances por diente y factores de corrección en la pag. 261.

P1.1 ■ 41 C	P1.2 ■ 46 C	P1.3 ■ 48 C	P2.1 ■ 35 C	P2.2 ■ 31 C	P3.1 ■ 28 C	P3.2 ■ 23 B	P4.1 ■ 17 B	M1.1 ■ 27 C	M1.2 ■ 23 C	M2.1 ■ 24 C	M2.2 ■ 20 B	K1.1 ■ 25 C	K1.2 ■ 19 C
K1.3 ■ 14 C	K2.1 ■ 44 C	K2.2 ■ 36 C	K2.3 ■ 29 B	K3.1 ■ 39 C	K3.2 ■ 30 C	K3.3 ■ 24 A	K4.1 ■ 36 B	K4.2 ■ 27 B	K4.3 ■ 20 B	K4.4 ■ 17 A	K4.5 ■ 14 A	K5.1 ■ 41 B	K5.2 ■ 31 B
K5.3 ■ 24 B	N1.1 ■ 76 E	N1.2 ■ 57 D	N1.3 ■ 38 D	N2.1 ■ 38 C	N2.2 ■ 34 C	N2.3 ■ 25 C	N3.1 ■ 40 C	N3.2 ■ 23 C	N3.3 ■ 12 C	N4.1 ■ 40 C	S1.1 ■ 25 B	S1.2 ■ 20 B	S2.1 ■ 15 A
S3.1 ■ 11 A	S4.1 ■ 9 A												

DCON MS tolerancia h6.

Product	DC (mm)	DCON MS (mm)	APMX (mm)	OAL (mm)	NOF	LU (mm)	DN (mm)
C1225.0	5.00	5.00	22.00	65.0	2	–	–
C1226.0	6.00	6.00	27.00	75.0	2	–	–
C1227.0	7.00	8.00	33.00	85.0	2	–	–
C1228.0	8.00	8.00	33.00	85.0	2	–	–
C12210.0	10.00	10.00	40.00	95.0	2	–	–
C12212.0	12.00	12.00	45.00	110.0	2	–	–
C12214.0	14.00	12.00	52.00	125.0	2	–	–
C12216.0	16.00	16.00	58.00	140.0	2	69.50	15.50
C12218.0	18.00	16.00	65.00	150.0	2	76.50	15.50
C12220.0	20.00	20.00	70.00	160.0	2	85.50	19.50
C12222.0	22.00	20.00	75.00	170.0	2	90.50	19.50

C306



Fresa HSS-E-PM de 3 Filos para Ranurado, Acabado Brillante

Fresa con longitud de corte extra corta de 3 filos que proporciona alta rigidez y es adecuada para fresado de ranuras poco profundas y fresado en rampa. Su precisión la hace indicada para el fresado de chaveteros estándar con tolerancia P9. Versátil, se puede utilizar en aceros blandos y materiales no férreos.

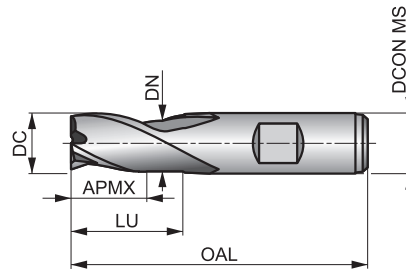

HSS-E PM	N	NOF 3
	λ 30°	γ 12°
DIN 1835B	Bright	DC e8
	DIN 327D	



Grupo de Material de la pieza adecuado. Valores de inicio de la velocidad de corte (m/min) y código alfabético. Las tablas con avances por diente y factores de corrección en la pag. 261.

P1.1 ■ 54 E	P1.2 ■ 61 E	P1.3 ■ 63 E	P2.1 ■ 47 E	P2.2 ■ 41 E	P3.1 ■ 38 E	P3.2 ■ 31 D	P4.1 ■ 23 D	M1.1 ■ 36 E	M1.2 ■ 30 E	M2.1 ■ 32 E	M2.2 ■ 26 D	K1.1 ■ 32 E	K1.2 ■ 24 E
K1.3 ■ 18 E	K2.1 ■ 59 E	K2.2 ■ 48 E	K2.3 ■ 38 D	K3.1 ■ 52 E	K3.2 ■ 40 E	K3.3 ■ 32 D	K4.1 ■ 48 D	K4.2 ■ 37 D	K4.3 ■ 27 D	K4.4 ■ 23 C	K4.5 ■ 19 C	K5.1 ■ 55 D	K5.2 ■ 41 D
K5.3 ■ 32 D	N1.3 ■ 50 F	N2.1 ■ 50 E	N2.2 ■ 45 E	N2.3 ■ 32 E	N3.1 ■ 52 E	N3.2 ■ 30 E	N3.3 ■ 16 E	N4.1 ■ 52 E	S1.1 ■ 33 D	S1.2 ■ 26 D	S2.1 ■ 20 C	S3.1 ■ 15 C	S4.1 ■ 12 C

DCON MS tolerancia h6.

Product	DC (mm)	DCON MS (mm)	APMX (mm)	OAL (mm)	NOF	LU (mm)	DN (mm)
C3063.0	3.00	6.00	5.00	49.0	3	-	-
C3064.0	4.00	6.00	7.00	51.0	3	-	-
C3065.0	5.00	6.00	8.00	52.0	3	-	-
C3066.0	6.00	6.00	8.00	52.0	3	-	-
C3067.0	7.00	10.00	10.00	60.0	3	-	-
C3068.0	8.00	10.00	11.00	61.0	3	-	-
C3069.0	9.00	10.00	11.00	61.0	3	-	-
C30610.0	10.00	10.00	13.00	63.0	3	22.50	9.50
C30611.0	11.00	12.00	13.00	70.0	3	-	-
C30612.0	12.00	12.00	16.00	73.0	3	27.50	11.50
C30614.0	14.00	12.00	16.00	73.0	3	27.50	11.50
C30615.0	15.00	12.00	16.00	73.0	3	27.50	11.50
C30616.0	16.00	16.00	19.00	79.0	3	30.50	15.50
C30618.0	18.00	16.00	19.00	79.0	3	30.50	15.50
C30620.0	20.00	20.00	22.00	88.0	3	37.50	19.50
C30622.0	22.00	20.00	22.00	88.0	3	37.50	19.50
C30625.0	25.00	25.00	26.00	102.0	3	45.50	24.50
C30630.0	30.00	25.00	26.00	102.0	3	45.50	24.50

C353

DORMER



Fresa HSS-E-PM de 3 Filos para Ranurado, Recubrimiento Alcrona

Fresa con longitud de corte extra corta de 3 filos que proporciona alta rigidez y es adecuada para fresado de ranuras poco profundas y fresado en rampa. Su precisión la hace indicada para el fresado de chaveteros estándar con tolerancia P9. El recubrimiento Alcrona mejora el rendimiento y aumenta la vida de la herramienta.

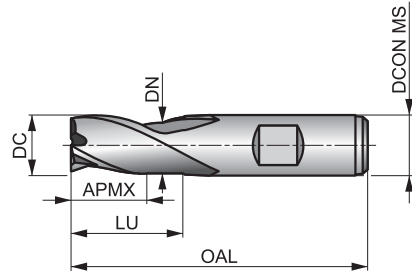

HSS-E PM	N	NOF 3
	λ 30°	γ 12°
	Alcrona	DC e8
	DIN 327D	



Grupo de Material de la pieza adecuado. Valores de inicio de la velocidad de corte (m/min) y código alfabético. Las tablas con avances por diente y factores de corrección en la pag. 261.

P1.1 ■ 133 E	P1.2 ■ 148 E	P1.3 ■ 154 E	P2.1 ■ 114 E	P2.2 ■ 100 E	P2.3 ■ 88 D	P3.1 ■ 88 E	P3.2 ■ 71 D	P3.3 ■ 60 D	P4.1 ■ 53 D	P4.2 ■ 45 D	P4.3 ▣ 37 D	M1.1 ▣ 69 E	M1.2 ▣ 58 E
M2.1 ▣ 61 E	M2.2 ▣ 50 D	M3.1 ▣ 52 D	M3.2 ▣ 45 D	M3.3 ▣ 41 C	M4.1 ▣ 30 C	K1.1 ■ 65 E	K1.2 ■ 48 E	K1.3 ■ 36 E	K2.1 ■ 117 E	K2.2 ■ 95 E	K2.3 ■ 76 D	K3.1 ■ 103 E	K3.2 ■ 79 E
K3.3 ■ 64 D	K4.1 ■ 96 D	K4.2 ■ 72 D	K4.3 ■ 53 D	K4.4 ■ 45 C	K4.5 ■ 38 C	K5.1 ■ 108 D	K5.2 ■ 82 D	K5.3 ■ 63 D	N1.3 ▣ 89 F	N2.1 ▣ 89 E	N2.2 ■ 80 E	N2.3 ■ 57 E	N3.1 ■ 93 E
N3.2 ■ 55 E	N3.3 ■ 28 E	N4.1 ▣ 93 E	S1.1 ■ 50 D	S1.2 ■ 40 D	S1.3 ▣ 20 C	S2.1 ■ 40 C	S2.2 ▣ 21 C	S3.1 ■ 30 C	S3.2 ▣ 15 C	S4.1 ■ 23 C	S4.2 ▣ 12 C		

DCON MS tolerancia h6.

Product	DC (mm)	DCON MS (mm)	APMX (mm)	OAL (mm)	NOF	LU (mm)	DN (mm)
C3533.0	3.00	6.00	5.00	49.0	3	-	-
C3533.5	3.50	6.00	6.00	50.0	3	-	-
C3534.0	4.00	6.00	7.00	51.0	3	-	-
C3534.5	4.50	6.00	7.00	51.0	3	-	-
C3535.0	5.00	6.00	8.00	52.0	3	-	-
C3535.5	5.50	6.00	8.00	52.0	3	-	-
C3536.0	6.00	6.00	8.00	52.0	3	-	-
C3536.5	6.50	10.00	10.00	60.0	3	-	-
C3537.0	7.00	10.00	10.00	60.0	3	-	-
C3537.5	7.50	10.00	10.00	60.0	3	-	-
C3538.0	8.00	10.00	11.00	61.0	3	-	-
C3538.5	8.50	10.00	11.00	61.0	3	-	-
C3539.0	9.00	10.00	11.00	61.0	3	-	-
C3539.5	9.50	10.00	11.00	61.0	3	-	-
C35310.0	10.00	10.00	13.00	63.0	3	22.50	9.50
C35311.0	11.00	12.00	13.00	70.0	3	-	-
C35312.0	12.00	12.00	16.00	73.0	3	27.50	11.50
C35313.0	13.00	12.00	16.00	73.0	3	27.50	11.50
C35314.0	14.00	12.00	16.00	73.0	3	27.50	11.50
C35315.0	15.00	12.00	16.00	73.0	3	27.50	11.50
C35316.0	16.00	16.00	19.00	79.0	3	30.50	15.50
C35318.0	18.00	16.00	19.00	79.0	3	30.50	15.50
C35320.0	20.00	20.00	22.00	88.0	3	37.50	19.50
C35322.0	22.00	20.00	22.00	88.0	3	37.50	19.50
C35325.0	25.00	25.00	26.00	102.0	3	45.50	24.50



Product	DC	DCON MS	APMX	OAL	NOF	LU	DN
	(mm)	(mm)	(mm)	(mm)		(mm)	(mm)
C35328.0	28.00	25.00	26.00	102.0	3	45.50	24.50
C35330.0	30.00	25.00	26.00	102.0	3	45.50	24.50

C367



Fresa HSS-E-PM de 3 Filos para Ranurado, Recubrimiento Alcrona

Fresa con longitud de corte extra corta de 3 filos, con hélice de 40°. Su geometría afilada está diseñada para mecanizar aceros blandos y especialmente aceros inoxidables de resistencia media y alta y materiales no férreos. Su precisión la hace indicada para el fresado de chaveteros estándar con tolerancia P9. El recubrimiento Alcrona aumenta la vida de la herramienta.

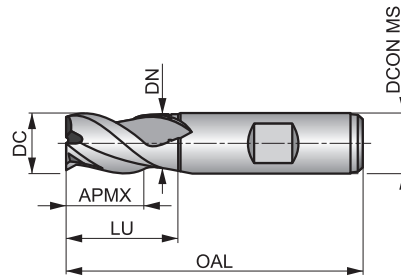

HSS-E PM	N	NOF 3
	λ 40°	γ 15°
DIN 1835B	Alcrona	DC e8
	DIN 327D	



Grupo de Material de la pieza adecuado. Valores de inicio de la velocidad de corte (m/min) y código alfabético. Las tablas con avances por diente y factores de corrección en la pag. 261.

P1.1 ■ 135 E	P1.2 ■ 151 E	P1.3 ■ 157 E	P2.1 ■ 116 E	P2.2 ■ 102 E	P3.1 ■ 94 E	P3.2 ■ 75 D	P4.1 ■ 56 D	M1.1 ■ 92 E	M1.2 ■ 78 E	M2.1 ■ 82 E	M2.2 ■ 67 D	M2.3 ■ 56 D	M3.1 ■ 64 D
M3.2 ■ 55 D	M3.3 ■ 50 C	M4.1 ■ 35 C	M4.2 ■ 30 C	N1.1 ■ 177 G	N1.2 ■ 133 F	N1.3 ■ 89 F	N2.1 ■ 89 E	N2.2 ■ 180 E	N2.3 ■ 157 E	N3.1 ■ 93 E	N3.2 ■ 55 E	N3.3 ■ 28 E	N4.1 ■ 93 E
S1.1 ■ 50 D													

DCON MS tolerancia h6.

Product	DC (mm)	DCON MS (mm)	APMX (mm)	OAL (mm)	NOF	LU (mm)	DN (mm)
C3672.0	2.00	6.00	4.00	48.0	3	—	—
C3673.0	3.00	6.00	5.00	49.0	3	—	—
C3674.0	4.00	6.00	7.00	51.0	3	—	—
C3675.0	5.00	6.00	8.00	52.0	3	—	—
C3676.0	6.00	6.00	8.00	52.0	3	—	—
C3677.0	7.00	10.00	10.00	60.0	3	—	—
C3678.0	8.00	10.00	11.00	61.0	3	—	—
C36710.0	10.00	10.00	13.00	63.0	3	22.50	9.50
C36711.0	11.00	12.00	13.00	70.0	3	—	—
C36712.0	12.00	12.00	16.00	73.0	3	27.50	11.50
C36714.0	14.00	12.00	16.00	73.0	3	27.50	11.50
C36716.0	16.00	16.00	19.00	79.0	3	30.50	15.50
C36718.0	18.00	16.00	19.00	79.0	3	30.50	15.50
C36720.0	20.00	20.00	22.00	88.0	3	37.50	19.50

C305



Fresa HSS-E-PM de 3 Filos para Ranurado, Acabado Brillante

Fresa con longitud de corte corta de 3 filos, que proporciona alta rigidez en el fresado de ranuras. Su precisión la hace indicada para el fresado de chaveteros estándar con tolerancia P9. Adecuada también para perfilado y fresado en rampa en aceros blandos, materiales no féreos y aleaciones termorresistentes de resistencia media.

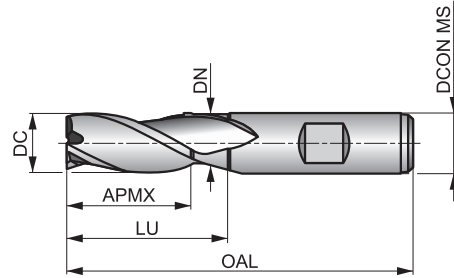

HSS-E PM	N	NOF 3
	λ 30°	γ 12°
DIN 1835B	Bright	DC e8
	DIN 844K	



Grupo de Material de la pieza adecuado. Valores de inicio de la velocidad de corte (m/min) y código alfabético. Las tablas con avances por diente y factores de corrección en la pag. 261.

P1.1 ■ 52 D	P1.2 ■ 58 D	P1.3 ■ 60 D	P2.1 ■ 44 D	P2.2 ■ 39 D	P3.1 ■ 36 D	P3.2 ■ 29 C	P4.1 ■ 21 C	M1.1 ■ 36 D	M1.2 ■ 30 D	M2.1 ■ 32 D	M2.2 ■ 26 C	K1.1 ■ 30 D	K1.2 ■ 22 D
K1.3 ■ 17 D	K2.1 ■ 55 D	K2.2 ■ 45 D	K2.3 ■ 36 C	K3.1 ■ 49 D	K3.2 ■ 37 D	K3.3 ■ 30 B	K4.1 ■ 45 C	K4.2 ■ 34 C	K4.3 ■ 25 C	K4.4 ■ 22 B	K4.5 ■ 18 B	K5.1 ■ 51 C	K5.2 ■ 39 C
K5.3 ■ 30 C	N1.3 ■ 48 E	N2.1 ■ 48 D	N2.2 ■ 43 D	N2.3 ■ 31 D	N3.1 ■ 50 D	N3.2 ■ 29 D	N3.3 ■ 15 D	N4.1 ■ 50 D	S1.1 ■ 29 C	S1.2 ■ 24 C	S2.1 ■ 17 B	S3.1 ■ 13 B	S4.1 ■ 10 B

DCON MS tolerancia h6.

Product	DC (mm)	DCON MS (mm)	APMX (mm)	OAL (mm)	NOF	LU (mm)	DN (mm)
C3052.0	2.00	6.00	7.00	51.0	3	-	-
C3052.5	2.50	6.00	8.00	52.0	3	-	-
C3053.0	3.00	6.00	8.00	52.0	3	-	-
C3053.5	3.50	6.00	10.00	54.0	3	-	-
C3054.0	4.00	6.00	11.00	55.0	3	-	-
C3054.5	4.50	6.00	11.00	55.0	3	-	-
C3055.0	5.00	6.00	13.00	57.0	3	-	-
C3055.5	5.50	6.00	13.00	57.0	3	-	-
C3056.0	6.00	6.00	13.00	57.0	3	-	-
C3056.5	6.50	10.00	16.00	66.0	3	-	-
C3057.0	7.00	10.00	16.00	66.0	3	-	-
C3057.5	7.50	10.00	16.00	66.0	3	-	-
C3058.0	8.00	10.00	19.00	69.0	3	-	-
C3058.5	8.50	10.00	19.00	69.0	3	-	-
C3059.0	9.00	10.00	19.00	69.0	3	-	-
C30510.0	10.00	10.00	22.00	72.0	3	31.50	9.50
C30511.0	11.00	12.00	22.00	79.0	3	-	-
C30512.0	12.00	12.00	26.00	83.0	3	37.50	11.50
C30513.0	13.00	12.00	26.00	83.0	3	37.50	11.50
C30514.0	14.00	12.00	26.00	83.0	3	37.50	11.50
C30515.0	15.00	12.00	26.00	83.0	3	37.50	11.50
C30516.0	16.00	16.00	32.00	92.0	3	43.50	15.50
C30517.0	17.00	16.00	32.00	92.0	3	43.50	15.50
C30518.0	18.00	16.00	32.00	92.0	3	43.50	15.50
C30519.0	19.00	16.00	32.00	92.0	3	43.50	15.50
C30520.0	20.00	20.00	38.00	104.0	3	53.50	19.50
C30522.0	22.00	20.00	38.00	104.0	3	53.50	19.50



Product	DC	DCON MS	APMX	OAL	NOF	LU	DN
	(mm)	(mm)	(mm)	(mm)		(mm)	(mm)
C30525.0	25.00	25.00	45.00	121.0	3	–	–
C30528.0	28.00	25.00	45.00	121.0	3	–	–
C30532.0	32.00	32.00	53.00	133.0	3	–	–

C352



Fresa HSS-E-PM de 3 Filos para Ranurado, Recubrimiento Alcrona

Fresa con longitud de corte corta de 3 filos, que proporciona alta rigidez en el fresado de ranuras. Su precisión la hace indicada para el fresado de chaveteros estándar con tolerancia P9. Adecuada también para perfilado y fresado en rampa en materiales blandos. El recubrimiento Alcrona aumenta la vida de la herramienta.

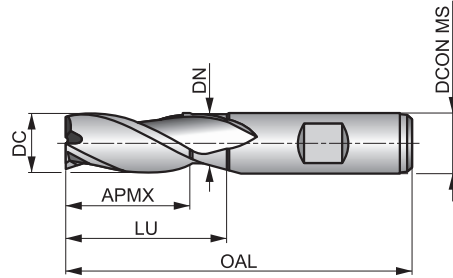

HSS-E-PM	N	NOF 3
	λ 30°	γ 12°
DIN 1835B	Alcrona	DC e8
	DIN 844K	



Grupo de Material de la pieza adecuado. Valores de inicio de la velocidad de corte (m/min) y código alfabético. Las tablas con avances por diente y factores de corrección en la pag. 261.

P1.1 ■ 126 D	P1.2 ■ 141 D	P1.3 ■ 146 D	P2.1 ■ 108 D	P2.2 ■ 95 D	P2.3 ■ 84 C	P3.1 ■ 81 D	P3.2 ■ 65 C	P3.3 ■ 55 C	P4.1 ■ 48 C	P4.2 ■ 41 C	P4.3 ▣ 34 C	M1.1 ▣ 69 D	M1.2 ▣ 58 D
M2.1 ▣ 61 D	M2.2 ▣ 50 C	M3.1 ▣ 47 C	M3.2 ▣ 40 C	M3.3 ▣ 36 B	M4.1 ▣ 25 B	K1.1 ■ 60 D	K1.2 ■ 44 D	K1.3 ■ 33 D	K2.1 ■ 111 D	K2.2 ■ 90 D	K2.3 ■ 72 C	K3.1 ■ 98 D	K3.2 ■ 75 D
K3.3 ■ 61 B	K4.1 ■ 91 C	K4.2 ■ 68 C	K4.3 ■ 50 C	K4.4 ■ 43 B	K4.5 ■ 36 B	K5.1 ■ 103 C	K5.2 ■ 77 C	K5.3 ■ 60 C	N1.3 ▣ 89 E	N2.1 ▣ 89 D	N2.2 ■ 80 D	N2.3 ■ 57 D	N3.1 ■ 93 D
N3.2 ■ 55 D	N3.3 ■ 28 D	N4.1 ▣ 93 D	S1.1 ■ 45 C	S1.2 ■ 35 C	S1.3 ▣ 15 B	S2.1 ■ 33 B	S2.2 ▣ 14 B	S3.1 ■ 25 B	S3.2 ▣ 10 B	S4.1 ■ 20 B	S4.2 ▣ 8 B		

DCON MS tolerancia h6.

Product	DC (mm)	DCON MS (mm)	APMX (mm)	OAL (mm)	NOF	LU (mm)	DN (mm)
C3523.0	3.00	6.00	8.00	52.0	3	—	—
C3524.0	4.00	6.00	11.00	55.0	3	—	—
C3525.0	5.00	6.00	13.00	57.0	3	—	—
C3526.0	6.00	6.00	13.00	57.0	3	—	—
C3528.0	8.00	10.00	19.00	69.0	3	—	—
C35210.0	10.00	10.00	22.00	72.0	3	31.50	9.50
C35212.0	12.00	12.00	26.00	83.0	3	37.50	11.50
C35214.0	14.00	12.00	26.00	83.0	3	37.50	11.50
C35216.0	16.00	16.00	32.00	92.0	3	43.50	15.50
C35218.0	18.00	16.00	32.00	92.0	3	43.50	15.50
C35220.0	20.00	20.00	38.00	104.0	3	53.50	19.50

C346



Fresa HSS-E de 3 Filos Serie Larga, Acabado Brillante

Fresa con longitud de corte larga de 3 filos que proporciona alta rigidez para el fresado de ranuras estándar y perfilado en aceros blandos y materiales no ferreos. Serie larga diseñada para mecanizar ranuras profundas y paredes en zonas de difícil acceso.

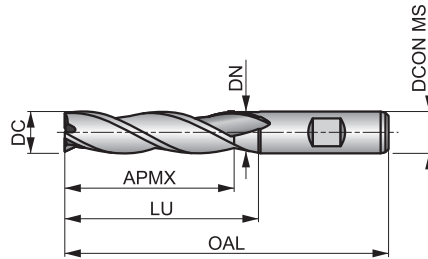

HSS-E	N	NOF 3
	λ 30°	γ 12°
DIN 1835B	Bright	DC e8
	DIN 844L	



Grupo de Material de la pieza adecuado. Valores de inicio de la velocidad de corte (m/min) y código alfabético. Las tablas con avances por diente y factores de corrección en la pag. 261.

P1.1 ■ 40 C	P1.2 ■ 45 C	P1.3 ■ 46 C	P2.1 ■ 34 C	P2.2 ■ 30 C	P3.1 ■ 28 C	P3.2 ■ 22 B	P4.1 ■ 16 B	M1.1 ■ 27 C	M1.2 ■ 23 C	M2.1 ■ 24 C	M2.2 ■ 20 B	K1.1 ■ 25 C	K1.2 ■ 19 C
K1.3 ■ 14 C	K2.1 ■ 43 C	K2.2 ■ 35 C	K2.3 ■ 28 B	K3.1 ■ 38 C	K3.2 ■ 29 C	K3.3 ■ 24 A	K4.1 ■ 35 B	K4.2 ■ 27 B	K4.3 ■ 20 B	K4.4 ■ 17 A	K4.5 ■ 14 A	K5.1 ■ 40 B	K5.2 ■ 30 B
K5.3 ■ 23 B	N1.1 ■ 76 E	N1.2 ■ 57 D	N1.3 ■ 38 D	N3.1 ■ 40 C	N3.2 ■ 23 C	N3.3 ■ 12 C	N4.1 ■ 40 C	S1.1 ■ 25 B	S1.2 ■ 20 B	S2.1 ■ 13 A	S3.1 ■ 10 A	S4.1 ■ 8 A	

DCON MS tolerancia h6.

Product	DC (mm)	DCON MS (mm)	APMX (mm)	OAL (mm)	NOF	LU (mm)	DN (mm)
C3463.0	3.00	6.00	12.00	56.0	3	—	—
C3464.0	4.00	6.00	19.00	63.0	3	—	—
C3465.0	5.00	6.00	24.00	68.0	3	—	—
C3466.0	6.00	6.00	24.00	68.0	3	—	—
C3467.0	7.00	10.00	30.00	80.0	3	—	—
C3468.0	8.00	10.00	38.00	88.0	3	—	—
C3469.0	9.00	10.00	38.00	88.0	3	—	—
C34610.0	10.00	10.00	45.00	95.0	3	—	—
C34611.0	11.00	12.00	45.00	102.0	3	—	—
C34612.0	12.00	12.00	53.00	110.0	3	—	—
C34613.0	13.00	12.00	53.00	110.0	3	64.50	11.50
C34615.0	15.00	12.00	53.00	110.0	3	64.50	11.50
C34616.0	16.00	16.00	63.00	123.0	3	74.50	15.50
C34620.0	20.00	20.00	75.00	141.0	3	90.50	19.50

Código de Material (BMC)	HSS-E PM	HSS-E	HSS-E	HSS-E PM	HSS-E PM	HSS-E PM	HSS-E PM	HSS-E PM						
Perfil de la fresa	HRA	NF	NF	NRA	HRA	NRA	HRA	NRA						
Número de canales (NOF)	NOF 3-4	NOF 4	NOF 4	NOF 4	NOF 4-6	NOF 4-6	NOF 3-6	NOF 4-6						
Longitud de corte														
Ángulo de hélice (FHA)	λ 35°	λ 30°	λ 30°	λ 35°	λ 35°	λ 35°	λ 35°	λ 35°						
Ángulo de hélice (FHA)	λ 35°	λ 30°	λ 30°	λ 35°	λ 35°	λ 35°	λ 35°	λ 35°						
Ángulo de incidencia radial (GAMF)	γ 12°	γ 12°	γ 12°	γ 12°	γ 12°	γ 12°	γ 12°	γ 12°						
Mango	DIN 18358	DIN 18358	DIN 18358	DIN 18358	DIN 18358	DIN 18358	DIN 18358	DIN 18358						
Recubrimiento	Alcrona	Bright	TiCN	Bright	Alcrona	Alcrona	Alcrona	Alcrona						
Clase de tolerancia del diámetro de corte (TCDC)	DC k12	DC k12	DC k12	DC k12	DC k12	DC k12	DC k12	DC k12						
Dirección														
Grupo básico estándar (BSG)	DIN 844K	DIN 844K	DIN 844K	DIN 844K	DIN 844K	DIN 844K	DIN 844L	DIN 844L						

Código de Familia de Producto		C922	C400	C413	C407	C428	C908	C492	C948					
Gama de diámetros de corte PSF		6.00 – 24.00	6.00 – 20.00	6.00 – 20.00	6.00 – 20.00	6.00 – 32.00	6.00 – 32.00	6.00 – 30.00	6.00 – 32.00					
P	P1		■	■	■									
	P2	■	■	■	■	■	■	■	■					
	P3	■	■	■	■	■	■	■	■					
	P4	■	■	■	■	■	■	■	■					
M	M1	■	■	■	■	■	■	■	■					
	M2	■	■	■	■	■	■	■	■					
	M3	■	■	■	■	■	■	■	■					
	M4	■	■	■	■	■	■	■	■					
K	K1	■	■	■	■	■	■	■	■					
	K2	■	■	■	■	■	■	■	■					
	K3	■	■	■	■	■	■	■	■					
	K4	■	■	■	■	■	■	■	■					
	K5	■	■	■	■	■	■	■	■					
N	N1		■	■										
	N2		■	■										
	N3	■	■	■	■	■	■	■	■					
	N4		■	■										
	N5													
S	S1	■	■	■	■	■	■	■	■					
	S2	■	■	■	■	■	■	■	■					
	S3	■	■	■	■	■	■	■	■					
	S4	■	■	■	■	■	■	■	■					
H	H1													
	H2													
	H3													
	H4													

C922



Fresa HSS-E-PM de 3-4 Filos para Desbaste, Recubrimiento Alcrona

Fresa con longitud de corte corta de 3 o 4 filos, con cuello reducido en diámetros grandes y perfil HRA para romper la viruta y proporcionar operaciones de desbaste eficientes. La hélice a 35° reduce vibraciones y aumenta el rendimiento. El recubrimiento Alcrona aumenta la vida de la herramienta y mejora el rendimiento.

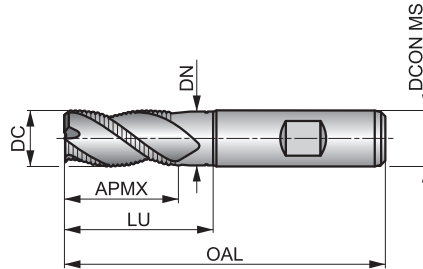

HSS-E PM	HRA	NOF 3-4
	λ 35°	γ 12°
DIN 1835B	Alcrona	DC k12
	DIN 844K	



Grupo de Material de la pieza adecuado. Valores de inicio de la velocidad de corte (m/min) y código alfabético. Las tablas con avances por diente y factores de corrección en la pag. 261.

P2.2 ■ 95 F	P2.3 ■ 84 E	P3.1 ■ 81 F	P3.2 ■ 65 E	P3.3 ■ 55 E	P4.1 ■ 48 E	P4.2 ■ 41 E	P4.3 ■ 34 E	M1.1 ■ 69 F	M1.2 ■ 58 F	M2.1 ■ 61 F	M2.2 ■ 50 E	M3.1 ■ 47 E	M3.2 ■ 40 E
M3.3 ■ 36 D	M4.1 ■ 25 D	K1.1 ■ 60 F	K1.2 ■ 44 F	K1.3 ■ 33 F	K2.1 ■ 111 F	K2.2 ■ 90 F	K2.3 ■ 72 E	K3.1 ■ 98 F	K3.2 ■ 75 F	K3.3 ■ 61 E	K4.1 ■ 91 E	K4.2 ■ 68 E	K4.3 ■ 50 E
K4.4 ■ 43 D	K4.5 ■ 36 D	K5.1 ■ 103 E	K5.2 ■ 77 E	K5.3 ■ 60 E	N3.1 ■ 93 F	N3.2 ■ 55 F	S1.1 ■ 45 E	S1.2 ■ 35 E	S1.3 ■ 15 D	S2.1 ■ 33 D	S2.2 ■ 14 D	S3.1 ■ 25 D	S3.2 ■ 10 D
S4.1 ■ 20 D	S4.2 ■ 8 D												

DCON MS tolerancia h6.

Product	DC (mm)	DCON MS (mm)	APMX (mm)	OAL (mm)	NOF	LU (mm)	DN (mm)
C9226.0	6.00	6.00	13.00	57.0	3	-	-
C9227.0	7.00	10.00	16.00	66.0	3	-	-
C9228.0	8.00	10.00	19.00	69.0	3	-	-
C9229.0	9.00	10.00	19.00	69.0	3	-	-
C92210.0	10.00	10.00	22.00	72.0	3	31.50	9.50
C92211.0	11.00	12.00	22.00	79.0	3	-	-
C92212.0	12.00	12.00	26.00	83.0	3	37.50	11.50
C92213.0	13.00	12.00	26.00	83.0	3	37.50	11.50
C92214.0	14.00	12.00	26.00	83.0	3	37.50	11.50
C92215.0	15.00	12.00	26.00	83.0	3	37.50	11.50
C92216.0	16.00	16.00	32.00	92.0	3	43.50	15.50
C92218.0	18.00	16.00	32.00	92.0	3	43.50	15.50
C92220.0	20.00	20.00	38.00	104.0	3	53.50	19.50
C92222.0	22.00	20.00	38.00	104.0	3	53.50	19.50
C92224.0	24.00	25.00	45.00	121.0	4	64.50	23.50

C400



Fresa HSS-E de 4 Filos para Desbaste, Acabado Brillante

Fresa con longitud de corte corta de 4 filos sin corte al centro, únicamente para operaciones de desbaste periférico. El perfil NF está diseñado para romper la viruta y proporcionar operaciones de desbaste eficientes. La hélice a 30° reduce vibraciones y mejora el rendimiento en el desbaste de aceros blandos.

HSS-E	NF	NOF 4
	λ 30°	γ 12°
DIN 1835B	Bright	DC k12
	DIN 844K	

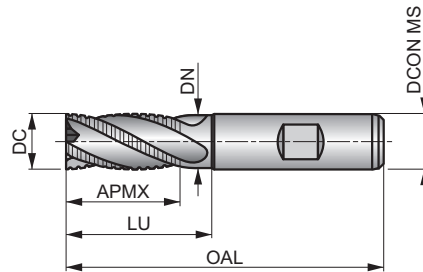

Grupo de Material de la pieza adecuado. Valores de inicio de la velocidad de corte (m/min) y código alfabético. Las tablas con avances por diente y factores de corrección en la pag. 261.

P1.1 ■ 46 E	P1.2 ■ 52 E	P1.3 ■ 54 E	P2.1 ■ 40 E	P2.2 ■ 35 E	P3.1 ▣ 32 E	P3.2 ▣ 26 D	P4.1 ▣ 19 D	M1.1 ▣ 34 E	M1.2 ▣ 29 E	M2.1 ▣ 31 E	M2.2 ▣ 25 D	K1.1 ▣ 30 E	K1.2 ▣ 22 E
K1.3 ▣ 17 E	K2.1 ▣ 49 E	K2.2 ▣ 40 E	K2.3 ▣ 32 D	K3.1 ▣ 44 E	K3.2 ▣ 33 E	K3.3 ▣ 27 D	K4.1 ▣ 40 D	K4.2 ▣ 30 D	K4.3 ▣ 22 D	K4.4 ▣ 19 C	K4.5 ▣ 16 C	K5.1 ▣ 46 D	K5.2 ▣ 34 D
K5.3 ▣ 27 D	N1.3 ▣ 41 F	N2.1 ▣ 41 E	N2.2 ▣ 37 E	N2.3 ▣ 26 E	N3.1 ■ 43 E	N3.2 ■ 25 E	N3.3 ▣ 13 E	N4.1 ▣ 43 E	S1.1 ▣ 30 D	S1.2 ▣ 25 D	S2.1 ▣ 20 C	S3.1 ▣ 15 C	S4.1 ▣ 12 C

DCON MS tolerancia h6.

Product	DC (mm)	DCON MS (mm)	APMX (mm)	OAL (mm)	NOF	LU (mm)	DN (mm)
C4006.0	6.00	6.00	13.00	57.0	4	–	–
C4008.0	8.00	10.00	19.00	69.0	4	–	–
C40010.0	10.00	10.00	22.00	72.0	4	–	–
C40012.0	12.00	12.00	26.00	83.0	4	–	–
C40014.0	14.00	12.00	26.00	83.0	4	37.50	11.50
C40016.0	16.00	16.00	32.00	92.0	4	43.50	15.50
C40018.0	18.00	16.00	32.00	92.0	4	43.50	15.50
C40020.0	20.00	20.00	38.00	104.0	4	53.50	19.50

C413



Fresa HSS-E de 4 Filos para Desbaste, Recubrimiento TiCN

Fresa con longitud de corte corta de 4 filos, únicamente para operaciones de desbaste periférico. El perfil NF está diseñado para romper la viruta y proporcionar operaciones de desbaste eficientes. La hélice a 30° reduce vibraciones y mejora el rendimiento en operaciones de desbaste. El recubrimiento TiCN aumenta la vida de la herramienta y mejora el rendimiento en materiales duros y abrasivos.

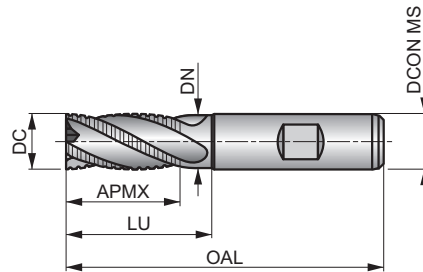

HSS-E	NF	NOF 4
	λ 30°	γ 12°
DIN 1835B	TiCN	DC k12
	DIN 844K	



Grupo de Material de la pieza adecuado. Valores de inicio de la velocidad de corte (m/min) y código alfabético. Las tablas con avances por diente y factores de corrección en la pag. 261.

P1.1 ■ 93 E	P1.2 ■ 104 E	P1.3 ■ 108 E	P2.1 ■ 80 E	P2.2 ■ 70 E	P2.3 ▣ 62 D	P3.1 ■ 59 E	P3.2 ■ 47 D	P3.3 ▣ 40 D	P4.1 ■ 35 D	P4.2 ▣ 30 D	P4.3 ▣ 24 D	M1.1 ▣ 48 E	M1.2 ▣ 41 E
M2.1 ▣ 43 E	M2.2 ▣ 35 D	M3.3 ▣ 21 C	M4.1 ▣ 20 C	K1.1 ■ 45 E	K1.2 ■ 33 E	K1.3 ■ 25 E	K2.1 ■ 80 E	K2.2 ■ 65 E	K2.3 ■ 52 D	K3.1 ■ 71 E	K3.2 ■ 54 E	K3.3 ■ 44 D	K4.1 ■ 66 D
K4.2 ■ 49 D	K4.3 ■ 36 D	K4.4 ■ 31 C	K4.5 ■ 26 C	K5.1 ■ 74 D	K5.2 ■ 56 D	K5.3 ■ 43 D	N1.3 ▣ 82 F	N2.1 ▣ 182 E	N2.2 ■ 74 E	N2.3 ■ 52 E	N3.1 ■ 86 E	N3.2 ■ 50 E	N3.3 ▣ 126 E
N4.1 ▣ 86 E	S1.1 ▣ 35 D	S1.2 ■ 30 D	S1.3 ▣ 10 C	S2.1 ■ 27 C	S2.2 ▣ 14 C	S3.1 ■ 20 C	S3.2 ▣ 10 C	S4.1 ■ 16 C	S4.2 ▣ 8 C				

DCON MS tolerancia h6.

Product	DC (mm)	DCON MS (mm)	APMX (mm)	OAL (mm)	NOF	LU (mm)	DN (mm)
C4136.0	6.00	6.00	13.00	57.0	4	–	–
C4138.0	8.00	10.00	19.00	69.0	4	–	–
C41310.0	10.00	10.00	22.00	72.0	4	–	–
C41312.0	12.00	12.00	26.00	83.0	4	–	–
C41314.0	14.00	12.00	26.00	83.0	4	37.50	11.50
C41316.0	16.00	16.00	32.00	92.0	4	43.50	15.50
C41318.0	18.00	16.00	32.00	92.0	4	43.50	15.50
C41320.0	20.00	20.00	38.00	104.0	4	53.50	19.50

C407

DORMER



Fresa HSS-E-PM de 4 Filos para Desbaste, Acabado Brillante

Fresa con longitud de corte corta de 4 filos, con cuello reducido en diámetros grandes y perfil NRA para romper la viruta y proporcionar operaciones de desbaste eficientes. La hélice a 35° reduce vibraciones y mejora el rendimiento en operaciones de desbaste.

HSS-E PM	NRA	NOF 4
	λ 35°	γ 12°
DIN 1835B	Bright	DC k12
	DIN 844K	

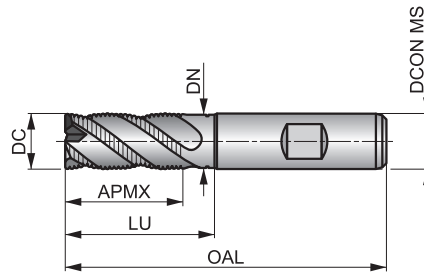

Grupo de Material de la pieza adecuado. Valores de inicio de la velocidad de corte (m/min) y código alfabético. Las tablas con avances por diente y factores de corrección en la pag. 261.

P1.1 ■ 50 G	P1.2 ■ 56 G	P1.3 ■ 58 G	P2.1 ■ 43 G	P2.2 ■ 38 G	P2.3 ■ 34 F	P3.1 ■ 32 G	P3.2 ■ 26 F	P3.3 ■ 22 F	P4.1 ■ 19 F	P4.2 ■ 16 F	P4.3 ■ 13 F	M1.1 ■ 34 G	M1.2 ■ 29 G
M2.1 ■ 31 G	M2.2 ■ 25 F	M3.1 ■ 24 F	M3.2 ■ 21 F	M3.3 ■ 19 E	M4.1 ■ 13 E	K1.1 ■ 30 G	K1.2 ■ 22 G	K1.3 ■ 17 G	K2.1 ■ 54 G	K2.2 ■ 44 G	K2.3 ■ 35 F	K3.1 ■ 48 G	K3.2 ■ 37 G
K3.3 ■ 30 F	K4.1 ■ 44 F	K4.2 ■ 33 F	K4.3 ■ 25 F	K4.4 ■ 21 E	K4.5 ■ 18 E	K5.1 ■ 50 F	K5.2 ■ 38 F	K5.3 ■ 29 F	N3.1 ■ 43 G	N3.2 ■ 25 G	S1.1 ■ 30 F	S1.2 ■ 25 F	S1.3 ■ 11 E
S2.1 ■ 19 E	S2.2 ■ 8 E	S3.1 ■ 14 E	S3.2 ■ 6 E	S4.1 ■ 11 E	S4.2 ■ 5 E								

DCON MS tolerancia h6.

Product	DC (mm)	DCON MS (mm)	APMX (mm)	OAL (mm)	NOF	LU (mm)	DN (mm)
C4076.0	6.00	6.00	13.00	57.0	4	–	–
C4077.0	7.00	10.00	16.00	66.0	4	–	–
C4078.0	8.00	10.00	19.00	69.0	4	–	–
C4079.0	9.00	10.00	19.00	69.0	4	–	–
C40710.0	10.00	10.00	22.00	72.0	4	31.50	9.50
C40711.0	11.00	12.00	22.00	79.0	4	–	–
C40712.0	12.00	12.00	26.00	83.0	4	37.50	11.50
C40713.0	13.00	12.00	26.00	83.0	4	37.50	11.50
C40714.0	14.00	12.00	26.00	83.0	4	37.50	11.50
C40716.0	16.00	16.00	32.00	92.0	4	43.50	15.50
C40718.0	18.00	16.00	32.00	92.0	4	43.50	15.50
C40720.0	20.00	20.00	38.00	104.0	4	53.50	19.50

C428



Fresa HSS-E-PM de Múltiples Filos para Desbaste, Recubrimiento Alcrona

Fresa con longitud de corte corta de 4 o 6 filos con cuello reducido en diámetros grandes y perfil HRA para romper la viruta y proporcionar operaciones de desbaste eficientes. La hélice a 35° reduce vibraciones y aumenta el rendimiento. El recubrimiento Alcrona aumenta la vida de la herramienta y mejora el rendimiento.

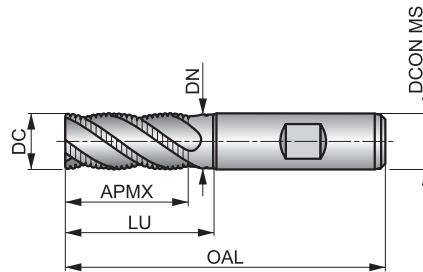

HSS-E PM	HRA	NOF 4-6
	λ 35°	γ 12°
DIN 1835B	Alcrona	DC k12
	DIN 844K	



Grupo de Material de la pieza adecuado. Valores de inicio de la velocidad de corte (m/min) y código alfabético. Las tablas con avances por diente y factores de corrección en la pag. 261.

P2.2 ■ 93 F	P2.3 ■ 82 E	P3.1 ■ 80 F	P3.2 ■ 64 E	P3.3 ■ 54 E	P4.1 ■ 48 E	P4.2 ■ 40 E	P4.3 ■ 33 E	M1.1 ■ 66 F	M1.2 ■ 56 F	M2.1 ■ 59 F	M2.2 ■ 48 E	M3.1 ■ 47 E	M3.2 ■ 40 E
M3.3 ■ 36 D	M4.1 ■ 26 D	K1.1 ■ 61 F	K1.2 ■ 45 F	K1.3 ■ 34 F	K2.1 ■ 108 F	K2.2 ■ 88 F	K2.3 ■ 70 E	K3.1 ■ 96 F	K3.2 ■ 73 F	K3.3 ■ 59 E	K4.1 ■ 89 E	K4.2 ■ 67 E	K4.3 ■ 49 E
K4.4 ■ 42 D	K4.5 ■ 35 D	K5.1 ■ 100 E	K5.2 ■ 76 E	K5.3 ■ 58 E	N3.1 ■ 116 F	N3.2 ■ 68 F	S1.1 ■ 46 E	S1.2 ■ 37 E	S1.3 ■ 16 D	S2.1 ■ 36 D	S2.2 ■ 16 D	S3.1 ■ 27 D	S3.2 ■ 11 D
S4.1 ■ 21 D	S4.2 ■ 9 D												

DCON MS tolerancia h6.

Product	DC (mm)	DCON MS (mm)	APMX (mm)	OAL (mm)	NOF	LU (mm)	DN (mm)
C4286.0	6.00	6.00	13.00	57.0	4	-	-
C4287.0	7.00	10.00	16.00	66.0	4	-	-
C4288.0	8.00	10.00	19.00	69.0	4	-	-
C4289.0	9.00	10.00	19.00	69.0	4	-	-
C42810.0	10.00	10.00	22.00	72.0	4	31.50	9.50
C42811.0	11.00	12.00	22.00	79.0	4	-	-
C42812.0	12.00	12.00	26.00	83.0	4	37.50	11.50
C42813.0	13.00	12.00	26.00	83.0	4	37.50	11.50
C42814.0	14.00	12.00	26.00	83.0	4	37.50	11.50
C42815.0	15.00	12.00	26.00	83.0	4	37.50	11.50
C42816.0	16.00	16.00	32.00	92.0	4	43.50	15.50
C42818.0	18.00	16.00	32.00	92.0	4	43.50	15.50
C42820.0	20.00	20.00	38.00	104.0	4	53.50	19.50
C42822.0	22.00	20.00	38.00	104.0	4	53.50	19.50
C42825.0	25.00	25.00	45.00	121.0	6	64.50	24.50
C42828.0	28.00	25.00	45.00	121.0	6	64.50	24.50
C42830.0	30.00	25.00	45.00	121.0	6	64.50	24.50
C42832.0	32.00	32.00	53.00	133.0	6	72.50	31.50

C908



Fresa HSS-E-PM de Múltiples Filos para Desbaste, Recubrimiento Alcrona

Fresa con longitud de corte corta de 4 o 6 filos, con cuello reducido en diámetros grandes y perfil NRA para romper la viruta y proporcionar operaciones de desbaste eficientes. La hélice a 35° reduce vibraciones y mejora el rendimiento en operaciones de desbaste. El recubrimiento Alcrona mejora el rendimiento y aumenta la vida de la herramienta.

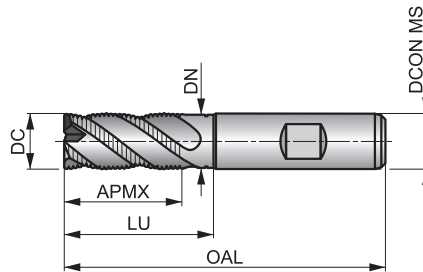

HSS-E PM	NRA	NOF 4-6
	λ 35°	γ 12°
DIN 1835B	Alcrona	DC k12
	DIN 844K	



Grupo de Material de la pieza adecuado. Valores de inicio de la velocidad de corte (m/min) y código alfabético. Las tablas con avances por diente y factores de corrección en la pag. 261.

P2.2 ■ 93 G	P2.3 ■ 82 F	P3.1 ■ 80 G	P3.2 ■ 64 F	P3.3 ■ 54 F	P4.1 ■ 48 F	P4.2 ■ 40 F	P4.3 ■ 33 F	M1.1 ■ 66 G	M1.2 ■ 56 G	M2.1 ■ 59 G	M2.2 ■ 48 F	M3.1 ■ 47 F	M3.2 ■ 40 F
M3.3 ■ 36 E	M4.1 ■ 26 E	K1.1 ■ 61 G	K1.2 ■ 45 G	K1.3 ■ 34 G	K2.1 ■ 108 G	K2.2 ■ 88 G	K2.3 ■ 70 F	K3.1 ■ 96 G	K3.2 ■ 73 G	K3.3 ■ 59 F	K4.1 ■ 89 F	K4.2 ■ 67 F	K4.3 ■ 49 F
K4.4 ■ 42 E	K4.5 ■ 35 E	K5.1 ■ 100 F	K5.2 ■ 76 F	K5.3 ■ 58 F	N3.1 ■ 93 G	N3.2 ■ 55 G	S1.1 ■ 46 F	S1.2 ■ 37 F	S1.3 ■ 16 E	S2.1 ■ 36 E	S2.2 ■ 16 E	S3.1 ■ 27 E	S3.2 ■ 11 E
S4.1 ■ 21 E	S4.2 ■ 9 E												

DCON MS tolerancia h6.

Product	DC (mm)	DCON MS (mm)	APMX (mm)	OAL (mm)	NOF	LU (mm)	DN (mm)
C9086.0	6.00	6.00	13.00	57.0	4	—	—
C9087.0	7.00	10.00	16.00	66.0	4	—	—
C9088.0	8.00	10.00	19.00	69.0	4	—	—
C9089.0	9.00	10.00	19.00	69.0	4	—	—
C90810.0	10.00	10.00	22.00	72.0	4	31.50	9.50
C90811.0	11.00	12.00	22.00	79.0	4	—	—
C90812.0	12.00	12.00	26.00	83.0	4	37.50	11.50
C90813.0	13.00	12.00	26.00	83.0	4	37.50	11.50
C90814.0	14.00	12.00	26.00	83.0	4	37.50	11.50
C90816.0	16.00	16.00	32.00	92.0	4	43.50	15.50
C90818.0	18.00	16.00	32.00	92.0	4	43.50	15.50
C90820.0	20.00	20.00	38.00	104.0	4	53.50	19.50
C90822.0	22.00	20.00	38.00	104.0	4	53.50	19.50
C90825.0	25.00	25.00	45.00	121.0	6	64.50	24.50
C90830.0	30.00	25.00	45.00	121.0	6	64.50	24.50
C90832.0	32.00	32.00	53.00	133.0	6	72.50	31.50

C492

DORMER



Fresa de HSS-E-PM con Múltiples Dientes de Serie Larga para Desbaste, Recubrimiento Alcrona

Fresa con longitud de corte larga de 3, 4 o 6 filos con perfil HRA para romper la viruta y proporcionar operaciones de desbaste eficientes en perfiles profundos. Cuello reducido en diámetros de 10 mm y superiores. La hélice a 35° reduce vibraciones y aumenta el rendimiento en desbaste. El recubrimiento Alcrona aumenta la vida de la herramienta y mejora el rendimiento.

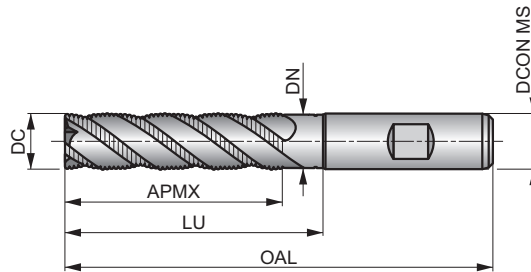

HSS-E PM	HRA	NOF 3-6
	λ 35°	γ 12°
DIN 1835B	Alcrona	DC k12
	DIN 844L	

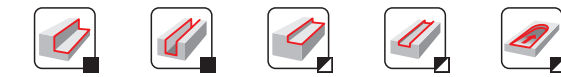

Grupo de Material de la pieza adecuado. Valores de inicio de la velocidad de corte (m/min) y código alfabético. Las tablas con avances por diente y factores de corrección en la pag. 261.

P2.2 ■ 83 E	P2.3 ■ 73 D	P3.1 ■ 72 E	P3.2 ■ 58 D	P3.3 ■ 49 D	P4.1 ■ 43 D	P4.2 ■ 37 D	P4.3 ■ 30 D	M1.1 ■ 59 E	M1.2 ■ 50 E	M2.1 ■ 53 E	M2.2 ■ 43 D	M3.1 ■ 42 D	M3.2 ■ 36 D
M3.3 ■ 32 C	M4.1 ■ 23 C	K1.1 ■ 55 E	K1.2 ■ 41 E	K1.3 ■ 31 E	K2.1 ■ 97 E	K2.2 ■ 79 E	K2.3 ■ 63 D	K3.1 ■ 86 E	K3.2 ■ 66 E	K3.3 ■ 53 D	K4.1 ■ 80 D	K4.2 ■ 60 D	K4.3 ■ 44 D
K4.4 ■ 38 C	K4.5 ■ 31 C	K5.1 ■ 90 D	K5.2 ■ 68 D	K5.3 ■ 52 D	N3.1 ■ 104 E	N3.2 ■ 61 E	S1.1 ■ 41 D	S1.2 ■ 34 D	S1.3 ■ 15 C	S2.1 ■ 32 C	S2.2 ■ 14 C	S3.1 ■ 24 C	S3.2 ■ 10 C
S4.1 ■ 19 C	S4.2 ■ 8 C												

DCON MS tolerancia h6.

Product	DC (mm)	DCON MS (mm)	APMX (mm)	OAL (mm)	NOF	LU (mm)	DN (mm)
C4926.0	6.00	6.00	24.00	68.0	3	—	—
C4928.0	8.00	10.00	38.00	88.0	3	—	—
C49210.0	10.00	10.00	45.00	95.0	4	54.50	9.50
C49212.0	12.00	12.00	53.00	110.0	4	64.50	11.50
C49214.0	14.00	12.00	53.00	110.0	4	64.50	11.50
C49216.0	16.00	16.00	63.00	123.0	4	74.50	15.50
C49218.0	18.00	16.00	63.00	123.0	4	74.50	15.50
C49220.0	20.00	20.00	75.00	141.0	4	90.50	19.50
C49222.0	22.00	20.00	75.00	141.0	4	90.50	19.50
C49225.0	25.00	25.00	90.00	166.0	6	109.50	24.50
C49230.0	30.00	25.00	90.00	166.0	6	109.50	24.50

C948



Fresa de HSS-E-PM con Múltiples Dientes de Serie Larga para Desbaste, Recubrimiento Alcrona

Fresa con longitud de corte larga de 4 o 6 filos, con perfil NRA para romper la viruta y proporcionar operaciones de desbaste eficientes en perfiles profundos. La hélice a 35° reduce vibraciones y mejora el rendimiento en operaciones de desbaste. Cuello reducido en diámetro 10 mm y superiores. El recubrimiento Alcrona mejora el rendimiento y aumenta la vida de la herramienta.

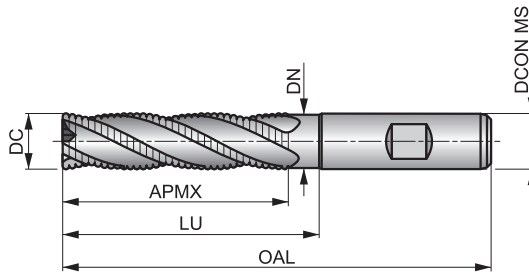

HSS-E PM	NRA	NOF 4-6
	λ 35°	γ 12°
DIN 1835B	Alcrona	DC k12
	DIN 844L	

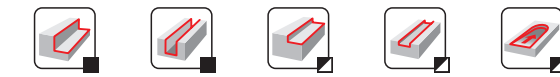

Grupo de Material de la pieza adecuado. Valores de inicio de la velocidad de corte (m/min) y código alfabético. Las tablas con avances por diente y factores de corrección en la pag. 261.

P2.2 ■ 83 F	P2.3 ■ 73 E	P3.1 ■ 72 F	P3.2 ■ 58 E	P3.3 ■ 49 E	P4.1 ■ 43 E	P4.2 ■ 37 E	P4.3 ■ 30 E	M1.1 ■ 59 F	M1.2 ■ 50 F	M2.1 ■ 53 F	M2.2 ■ 43 E	M3.1 ■ 42 E	M3.2 ■ 36 E
M3.3 ■ 32 D	M4.1 ■ 23 D	K1.1 ■ 55 F	K1.2 ■ 41 F	K1.3 ■ 31 F	K2.1 ■ 97 F	K2.2 ■ 79 F	K2.3 ■ 63 E	K3.1 ■ 86 F	K3.2 ■ 66 F	K3.3 ■ 53 E	K4.1 ■ 80 E	K4.2 ■ 60 E	K4.3 ■ 44 E
K4.4 ■ 38 D	K4.5 ■ 31 D	K5.1 ■ 90 E	K5.2 ■ 68 E	K5.3 ■ 52 E	N3.1 ■ 83 F	N3.2 ■ 49 F	S1.1 ■ 41 E	S1.2 ■ 34 E	S1.3 ■ 15 D	S2.1 ■ 32 D	S2.2 ■ 14 D	S3.1 ■ 24 D	S3.2 ■ 10 D
S4.1 ■ 19 D	S4.2 ■ 8 D												

DCON MS tolerancia h6.

Product	DC (mm)	DCON MS (mm)	APMX (mm)	OAL (mm)	NOF	LU (mm)	DN (mm)
C9486.0	6.00	6.00	24.00	68.0	4	—	—
C9488.0	8.00	10.00	38.00	88.0	4	—	—
C94810.0	10.00	10.00	45.00	95.0	4	54.50	9.50
C94812.0	12.00	12.00	53.00	110.0	4	64.50	11.50
C94814.0	14.00	12.00	53.00	110.0	4	64.50	11.50
C94816.0	16.00	16.00	63.00	123.0	4	74.50	15.50
C94818.0	18.00	16.00	63.00	123.0	4	74.50	15.50
C94820.0	20.00	20.00	75.00	141.0	4	90.50	19.50
C94825.0	25.00	25.00	90.00	166.0	6	109.50	24.50
C94832.0	32.00	32.00	106.00	186.0	6	125.50	31.50

Código de Material (BMC)	HSS-E PM	HSS-E PM	HSS-E PM	HSS-E PM	HSS-E PM	HSS-E PM												
Perfil de la fresa	N	N	N	N	N	N												
Número de canales (NOF)	NOF 3-4	NOF 3-6	NOF 4-6	NOF 4-5	NOF 4-6	NOF 4-6												
Longitud de corte																		
Ángulo de hélice (FHA)	λ 45°	λ 45°	λ 30°	λ 30°	λ 30°	λ 30°												
Ángulo de hélice (FHA)	λ 45°	λ 45°	λ 30°	λ 30°	λ 30°	λ 30°												
Ángulo de incidencia radial (GAMF)	γ 12°	γ 12°	γ 12°	γ 12°	γ 12°	γ 12°												
Mango	DIN 1835B	DIN 1835B	DIN 1835B	DIN 1835B	DIN 1835B	DIN 1835B												
Recubrimiento	Bright	Alcrona	Bright	TiCN	Bright	TiCN												
Clase de tolerancia del diámetro de corte (TCDC)	DC k10	DC k10	DC k10	DC k10	DC k10	DC k10												
Dirección																		
Grupo básico estándar (BSG)	DIN 844K	DIN 844K	DIN 844K	DIN 844K	DIN 844L	DIN 844L												
Código de Familia de Producto	C299	C907	C247	C246	C273	C295												
Gama de diámetros de corte PSF	3.00 – 20.00	3.00 – 32.00	2.00 – 40.00	2.00 – 25.00	2.00 – 40.00	2.00 – 40.00												
P	P1																	
	P2	■	■	■	■	■												
	P3	■	■	■	■	■												
	P4	■	■	■	■	■	■											
M	M1	■	■	■	■	■												
	M2	■	■	■	■	■												
	M3	■	■	■	■	■												
	M4	■	■	■	■	■	■											
K	K1	■	■	■	■	■												
	K2	■	■	■	■	■												
	K3	■	■	■	■	■												
	K4	■	■	■	■	■												
	K5	■	■	■	■	■												
N	N1			■	■	■												
	N2			■	■	■												
	N3	■	■	■	■	■												
	N4			■	■	■												
	N5			■	■	■												
S	S1	■	■	■	■	■												
	S2	■	■	■	■	■												
	S3	■	■	■	■	■												
	S4	■	■	■	■	■												
H	H1																	
	H2																	
	H3																	
	H4																	

C299

DORMER

Fresa HSS-E-PM de 3-4 Filos, Acabado Brillante

Fresa con longitud de corte corta de 3 o 4 filos que proporciona alta rigidez en aplicaciones de perfilado general y fresado en rampa. Con hélice de 45° y diseñada para mecanizar materiales de alta resistencia. Cuello reducido en diámetro 10 mm y superiores.

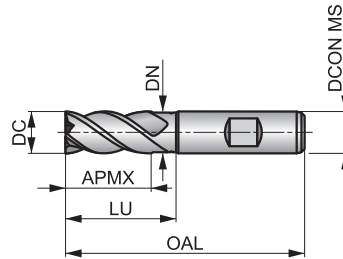

HSS-E PM	N	NOF 3-4
	λ 45°	γ 12°
DIN 1835B	Bright	DC k10
	DIN 844K	



Grupo de Material de la pieza adecuado. Valores de inicio de la velocidad de corte (m/min) y código alfabético. Las tablas con avances por diente y factores de corrección en la pag. 261.

P2.2 ■ 37 D	P2.3 ■ 33 C	P3.1 ■ 32 D	P3.2 ■ 26 C	P3.3 ■ 22 C	P4.1 ■ 19 C	P4.2 ■ 16 C	P4.3 ■ 13 C	M1.1 ■ 36 D	M1.2 ■ 30 D	M2.1 ■ 32 D	M2.2 ■ 26 C	M3.1 ■ 24 C	M3.2 ■ 21 C
M3.3 ■ 19 B	M4.1 ■ 13 B	K1.1 ■ 30 D	K1.2 ■ 22 D	K1.3 ■ 17 D	K2.1 ■ 55 D	K2.2 ■ 45 D	K2.3 ■ 36 C	K3.1 ■ 49 D	K3.2 ■ 37 D	K3.3 ■ 30 B	K4.1 ■ 45 C	K4.2 ■ 34 C	K4.3 ■ 25 C
K4.4 ■ 22 B	K4.5 ■ 18 B	K5.1 ■ 51 C	K5.2 ■ 39 C	K5.3 ■ 30 C	N3.1 ■ 43 D	N3.2 ■ 25 D	S1.1 ■ 29 C	S1.2 ■ 57 C	S1.3 ■ 10 B	S2.1 ■ 17 B	S2.2 ■ 7 B	S3.1 ■ 13 B	S3.2 ■ 5 B
S4.1 ■ 10 B	S4.2 ■ 4 B												

DCON MS tolerancia h6.

Product	DC (mm)	DCON MS (mm)	APMX (mm)	OAL (mm)	NOF	LU (mm)	DN (mm)
C2993.0	3.00	6.00	8.00	52.0	3	—	—
C2994.0	4.00	6.00	11.00	55.0	3	—	—
C2995.0	5.00	6.00	13.00	57.0	3	—	—
C2996.0	6.00	6.00	13.00	57.0	3	—	—
C2998.0	8.00	10.00	19.00	69.0	4	—	—
C29910.0	10.00	10.00	22.00	72.0	4	31.50	9.50
C29912.0	12.00	12.00	26.00	83.0	4	37.50	11.50
C29914.0	14.00	12.00	26.00	83.0	4	37.50	11.50
C29916.0	16.00	16.00	32.00	92.0	4	43.50	15.50
C29920.0	20.00	20.00	38.00	104.0	4	53.50	19.50

C907

DORMER



Fresa HSS-E-PM de Múltiples Filos, Recubrimiento Alcrona

Fresa con longitud de corte corta de 3, 4, 5 o 6 filos que proporciona alta rigidez en aplicaciones de perfilado general y fresado en rampa. Con hélice de 45° y diseñada para mecanizar materiales de alta resistencia. Cuello reducido en diámetro 10 mm y superiores. El recubrimiento Alcrona mejora el rendimiento y aumenta la vida de la herramienta.

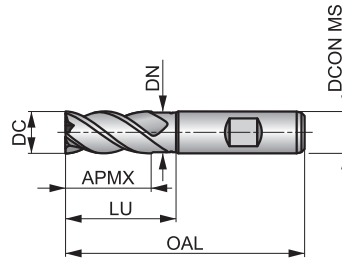

HSS-E PM	N	NOF 3-6
	λ 45°	γ 12°
DIN 1835B	Alcrona	DC k10
	DIN 844K	



Grupo de Material de la pieza adecuado. Valores de inicio de la velocidad de corte (m/min) y código alfabético. Las tablas con avances por diente y factores de corrección en la pag. 261.

P2.2 ■ 95 D	P2.3 ■ 84 C	P3.1 ■ 81 D	P3.2 ■ 65 C	P3.3 ■ 55 C	P4.1 ■ 48 C	P4.2 ■ 41 C	P4.3 ■ 34 C	M1.1 ■ 69 D	M1.2 ■ 58 D	M2.1 ■ 61 D	M2.2 ■ 50 C	M3.1 ■ 47 C	M3.2 ■ 40 C
M3.3 ■ 36 B	M4.1 ■ 25 B	K1.1 ■ 60 D	K1.2 ■ 44 D	K1.3 ■ 33 D	K2.1 ■ 111 D	K2.2 ■ 90 D	K2.3 ■ 72 C	K3.1 ■ 98 D	K3.2 ■ 75 D	K3.3 ■ 61 B	K4.1 ■ 91 C	K4.2 ■ 68 C	K4.3 ■ 50 C
K4.4 ■ 43 B	K4.5 ■ 36 B	K5.1 ■ 103 C	K5.2 ■ 77 C	K5.3 ■ 60 C	N3.1 ■ 93 D	N3.2 ■ 55 D	S1.1 ■ 45 C	S1.2 ■ 85 C	S1.3 ■ 15 B	S2.1 ■ 33 B	S2.2 ■ 14 B	S3.1 ■ 25 B	S3.2 ■ 10 B
S4.1 ■ 20 B	S4.2 ■ 8 B												

DCON MS tolerancia h6.

Product	DC (mm)	DCON MS (mm)	APMX (mm)	OAL (mm)	NOF	LU (mm)	DN (mm)
C9073.0	3.00	6.00	8.00	52.0	3	—	—
C9074.0	4.00	6.00	11.00	55.0	3	—	—
C9075.0	5.00	6.00	13.00	57.0	3	—	—
C9076.0	6.00	6.00	13.00	57.0	3	—	—
C9078.0	8.00	10.00	19.00	69.0	4	—	—
C90710.0	10.00	10.00	22.00	72.0	4	31.50	9.50
C90712.0	12.00	12.00	26.00	83.0	4	37.50	11.50
C90714.0	14.00	12.00	26.00	83.0	4	37.50	11.50
C90716.0	16.00	16.00	32.00	92.0	4	43.50	15.50
C90718.0	18.00	16.00	32.00	92.0	4	43.50	15.50
C90720.0	20.00	20.00	38.00	104.0	4	53.50	19.50
C90722.0	22.00	20.00	38.00	104.0	5	53.50	19.50
C90725.0	25.00	25.00	45.00	121.0	5	64.50	24.50
C90728.0	28.00	25.00	45.00	121.0	6	64.50	24.50
C90730.0	30.00	25.00	45.00	121.0	6	64.50	24.50
C90732.0	32.00	32.00	53.00	133.0	6	72.50	31.50

C247



Fresa HSS-E-PM de Múltiples Filos, Acabado Brillante

Fresa con longitud de corte corta de 4, 5 o 6 filos que proporciona alta rigidez en operaciones de perfilado general y fresado en rampa en aceros blandos y materiales no férreos.

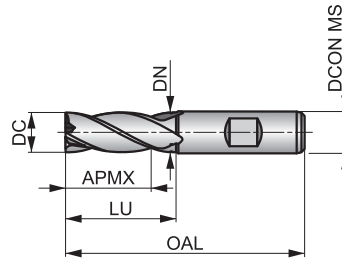

HSS-E PM	N	NOF 4-6
	λ 30°	γ 12°
DIN 1835B	Bright	DC k10
	DIN 844K	



Grupo de Material de la pieza adecuado. Valores de inicio de la velocidad de corte (m/min) y código alfabético. Las tablas con avances por diente y factores de corrección en la pag. 261.

P1.1 ■ 53 D	P1.2 ■ 59 D	P1.3 ■ 61 D	P2.1 ■ 45 D	P2.2 ■ 40 D	P3.1 ■ 36 D	P3.2 ■ 29 C	P4.1 ■ 22 C	M1.1 ■ 34 D	M1.2 ■ 29 D	M2.1 ■ 31 D	M2.2 ■ 25 C	K1.1 ■ 30 D	K1.2 ■ 22 D
K1.3 ■ 17 D	K2.1 ■ 55 D	K2.2 ■ 45 D	K2.3 ■ 36 C	K3.1 ■ 49 D	K3.2 ■ 37 D	K3.3 ■ 30 B	K4.1 ■ 45 C	K4.2 ■ 34 C	K4.3 ■ 25 C	K4.4 ■ 22 B	K4.5 ■ 18 B	K5.1 ■ 51 C	K5.2 ■ 39 C
K5.3 ■ 30 C	N1.1 ■ 95 F	N1.2 ■ 71 E	N1.3 ■ 48 E	N2.1 ■ 48 D	N2.2 ■ 43 D	N2.3 ■ 31 D	N3.1 ■ 50 D	N3.2 ■ 29 D	N3.3 ■ 15 D	N4.1 ■ 50 D	S1.1 ■ 30 C	S1.2 ■ 25 C	S2.1 ■ 20 B
S3.1 ■ 15 B	S4.1 ■ 12 B												

DCON MS tolerancia h6.

Product	DC (inch)	DC (mm)	DCON MS (mm)	APMX (mm)	OAL (mm)	NOF	LU (mm)	DN (mm)
C2472.0	—	2.00	6.00	7.00	51.0	4	—	—
C2472.5	—	2.50	6.00	8.00	52.0	4	—	—
C2473.0	—	3.00	6.00	8.00	52.0	4	—	—
C2471/8 ²⁾	1/8	3.18	6.00	10.00	54.0	4	—	—
C2473.5	—	3.50	6.00	10.00	54.0	4	—	—
C2474.0	—	4.00	6.00	11.00	55.0	4	—	—
C2474.5	—	4.50	6.00	11.00	55.0	4	—	—
C2473/16 ²⁾	3/16	4.76	6.00	13.00	57.0	4	—	—
C2475.0	—	5.00	6.00	13.00	57.0	4	—	—
C2475.5	—	5.50	6.00	13.00	57.0	4	—	—
C2476.0	—	6.00	6.00	13.00	57.0	4	—	—
C2471/4 ²⁾	1/4	6.35	10.00	16.00	66.0	4	—	—
C2476.5	—	6.50	10.00	16.00	66.0	4	—	—
C2477.0	—	7.00	10.00	16.00	66.0	4	—	—
C2477.5	—	7.50	10.00	16.00	66.0	4	—	—
C2475/16 ²⁾	5/16	7.94	10.00	19.00	69.0	4	—	—
C2478.0	—	8.00	10.00	19.00	69.0	4	—	—
C2478.5	—	8.50	10.00	19.00	69.0	4	—	—
C2479.0	—	9.00	10.00	19.00	69.0	4	—	—
C2479.5	—	9.50	10.00	19.00	69.0	4	—	—
C2473/8 ²⁾	3/8	9.52	10.00	22.00	72.0	4	31.50	9.50
C24710.0	—	10.00	10.00	22.00	72.0	4	31.50	9.50
C24711.0	—	11.00	12.00	22.00	79.0	4	—	—
C24712.0	—	12.00	12.00	26.00	83.0	4	37.50	11.50
C2471/2 ²⁾	1/2	12.70	12.00	26.00	83.0	4	37.50	11.50



Product	DC	DC	DCON MS	APMX	OAL	NOF	LU	DN
	(inch)	(mm)	(mm)	(mm)	(mm)		(mm)	(mm)
C24713.0	–	13.00	12.00	26.00	83.0	4	37.50	11.50
C24714.0	–	14.00	12.00	26.00	83.0	4	37.50	11.50
C2479/16²⁾	9/16	14.29	12.00	26.00	83.0	4	37.50	11.50
C24715.0	–	15.00	12.00	26.00	83.0	4	37.50	11.50
C2475/8²⁾	5/8	15.88	16.00	32.00	92.0	4	43.50	15.50
C24716.0	–	16.00	16.00	32.00	92.0	4	43.50	15.50
C24717.0	–	17.00	16.00	32.00	92.0	4	43.50	15.50
C24718.0	–	18.00	16.00	32.00	92.0	4	43.50	15.50
C24719.0	–	19.00	16.00	32.00	92.0	4	43.50	15.50
C2473/4²⁾	3/4	19.05	20.00	38.00	104.0	4	53.50	18.50
C24720.0	–	20.00	20.00	38.00	104.0	4	53.50	19.50
C24721.0	–	21.00	20.00	38.00	104.0	4	53.50	19.50
C24722.0	–	22.00	20.00	38.00	104.0	5	53.50	19.50
C2477/8²⁾	7/8	22.22	20.00	38.00	104.0	5	53.50	19.50
C24723.0	–	23.00	20.00	38.00	104.0	5	53.50	19.50
C24724.0	–	24.00	25.00	45.00	121.0	5	64.50	23.50
C24725.0	–	25.00	25.00	45.00	121.0	5	64.50	24.50
C2471²⁾	1"	25.40	25.00	45.00	121.0	5	64.50	24.50
C24726.0	–	26.00	25.00	45.00	121.0	6	64.50	24.50
C24728.0	–	28.00	25.00	45.00	121.0	6	64.50	24.50
C24730.0	–	30.00	25.00	45.00	121.0	6	64.50	24.50
C24732.0	–	32.00	32.00	53.00	133.0	6	72.50	31.50
C24736.0¹⁾	–	36.00	32.00	53.00	133.0	6	72.50	31.50
C24740.0¹⁾	–	40.00	40.00	63.00	155.0	6	84.50	39.00

¹⁾ Disponible solo en HSS-E; sin corte al centro²⁾ DC tolerancia +0.0025 pulgadas / -0.0005 pulgadas

C246



Fresa HSS-E-PM de Múltiples Filos, Recubrimiento TiCN

Fresa con longitud de corte corta de 4 o 5 filos que proporciona alta rigidez para perfilado en general y operaciones de fresado en rampa. El recubrimiento TiCN incrementa la vida útil y mejora el rendimiento en materiales duros y abrasivos.

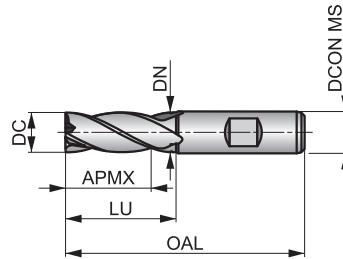

HSS-E PM	N	NOF 4-5
	λ 30°	γ 12°
DIN 1835B	TiCN	DC k10
	DIN 844K	



Grupo de Material de la pieza adecuado. Valores de inicio de la velocidad de corte (m/min) y código alfabético. Las tablas con avances por diente y factores de corrección en la pag. 261.

P1.1 ■ 113 D	P1.2 ■ 126 D	P1.3 ■ 131 D	P2.1 ■ 97 D	P2.2 ■ 85 D	P2.3 ▣ 75 C	P3.1 ■ 74 D	P3.2 ■ 59 C	P3.3 ▣ 50 C	P4.1 ■ 44 C	P4.2 ▣ 37 C	P4.3 ▣ 31 C	M1.1 ▣ 62 D	M1.2 ▣ 52 D
M2.1 ▣ 55 D	M2.2 ▣ 45 C	M3.3 ▣ 26 B	M4.1 ▣ 25 B	K1.1 ■ 55 D	K1.2 ■ 41 D	K1.3 ■ 31 D	K2.1 ■ 97 D	K2.2 ■ 79 D	K2.3 ■ 63 C	K3.1 ■ 86 D	K3.2 ■ 66 D	K3.3 ■ 53 B	K4.1 ■ 80 C
K4.2 ■ 60 C	K4.3 ■ 44 C	K4.4 ■ 38 B	K4.5 ■ 31 B	K5.1 ■ 90 C	K5.2 ■ 68 C	K5.3 ■ 52 C	N1.1 ▣ 159 F	N1.2 ▣ 120 E	N1.3 ▣ 80 E	N2.1 ▣ 80 D	N2.2 ■ 72 D	N2.3 ■ 51 D	N3.1 ■ 84 D
N3.2 ■ 50 D	N3.3 ■ 25 D	N4.1 ▣ 84 D	S1.1 ■ 43 C	S1.2 ■ 35 C	S1.3 ▣ 15 B	S2.1 ■ 32 B	S2.2 ▣ 14 B	S3.1 ■ 24 B	S3.2 ▣ 10 B	S4.1 ■ 19 B	S4.2 ▣ 8 B		

DCON MS tolerancia h6.

Product	DC (mm)	DCON MS (mm)	APMX (mm)	OAL (mm)	NOF	LU (mm)	DN (mm)
C2462.0	2.00	6.00	7.00	51.0	4	—	—
C2463.0	3.00	6.00	8.00	52.0	4	—	—
C2464.0	4.00	6.00	11.00	55.0	4	—	—
C2465.0	5.00	6.00	13.00	57.0	4	—	—
C2466.0	6.00	6.00	13.00	57.0	4	—	—
C2467.0	7.00	10.00	16.00	66.0	4	—	—
C2468.0	8.00	10.00	19.00	69.0	4	—	—
C24610.0	10.00	10.00	22.00	72.0	4	31.50	9.50
C24611.0	11.00	12.00	22.00	79.0	4	—	—
C24612.0	12.00	12.00	26.00	83.0	4	37.50	11.50
C24613.0	13.00	12.00	26.00	83.0	4	37.50	11.50
C24614.0	14.00	12.00	26.00	83.0	4	37.50	11.50
C24615.0	15.00	12.00	26.00	83.0	4	37.50	11.50
C24616.0	16.00	16.00	32.00	92.0	4	43.50	15.50
C24618.0	18.00	16.00	32.00	92.0	4	43.50	15.50
C24620.0	20.00	20.00	38.00	104.0	4	53.50	19.50
C24622.0	22.00	20.00	38.00	104.0	5	53.50	19.50
C24625.0	25.00	25.00	45.00	121.0	5	64.50	24.50

C273



Fresa de HSS-E-PM con Múltiples Dientes de Serie Larga, Acabado Brillante

Fresa con longitud de corte larga de 4, 5 o 6 filos, que proporciona alta rigidez en el fresado en acabado de perfiles profundos en aceros blandos y materiales no féreos, como el aluminio y las aleaciones de titanio de resistencia media.

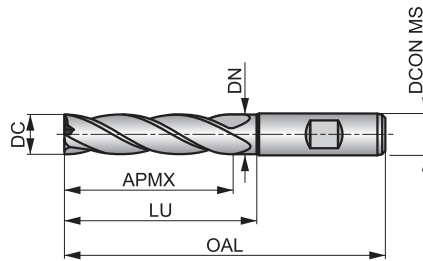

HSS-E PM	N	NOF 4-6
	λ 30°	γ 12°
DIN 1835B	Bright	DC k10
	DIN 844L	

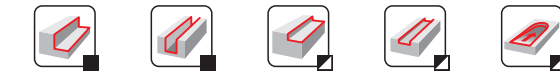

Grupo de Material de la pieza adecuado. Valores de inicio de la velocidad de corte (m/min) y código alfabético. Las tablas con avances por diente y factores de corrección en la pag. 261.

P1.1 ■ 46 C	P1.2 ■ 52 C	P1.3 ■ 54 C	P2.1 ■ 40 C	P2.2 ■ 35 C	P3.1 ■ 32 C	P3.2 ■ 26 B	P4.1 ■ 19 B	M1.1 ■ 14 C	M1.2 ■ 12 C	M2.1 ■ 12 C	M2.2 ■ 10 B	K1.1 ■ 25 C	K1.2 ■ 19 C
K1.3 ■ 14 C	K2.1 ■ 49 C	K2.2 ■ 40 C	K2.3 ■ 32 B	K3.1 ■ 44 C	K3.2 ■ 33 C	K3.3 ■ 27 A	K4.1 ■ 40 B	K4.2 ■ 30 B	K4.3 ■ 22 B	K4.4 ■ 19 A	K4.5 ■ 16 A	K5.1 ■ 46 B	K5.2 ■ 34 B
K5.3 ■ 27 B	N1.1 ■ 81 E	N1.2 ■ 60 D	N1.3 ■ 41 D	N2.1 ■ 41 C	N2.2 ■ 37 C	N2.3 ■ 26 C	N3.1 ■ 43 C	N3.2 ■ 25 C	N3.3 ■ 13 C	N4.1 ■ 43 C	S1.1 ■ 25 B	S1.2 ■ 20 B	S2.1 ■ 13 A
S3.1 ■ 10 A	S4.1 ■ 8 A												

DCON MS tolerancia h6.

Product	DC (inch)	DC (mm)	DCON MS (mm)	APMX (mm)	OAL (mm)	NOF	LU (mm)	DN (mm)
C2732.0	—	2.00	6.00	10.00	54.0	4	—	—
C2732.5	—	2.50	6.00	12.00	56.0	4	—	—
C2733.0	—	3.00	6.00	12.00	56.0	4	—	—
C2731/8 ²⁾	1/8	3.18	6.00	15.00	59.0	4	—	—
C2733.5	—	3.50	6.00	15.00	59.0	4	—	—
C2734.0	—	4.00	6.00	19.00	63.0	4	—	—
C2734.5	—	4.50	6.00	19.00	63.0	4	—	—
C2733/16 ²⁾	3/16	4.76	6.00	24.00	68.0	4	—	—
C2735.0	—	5.00	6.00	24.00	68.0	4	—	—
C2735.5	—	5.50	6.00	24.00	68.0	4	—	—
C2736.0	—	6.00	6.00	24.00	68.0	4	—	—
C2731/4 ²⁾	1/4	6.35	10.00	30.00	80.0	4	—	—
C2737.0	—	7.00	10.00	30.00	80.0	4	—	—
C2738.0	—	8.00	10.00	38.00	88.0	4	—	—
C2739.0	—	9.00	10.00	38.00	88.0	4	—	—
C2733/8 ²⁾	3/8	9.52	10.00	45.00	95.0	4	54.50	9.50
C27310.0	—	10.00	10.00	45.00	95.0	4	54.50	9.50
C27311.0	—	11.00	12.00	45.00	102.0	4	—	—
C27312.0	—	12.00	12.00	53.00	110.0	4	64.50	11.50
C2731/2 ²⁾	1/2	12.70	12.00	53.00	110.0	4	64.50	11.50
C27313.0	—	13.00	12.00	53.00	110.0	4	64.50	11.50
C27314.0	—	14.00	12.00	53.00	110.0	4	64.50	11.50
C27315.0	—	15.00	12.00	53.00	110.0	4	64.50	11.50
C2735/8 ²⁾	5/8	15.88	16.00	63.00	123.0	4	74.50	15.50
C27316.0	—	16.00	16.00	63.00	123.0	4	74.50	15.50

Product	DC	DC	D CON MS	APMX	OAL	NOF	LU	DN
	(inch)	(mm)	(mm)	(mm)	(mm)		(mm)	(mm)
C27318.0	–	18.00	16.00	63.00	123.0	4	74.50	15.50
C2733/4 ²⁾	3/4	19.05	20.00	75.00	141.0	4	90.50	18.50
C27320.0	–	20.00	20.00	75.00	141.0	4	90.50	19.50
C27322.0	–	22.00	20.00	75.00	141.0	5	90.50	19.50
C27325.0	–	25.00	25.00	90.00	166.0	5	109.50	24.50
C2731 ²⁾	1"	25.40	25.00	90.00	166.0	5	109.50	24.50
C27330.0	–	30.00	25.00	90.00	166.0	6	109.50	24.50
C27332.0	–	32.00	32.00	106.00	186.0	6	125.50	31.50
C27340.0 ¹⁾	–	40.00	40.00	125.00	217.0	6	146.50	39.00

¹⁾ Disponible solo en HSS-E; sin corte al centro

²⁾ DC tolerancia +0.0025 pulgadas / -0.0005 pulgadas

C295



Fresa de HSS-E-PM con Múltiples Dientes de Serie Larga, Recubrimiento TiCN

Fresa con longitud de corte larga de 4, 5 o 6 filos, que proporciona alta rigidez en el fresado en acabado de perfiles profundos. El recubrimiento TiCN incrementa la vida de la herramienta y mejora el rendimiento cuando se mecanizan materiales duros y abrasivos.

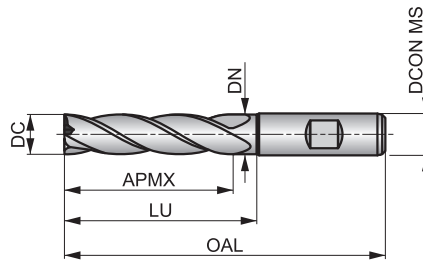

HSS-E PM	N	NOF 4-6
	λ 30°	γ 12°
DIN 1835B	TiCN	DC k10
	DIN 844L	



Grupo de Material de la pieza adecuado. Valores de inicio de la velocidad de corte (m/min) y código alfabético. Las tablas con avances por diente y factores de corrección en la pag. 261.

P1.1 ■ 99 C	P1.2 ■ 111 C	P1.3 ■ 115 C	P2.1 ■ 85 C	P2.2 ■ 75 C	P2.3 ▣ 66 B	P3.1 ■ 66 C	P3.2 ■ 53 B	P3.3 ▣ 45 B	P4.1 ■ 40 B	P4.2 ▣ 34 B	P4.3 ▣ 27 B	M1.1 ▣ 55 C	M1.2 ▣ 46 C
M2.1 ▣ 49 C	M2.2 ▣ 40 B	M3.3 ▣ 21 A	M4.1 ▣ 20 A	K1.1 ■ 50 C	K1.2 ■ 37 C	K1.3 ■ 28 C	K2.1 ■ 86 C	K2.2 ■ 70 C	K2.3 ■ 56 B	K3.1 ■ 76 C	K3.2 ■ 58 C	K3.3 ■ 47 A	K4.1 ■ 71 B
K4.2 ■ 53 B	K4.3 ■ 39 B	K4.4 ■ 33 A	K4.5 ■ 28 A	K5.1 ■ 80 B	K5.2 ■ 60 B	K5.3 ■ 46 B	N1.1 ▣ 139 E	N1.2 ▣ 105 D	N1.3 ▣ 70 D	N2.1 ▣ 70 C	N2.2 ■ 63 C	N2.3 ■ 45 C	N3.1 ■ 73 C
N3.2 ■ 43 C	N3.3 ■ 22 C	N4.1 ▣ 73 C	S1.1 ■ 40 B	S1.2 ■ 30 B	S1.3 ▣ 15 A	S2.1 ■ 27 A	S2.2 ▣ 14 A	S3.1 ■ 20 A	S3.2 ▣ 10 A	S4.1 ■ 16 A	S4.2 ▣ 8 A		

DCON MS tolerancia h6.

Product	DC (mm)	DCON MS (mm)	APMX (mm)	OAL (mm)	NOF	LU (mm)	DN (mm)
C2952.0	2.00	6.00	10.00	54.0	4	—	—
C2953.0	3.00	6.00	12.00	56.0	4	—	—
C2954.0	4.00	6.00	19.00	63.0	4	—	—
C2955.0	5.00	6.00	24.00	68.0	4	—	—
C2956.0	6.00	6.00	24.00	68.0	4	—	—
C2957.0	7.00	10.00	30.00	80.0	4	—	—
C2958.0	8.00	10.00	38.00	88.0	4	—	—
C2959.0	9.00	10.00	38.00	88.0	4	—	—
C29510.0	10.00	10.00	45.00	95.0	4	54.50	9.50
C29512.0	12.00	12.00	53.00	110.0	4	64.50	11.50
C29515.0	15.00	12.00	53.00	110.0	4	64.50	11.50
C29516.0	16.00	16.00	63.00	123.0	4	74.50	15.50
C29518.0	18.00	16.00	63.00	123.0	4	74.50	15.50
C29520.0	20.00	20.00	75.00	141.0	4	90.50	19.50
C29525.0	25.00	25.00	90.00	166.0	5	109.50	24.50
C29530.0	30.00	25.00	90.00	166.0	6	109.50	24.50
C29532.0	32.00	32.00	106.00	186.0	6	125.50	31.50
C29540.0 ¹⁾	40.00	40.00	125.00	217.0	6	146.50	39.00

¹⁾ Disponible solo en HSS-E; sin corte al centro

Código de Material (BMC)	HSS-E PM	HSS-E	HSS-E																
Perfil de la fresa	N	N	N																
Número de canales (NOF)	NOF 3-5	NOF 2	NOF 2																
Longitud de corte																			
Ángulo de hélice (FHA)	λ 45°	λ 30°	λ 30°																
Ángulo de hélice (FHA)	λ 45°	λ 30°	λ 30°																
Ángulo de incidencia radial (GAMF)	γ 12°	γ 12°	γ 12°																
Mango																			
Recubrimiento	Alcrona	Bright	Bright																
Clase de tolerancia del diámetro de corte (TCDC)	DC k10	DC e8	DC e8																
Dirección																			
Grupo básico estándar (BSG)	DIN 844L	DIN 327D	DIN 844K																

Código de Familia de Producto		C920	C500	C505															
Gama de diámetros de corte PSF		6.00 – 25.00	2.00 – 20.00	3.00 – 30.00															
		46	47	48															
P	P1	■	■	■															
	P2	■	▣	▣															
	P3	■	▣	▣															
	P4	■	▣	▣															
M	M1	■	▣	▣															
	M2	■	▣	▣															
	M3	■																	
	M4	■																	
K	K1	■	▣	▣															
	K2	■	▣	▣															
	K3	■	▣	▣															
	K4	■	▣	▣															
	K5	■	▣	▣															
N	N1		▣	▣															
	N2		▣	▣															
	N3	■	■	■															
	N4		▣	▣															
	N5																		
S	S1	■	▣	▣															
	S2	■	▣	▣															
	S3	■	▣	▣															
	S4	■	▣	▣															
H	H1																		
	H2																		
	H3																		
	H4																		

C920

DORMER



Fresa de HSS-E-PM con Múltiples Dientes de Serie Larga, Recubrimiento Alcrona

Fresa con longitud de corte larga de 3, 4 o 5 filos diseñada para ofrecer rigidez en el acabado de perfiles profundos. Con hélice a 45° y diseñada para el mecanizado de materiales de alta resistencia. Cuello reducido en diámetros de 10 mm y superiores para evitar el contacto con la pieza. El recubrimiento Alcrona aumenta la vida de la herramienta.

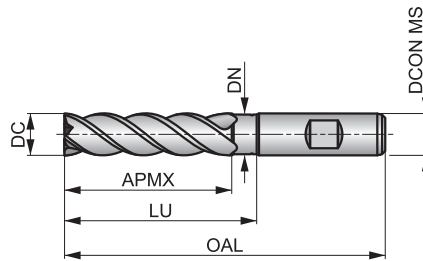

HSS-E PM	N	NOF 3-5
	λ 45°	γ 12°
DIN 1835B	Alcrona	DC k10
	DIN 844L	

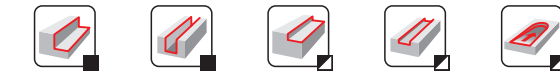

Grupo de Material de la pieza adecuado. Valores de inicio de la velocidad de corte (m/min) y código alfabético. Las tablas con avances por diente y factores de corrección en la pag. 261.

P2.2 ■ 85 C	P2.3 ■ 75 B	P3.1 ■ 74 C	P3.2 ■ 59 B	P3.3 ■ 50 B	P4.1 ■ 44 B	P4.2 ■ 37 B	P4.3 ■ 31 B	M1.1 ■ 62 C	M1.2 ■ 52 C	M2.1 ■ 55 C	M2.2 ■ 45 B	M3.1 ■ 41 B	M3.2 ■ 35 B
M3.3 ■ 32 A	M4.1 ■ 25 A	K1.1 ■ 55 C	K1.2 ■ 41 C	K1.3 ■ 31 C	K2.1 ■ 98 C	K2.2 ■ 80 C	K2.3 ■ 64 B	K3.1 ■ 87 C	K3.2 ■ 67 C	K3.3 ■ 54 A	K4.1 ■ 81 B	K4.2 ■ 61 B	K4.3 ■ 45 B
K4.4 ■ 38 A	K4.5 ■ 32 A	K5.1 ■ 91 B	K5.2 ■ 69 B	K5.3 ■ 53 B	N3.1 ■ 83 C	N3.2 ■ 49 C	S1.1 ■ 40 B	S1.2 ■ 35 B	S1.3 ■ 15 A	S2.1 ■ 33 A	S2.2 ■ 14 A	S3.1 ■ 25 A	S3.2 ■ 10 A
S4.1 ■ 20 A	S4.2 ■ 8 A												

DCON MS tolerancia h6.

Product	DC (mm)	DCON MS (mm)	APMX (mm)	OAL (mm)	NOF	LU (mm)	DN (mm)
C9206.0	6.00	6.00	24.00	68.0	3	—	—
C9208.0	8.00	10.00	38.00	88.0	4	—	—
C92010.0	10.00	10.00	45.00	95.0	4	54.50	9.50
C92012.0	12.00	12.00	53.00	110.0	4	64.50	11.50
C92014.0	14.00	12.00	53.00	110.0	4	64.50	11.50
C92016.0	16.00	16.00	63.00	123.0	4	74.50	15.50
C92020.0	20.00	20.00	75.00	141.0	4	90.50	19.50
C92025.0	25.00	25.00	90.00	166.0	5	109.50	24.50

C500

DORMER



Fresa HSS-E de 2 Filos con Punta Esférica, Acabado Brillante

Fresa con longitud de corte extra corta de 2 filos que proporciona alta rigidez para incrementar la resistencia y reducir vibraciones. Geometría diseñada para el contorneado de superficies complejas en máquinas CNC. Adecuada para aceros blandos, materiales no féreos y aleaciones de titanio de resistencia media. Cuello rebajado a partir de Ø14.

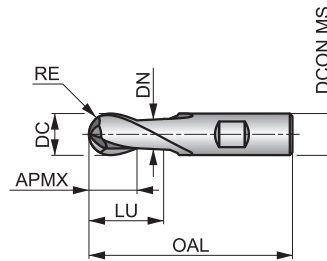

HSS-E	N	NOF 2
	λ 30°	γ 12°
DIN 1835B	Bright	DC e8
	DIN 327D	



Grupo de Material de la pieza adecuado. Valores de inicio de la velocidad de corte (m/min) y código alfabético. Las tablas con avances por diente y factores de corrección en la pag. 261.

P1.1 ■ 53 E	P1.2 ■ 59 E	P1.3 ■ 61 E	P2.1 ■ 45 E	P2.2 ■ 40 E	P3.1 ■ 36 E	P3.2 ■ 29 D	P4.1 ■ 22 D	M1.1 ■ 34 E	M1.2 ■ 29 E	M2.1 ■ 31 E	M2.2 ■ 25 D	K1.1 ■ 30 E	K1.2 ■ 22 E
K1.3 ■ 17 E	K2.1 ■ 55 E	K2.2 ■ 45 E	K2.3 ■ 36 D	K3.1 ■ 49 E	K3.2 ■ 37 E	K3.3 ■ 30 D	K4.1 ■ 45 D	K4.2 ■ 34 D	K4.3 ■ 25 D	K4.4 ■ 22 C	K4.5 ■ 18 C	K5.1 ■ 51 D	K5.2 ■ 39 D
K5.3 ■ 30 D	N1.1 ■ 95 G	N1.2 ■ 71 F	N1.3 ■ 48 F	N2.1 ■ 48 E	N2.2 ■ 43 E	N2.3 ■ 31 E	N3.1 ■ 50 E	N3.2 ■ 29 E	N3.3 ■ 15 E	N4.1 ■ 50 E	S1.1 ■ 30 D	S1.2 ■ 25 D	S2.1 ■ 20 C
S3.1 ■ 15 C	S4.1 ■ 12 C												

DCON MS tolerancia h6; RE ±0.05 mm.

Product	DC (mm)	RE (mm)	DCON MS (mm)	APMX (mm)	OAL (mm)	NOF	LU (mm)	DN (mm)
C5002.0	2.00	1.00	6.00	4.00	48.0	2	-	-
C5003.0	3.00	1.50	6.00	5.00	49.0	2	-	-
C5004.0	4.00	2.00	6.00	7.00	51.0	2	-	-
C5005.0	5.00	2.50	6.00	8.00	52.0	2	-	-
C5006.0	6.00	3.00	6.00	8.00	52.0	2	-	-
C5007.0	7.00	3.50	10.00	10.00	60.0	2	-	-
C5008.0	8.00	4.00	10.00	11.00	61.0	2	-	-
C50010.0	10.00	5.00	10.00	13.00	63.0	2	-	-
C50012.0	12.00	6.00	12.00	16.00	73.0	2	-	-
C50014.0	14.00	7.00	12.00	16.00	73.0	2	27.50	11.50
C50015.0	15.00	7.50	12.00	16.00	73.0	2	27.50	11.50
C50016.0	16.00	8.00	16.00	19.00	79.0	2	30.50	15.50
C50018.0	18.00	9.00	16.00	19.00	79.0	2	30.50	15.50
C50020.0	20.00	10.00	20.00	22.00	88.0	2	37.50	19.50

C505



Fresa HSS-E de 2 Filos con Punta Esférica, Acabado Brillante

Fresa con longitud de corte corta de 2 filos, que proporciona alta rigidez para aumentar la resistencia y reducir vibraciones. Geometría diseñada para contorneado de superficies complejas en máquinas CNC. Adecuada para aceros suaves, materiales no féreos y aleaciones de titanio de resistencia media. Cuello reducido a partir de diámetro 14 mm.

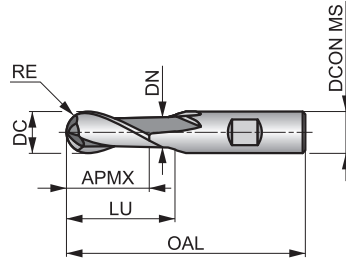

HSS-E	N	NOF 2
	λ 30°	γ 12°
DIN 1835B	Bright	DC e8
	DIN 844K	



Grupo de Material de la pieza adecuado. Valores de inicio de la velocidad de corte (m/min) y código alfabético. Las tablas con avances por diente y factores de corrección en la pag. 261.

P1.1 ■ 46 D	P1.2 ■ 52 D	P1.3 ■ 54 D	P2.1 ■ 40 D	P2.2 ■ 35 D	P3.1 ■ 32 D	P3.2 ■ 26 C	P4.1 ■ 19 C	M1.1 ■ 34 D	M1.2 ■ 29 D	M2.1 ■ 31 D	M2.2 ■ 25 C	K1.1 ■ 30 D	K1.2 ■ 22 D
K1.3 ■ 17 D	K2.1 ■ 49 D	K2.2 ■ 40 D	K2.3 ■ 32 C	K3.1 ■ 44 D	K3.2 ■ 33 D	K3.3 ■ 27 B	K4.1 ■ 40 C	K4.2 ■ 30 C	K4.3 ■ 22 C	K4.4 ■ 19 B	K4.5 ■ 16 B	K5.1 ■ 46 C	K5.2 ■ 34 C
K5.3 ■ 27 C	N1.1 ■ 81 F	N1.2 ■ 60 E	N1.3 ■ 41 E	N2.1 ■ 41 D	N2.2 ■ 37 D	N2.3 ■ 26 D	N3.1 ■ 43 D	N3.2 ■ 25 D	N3.3 ■ 13 D	N4.1 ■ 43 D	S1.1 ■ 30 C	S1.2 ■ 25 C	S2.1 ■ 20 B
S3.1 ■ 15 B	S4.1 ■ 12 B												

DCON MS tolerancia h6; RE ±0.05 mm.

Product	DC (mm)	RE (mm)	DCON MS (mm)	APMX (mm)	OAL (mm)	NOF	LU (mm)	DN (mm)
C5053.0	3.00	1.50	6.00	8.00	52.0	2	-	-
C5054.0	4.00	2.00	6.00	11.00	55.0	2	-	-
C5055.0	5.00	2.50	6.00	13.00	57.0	2	-	-
C5056.0	6.00	3.00	6.00	13.00	57.0	2	-	-
C5058.0	8.00	4.00	10.00	19.00	69.0	2	-	-
C50510.0	10.00	5.00	10.00	22.00	72.0	2	-	-
C50512.0	12.00	6.00	12.00	26.00	83.0	2	-	-
C50514.0	14.00	7.00	12.00	26.00	83.0	2	37.50	11.50
C50516.0	16.00	8.00	16.00	32.00	92.0	2	43.50	15.50
C50520.0	20.00	10.00	20.00	38.00	104.0	2	53.50	19.50
C50522.0	22.00	11.00	20.00	38.00	104.0	2	53.50	19.50
C50530.0	30.00	15.00	25.00	45.00	121.0	2	64.50	24.50

Código de Material (BMC)	HSS-E	HSS-E	HSS-E	HSS-E						
Perfil de la fresa	N	N	N	N						
Número de canales (NOF)	NOF 4-5	NOF 10-12	NOF 6-8	NOF 6-12						
Longitud de corte										
Ángulo de hélice (FHA)	λ 0°	λ 0°	λ 15°	λ 10°						
Ángulo de hélice (FHA)	λ 0°	λ 0°	λ 15°	λ 10°						
Ángulo de incidencia radial (GAMF)	γ 0°	γ 0°	γ 10°	γ 10°						
Mango										
Recubrimiento	Bright	Bright	Bright	Bright						
Clase de tolerancia del diámetro de corte (TCDC)		DC js16	DC d11	DC h11						
Dirección										
Grupo básico estándar (BSG)		DIN 1833C	DIN 851	DIN 850						

Código de Familia de Producto		C700	C830	C800	C822					
Gama de diámetros de corte PSF		1.00 – 15.00	12.00 – 32.00	11.00 – 32.00	4.50 – 45.50					
P	P1	■	■	■	■					
	P2	■	■	■	■					
	P3	■	■	■	■					
	P4	■	■	■	■					
M	M1	■	■	■	■					
	M2	■	■	■	■					
	M3	■	■	■	■					
	M4	■	■	■	■					
K	K1	■	■	■	■					
	K2	■	■	■	■					
	K3	■	■	■	■					
	K4	■	■	■	■					
	K5	■	■	■	■					
N	N1	■	■	■	■					
	N2	■	■	■	■					
	N3	■	■	■	■					
	N4		■	■	■					
	N5			■	■					
S	S1	■	■	■	■					
	S2	■	■	■	■					
	S3	■	■	■	■					
	S4	■	■	■	■					
H	H1									
	H2									
	H3									
	H4									

C700



Fresa HSS-E para Redondeado de Esquinas

Fresa con un radio rectificado de precisión, adecuada para producir un radio de esquina en todo el perímetro de un componente. El mango Weldon proporciona un amarre seguro y estable y mejora el acabado superficial del radio mecanizado. Acabado brillante.

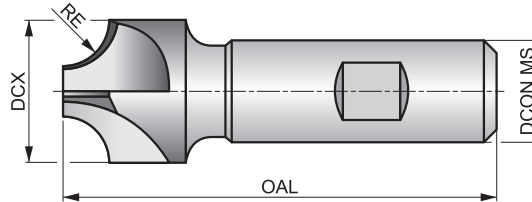

HSS-E	N	NOF 4-5
	λ 0°	γ 0°
DIN 1835B	Bright	
DORMER		



Grupo de Material de la pieza adecuado. Valores de inicio de la velocidad de corte (m/min) y código alfabético. Las tablas con avances por diente y factores de corrección en la pag. 261.

P1.1 ■ 33 W	P1.2 ■ 37 W	P1.3 ■ 38 W	P2.1 ■ 28 W	P2.2 ■ 25 W	P2.3 ■ 22 W	P3.1 ■ 22 W	P3.2 ■ 18 W	P3.3 ■ 15 W	P4.1 ■ 13 W	P4.2 ■ 11 W	P4.3 ■ 9 W	M1.1 ■ 27 U	M1.2 ■ 23 U
M2.1 ■ 24 U	M2.2 ■ 20 U	M3.1 ■ 17 U	M3.2 ■ 15 U	M3.3 ■ 14 U	M4.1 ■ 10 U	K1.1 ■ 20 W	K1.2 ■ 15 W	K1.3 ■ 11 W	K2.1 ■ 31 W	K2.2 ■ 25 W	K2.3 ■ 20 W	K3.1 ■ 27 W	K3.2 ■ 21 W
K3.3 ■ 17 W	K4.1 ■ 25 U	K4.2 ■ 19 U	K4.3 ■ 14 U	K4.4 ■ 12 U	K4.5 ■ 10 U	K5.1 ■ 29 W	K5.2 ■ 21 W	K5.3 ■ 17 W	N1.1 ■ 57 X	N1.2 ■ 43 X	N1.3 ■ 29 X	N2.1 ■ 29 X	N2.2 ■ 26 X
N2.3 ■ 19 X	N3.1 ■ 30 X	N3.2 ■ 17 X	N3.3 ■ 9 X	S1.1 ■ 25 U	S1.2 ■ 20 U	S1.3 ■ 10 U	S2.1 ■ 13 U	S2.2 ■ 7 U	S3.1 ■ 10 U	S3.2 ■ 5 U	S4.1 ■ 8 U	S4.2 ■ 4 U	

DCON MS tolerancia h6.

Product	RE (mm)	DCX (mm)	DCON MS (mm)	OAL (mm)	NOF
C7001.0	1.00	10.00	10.00	60.0	4
C7001.5	1.50	10.00	10.00	60.0	4
C7002.0	2.00	10.00	10.00	60.0	4
C7002.5	2.50	10.00	10.00	60.0	4
C7003.0	3.00	12.00	12.00	60.0	4
C7003.5	3.50	12.00	12.00	60.0	4
C7004.0	4.00	15.00	12.00	60.0	4
C7005.0	5.00	18.00	16.00	70.0	4
C7006.0	6.00	21.00	16.00	70.0	4
C7007.0	7.00	24.00	16.00	70.0	4
C7008.0	8.00	24.00	16.00	70.0	4
C7009.0	9.00	28.00	20.00	85.0	4
C70010.0	10.00	28.00	20.00	85.0	4
C70012.0	12.00	35.00	20.00	100.0	4
C70012.5	12.50	35.00	20.00	100.0	4
C70015.0	15.00	48.00	25.00	105.0	5

C830

DORMER



Fresa para Cola de Milano HSS-E

Diseñada con ángulo opcional de 45° y 60° y mango Weldon para un amarre preciso y estable. Adecuada para formas de cola de milano comunes. El acabado brillante evita que el material de la pieza se adhiera a los filos de corte de la herramienta.

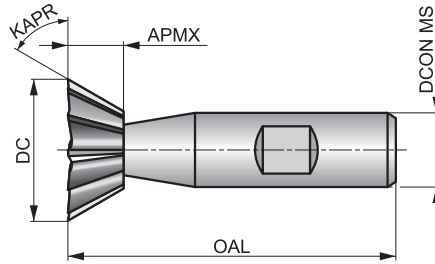

HSS-E	N	NOF 10-12
λ 0°	γ 0°	DIN 1835B
Bright	DC js16	
DIN 1833C		

Grupo de Material de la pieza adecuado. Valores de inicio de la velocidad de corte (m/min) y código alfabético. Las tablas con avances por diente y factores de corrección en la pag. 261.

P1.1 ■ 33 Y	P1.2 ■ 37 Y	P1.3 ■ 38 Y	P2.1 ■ 28 Y	P2.2 ■ 25 X	P2.3 ■ 22 X	P3.1 ■ 22 X	P3.2 ■ 18 X	P3.3 ■ 15 X	P4.1 ■ 13 X	P4.2 ■ 11 X	P4.3 ■ 9 X	M1.1 ■ 27 W	M1.2 ■ 23 W
M2.1 ■ 24 W	M2.2 ■ 20 W	M3.1 ■ 17 W	M3.2 ■ 15 W	M3.3 ■ 14 W	M4.1 ■ 10 W	K1.1 ■ 20 Y	K1.2 ■ 15 Y	K1.3 ■ 11 Y	K2.1 ■ 31 X	K2.2 ■ 25 X	K2.3 ■ 20 X	K3.1 ■ 27 X	K3.2 ■ 21 X
K3.3 ■ 17 X	K4.1 ■ 25 W	K4.2 ■ 19 W	K4.3 ■ 14 W	K4.4 ■ 12 W	K4.5 ■ 10 W	K5.1 ■ 29 X	K5.2 ■ 21 X	K5.3 ■ 17 X	N1.1 ■ 59 Z	N1.2 ■ 44 Z	N1.3 ■ 30 Z	N2.1 ■ 30 Z	N2.2 ■ 27 Z
N2.3 ■ 19 Z	N3.1 ■ 31 Y	N3.2 ■ 18 Y	N3.3 ■ 9 Z	N4.1 ■ 31 Z	S1.1 ■ 25 Y	S1.2 ■ 15 Y	S1.3 ■ 10 X	S2.1 ■ 13 W	S2.2 ■ 7 W	S3.1 ■ 10 W	S3.2 ■ 5 W	S4.1 ■ 8 W	S4.2 ■ 4 W

DCON MS tolerancia h6.

Product	KAPR (°)	APMX (mm)	DC (mm)	OAL (mm)	DCON MS (mm)	NOF
C83012.0X45	45	3.50	12.00	54.0	10.00	10
C83016.0X45	45	4.00	16.00	60.0	12.00	10
C83020.0X45	45	5.00	20.00	63.0	12.00	10
C83025.0X45	45	6.30	25.00	67.0	12.00	10
C83032.0X45	45	8.00	32.00	71.0	16.00	12
C83012.0X60	60	5.00	12.00	54.0	10.00	10
C83016.0X60	60	6.30	16.00	60.0	12.00	10
C83020.0X60	60	8.00	20.00	63.0	12.00	10
C83025.0X60	60	10.00	25.00	67.0	12.00	10
C83032.0X60	60	12.50	32.00	71.0	16.00	12

C800

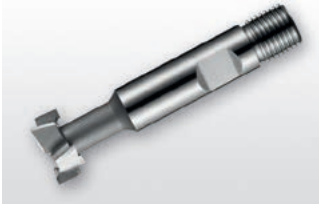

Fresa HSS-E para Ranuras en T

Adecuada para fresado de ranuras en T. Para un amarre preciso y estable en todo tipo de portaherramientas tiene un mango combinado, capaz de fresar ranuras en T para alojar tornillos estándar con cabeza en T. El acabado brillante evita que el material de la pieza se adhiera al filo de corte.

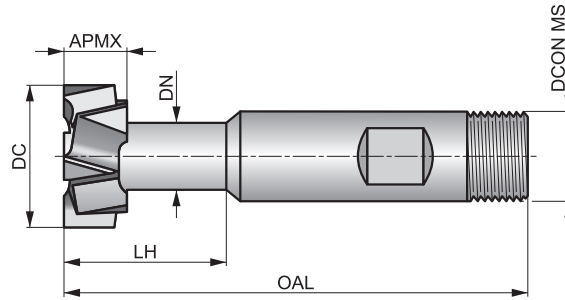

HSS-E	N	NOF 6-8
λ 15°	γ 10°	DIN 1835
Bright	DC d11	
DIN 851		



Grupo de Material de la pieza adecuado. Valores de inicio de la velocidad de corte (m/min) y código alfabético. Las tablas con avances por diente y factores de corrección en la pag. 261.

P1.1 ■ 40V	P1.2 ■ 45V	P1.3 ■ 46V	P2.1 ■ 34V	P2.2 ■ 30U	P2.3 ■ 27T	P3.1 ■ 29U	P3.2 ■ 24U	P3.3 ■ 20T	P4.1 ■ 18U	P4.2 ■ 15T	P4.3 ■ 12T	M1.1 ■ 27S	M1.2 ■ 23S
M2.1 ■ 24S	M2.2 ■ 20S	M3.1 ■ 17S	M3.2 ■ 15S	M3.3 ■ 14S	M4.1 ■ 10S	K1.1 ■ 20V	K1.2 ■ 15V	K1.3 ■ 11V	K2.1 ■ 37U	K2.2 ■ 30U	K2.3 ■ 24U	K3.1 ■ 33U	K3.2 ■ 25U
K3.3 ■ 20U	K4.1 ■ 30S	K4.2 ■ 23S	K4.3 ■ 17S	K4.4 ■ 14S	K4.5 ■ 12S	K5.1 ■ 34U	K5.2 ■ 26U	K5.3 ■ 20U	N1.1 ■ 71Y	N1.2 ■ 53Y	N1.3 ■ 36Y	N2.1 ■ 36Y	N2.2 ■ 32Y
N2.3 ■ 23Y	N3.1 ■ 38V	N3.2 ■ 22V	N3.3 ■ 11W	N4.1 ■ 38Y	S1.1 ■ 30V	S1.2 ■ 20V	S1.3 ■ 10U	S2.1 ■ 13U	S2.2 ■ 7T	S3.1 ■ 10U	S3.2 ■ 5T	S4.1 ■ 8U	S4.2 ■ 4T

DCON MS tolerancia h6.

Product	APMX (mm)	DC (mm)	T DIN650	DN (mm)	LH (mm)	OAL (mm)	DCON MS (mm)	NOF
C80011.0X5.0	4.00	11.00	5	4.00	10.5	53.5	10.00	6
C80012.5X6.0	6.00	12.50	6	5.00	15.0	57.0	10.00	6
C80016.0X8.0	8.00	16.00	8	7.00	20.0	62.0	10.00	6
C80018.0X10.0	8.00	18.00	10	8.00	23.0	70.0	12.00	6
C80021.0X12.0	9.00	21.00	12	10.00	27.0	74.0	12.00	8
C80025.0X14.0	11.00	25.00	14	12.00	31.0	82.0	16.00	8
C80032.0X18.0	14.00	32.00	18	15.00	40.0	90.0	16.00	8

C822



Fresa HSS-E para Ranuras Woodruff

Adecuada para fresado de chaveteros Woodruff en husillos y ejes. El mango combinado proporciona un amarre preciso y estable en todo tipo de portaherramientas. El acabado brillante evita que el material se adhiera al filo de corte.

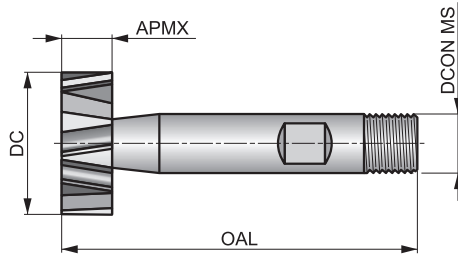

HSS-E	N	NOF 6-12
λ 10°	γ 10°	DIN 1835
Bright	DC h11	
DIN 850		

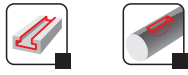

Grupo de Material de la pieza adecuado. Valores de inicio de la velocidad de corte (m/min) y código alfabético. Las tablas con avances por diente y factores de corrección en la pag. 261.

P1.1 ■ 40V	P1.2 ■ 45V	P1.3 ■ 46V	P2.1 ■ 34V	P2.2 ■ 30U	P2.3 ■ 27T	P3.1 ■ 29U	P3.2 ■ 24U	P3.3 ■ 20T	P4.1 ■ 18U	P4.2 ■ 15T	P4.3 ■ 12T	M1.1 ■ 34S	M1.2 ■ 29S
M2.1 ■ 31S	M2.2 ■ 25S	M3.1 ■ 17S	M3.2 ■ 15S	M3.3 ■ 14S	M4.1 ■ 15S	K1.1 ■ 25V	K1.2 ■ 19V	K1.3 ■ 14V	K2.1 ■ 37U	K2.2 ■ 30U	K2.3 ■ 24U	K3.1 ■ 33U	K3.2 ■ 25U
K3.3 ■ 20U	K4.1 ■ 30S	K4.2 ■ 23S	K4.3 ■ 17S	K4.4 ■ 14S	K4.5 ■ 12S	K5.1 ■ 34U	K5.2 ■ 26U	K5.3 ■ 20U	N1.1 ■ 71Y	N1.2 ■ 53Y	N1.3 ■ 36Y	N2.1 ■ 36Y	N2.2 ■ 32Y
N2.3 ■ 23Y	N3.1 ■ 38V	N3.2 ■ 22V	N3.3 ■ 11W	N4.1 ■ 38Y	S1.1 ■ 30V	S1.2 ■ 20V	S1.3 ■ 10U	S2.1 ■ 13U	S2.2 ■ 7T	S3.1 ■ 10U	S3.2 ■ 5T	S4.1 ■ 8U	S4.2 ■ 4T

DCON MS tolerancia h6.

Product	APMX (mm)	DC (mm)	OAL (mm)	DCON MS (mm)	NOF
C8224.5X1.0	1.00	4.50	50.0	6.00	6
C8227.5X1.5	1.50	7.50	50.0	6.00	6
C8227.5X2.0	2.00	7.50	50.0	6.00	6
C82210.5X2.0	2.00	10.50	50.0	6.00	8
C82210.5X2.5	2.50	10.50	50.0	6.00	8
C82210.5X3.0	3.00	10.50	50.0	6.00	8
C82213.5X3.0	3.00	13.50	56.0	10.00	8
C82213.5X4.0	4.00	13.50	56.0	10.00	8
C82216.5X3.0	3.00	16.50	56.0	10.00	8
C82216.5X4.0	4.00	16.50	56.0	10.00	8
C82216.5X5.0	5.00	16.50	56.0	10.00	8
C82219.5X3.0	3.00	19.50	63.0	10.00	10
C82219.5X4.0	4.00	19.50	63.0	10.00	10
C82219.5X5.0	5.00	19.50	63.0	10.00	10
C82222.5X5.0	5.00	22.50	63.0	10.00	10
C82222.5X6.0	6.00	22.50	63.0	10.00	10
C82222.5X8.0	8.00	22.50	63.0	10.00	10
C82225.5X6.0	6.00	25.50	63.0	10.00	12
C82228.5X6.0	6.00	28.50	63.0	10.00	12
C82228.5X8.0	8.00	28.50	63.0	10.00	12
C82228.5X10.0	10.00	28.50	71.0	12.00	12
C82232.5X8.0	8.00	32.50	71.0	12.00	12
C82232.5X10.0	10.00	32.50	71.0	12.00	12
C82245.5X10.0	10.00	45.50	71.0	12.00	12

Código de Material (BMC)	HSS	HSS	HSS	HSS	HSS	HSS
Perfil de la fresa						
Número de canales (NOF)						
Ángulo de hélice (FHA)						
Ángulo de hélice (FHA)						
Ángulo de incidencia radial (GAMF)	γ 15°	γ 5°	γ 18°	γ 18°	γ 18°	γ 18°
Recubrimiento	Bright	Bright	ST	ST	ST	ST
Clase de tolerancia del diámetro de corte (TCDC)						
Dirección						
Grupo básico estándar (BSG)	DIN 1838	DIN 1837	DORMER	DORMER	DORMER	DORMER
Código de Familia de Producto	D745	D747	D750	D751	D752	D753
Gama de diámetros de corte PSF	50.00 – 250.00	32.00 – 200.00	200.00 – 350.00	200.00 – 350.00	250.00 – 350.00	250.00 – 350.00
	56	58	60	61	62	63
P	P1	■	■	■	■	■
	P2	■	■	■	■	■
	P3	■	■	■	■	■
	P4	■	■	■	■	■
M	M1	▣	▣	▣	▣	▣
	M2	▣	▣	▣	▣	▣
	M3	▣	▣	▣	▣	▣
	M4					
K	K1	■	■	■	■	■
	K2	■	■	■	■	■
	K3	■	■	■	■	■
	K4	■	■	■	■	■
	K5	■	■	■	■	■
N	N1	■	■	■	■	■
	N2	■	■	■	■	■
	N3	■	■	■	■	■
	N4	■	■	■	■	■
	N5					
S	S1					
	S2					
	S3					
	S4					
H	H1					
	H2					
	H3					
	H4					

HSS-E	HSS-E	HSS-E	HSS-E
	N	N	NR
λ 15°	λ 30°	λ 30°	λ 30°
λ 15°	λ 30°	λ 30°	λ 30°
γ 10°	γ 12°	γ 12°	γ 12°
Bright	Bright	TiCN	Bright
DC js16	DC js16	DC js16	DC js16



D763	D400	D420	D402
------	------	------	------

63.00 – 125.00	40.00 – 50.00	63.00	63.00
----------------	---------------	-------	-------

64	65	66	67
----	----	----	----

P1	■	■	■	■
P2	■	■	■	■
P3	■	■	■	■
P4	■	▣	■	▣
M1	■	■	■	■
M2	■	■	■	■
M3	■	▣	■	▣
M4	■	■	■	■
K1	■	■	■	■
K2	■	■	■	■
K3	■	■	■	■
K4	■	■	■	■
K5	■	■	■	■
N1	■	▣	▣	▣
N2	■	■	■	■
N3	■	■	■	■
N4	■	▣	▣	▣
N5	■	■	■	■
S1	■	▣	■	▣
S2	■	▣	■	▣
S3	■	▣	■	▣
S4	■	▣	■	▣
H1				
H2				
H3				
H4				

D745

DORMER



Sierra circular HSS de paso grande

Diseñada con paso grande ideal para ranuras estrechas y profundas, la geometría neutra de los dientes ayudan a controlar la viruta y previenen el roce al fresar ranuras profundas. Adecuada para fresado horizontal de ranuras y aplicaciones de tronzado. Acabado brillante.

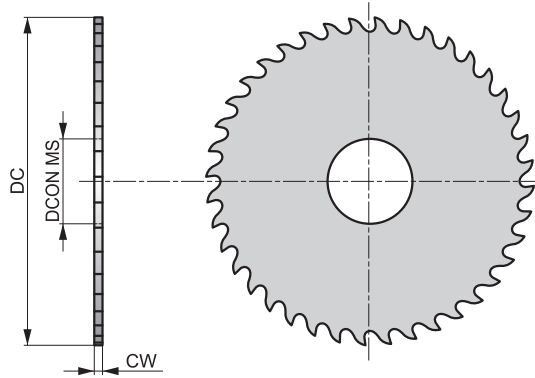

HSS		γ 15°
Bright	DIN 1838	



Grupo de Material de la pieza adecuado. Valores de inicio de la velocidad de corte (m/min) y código alfabético. Las tablas con avances por diente y factores de corrección en la pag. 261.

P1.1 ■ 40 Q	P1.2 ■ 45 Q	P1.3 ■ 46 Q	P2.1 ■ 34 Q	P2.2 ■ 30 Q	P3.1 ■ 29 P	P3.2 ■ 24 P	P4.1 ■ 18 P	M1.1 ▣ 14 P	M1.2 ▣ 12 P	M2.1 ▣ 12 P	M2.2 ▣ 10 P	M3.1 ▣ 12 P	M3.2 ▣ 10 P
K1.1 ■ 40 Q	K1.2 ■ 30 Q	K1.3 ■ 22 Q	K2.1 ■ 37 Q	K2.2 ■ 30 Q	K3.1 ■ 33 Q	K3.2 ■ 25 Q	K4.1 ■ 30 P	K4.2 ■ 23 P	K5.1 ■ 34 Q	K5.2 ■ 26 Q	N1.1 ■ 600 R	N1.2 ■ 450 R	N1.3 ■ 300 R
N2.1 ■ 769 R	N2.2 ■ 692 R	N2.3 ■ 500 R	N3.1 ■ 339 R	N3.2 ■ 200 R	N3.3 ■ 100 Q	N4.1 ■ 60 R							

Product	DC	CW	DCON MS	NOF
	(mm)	(mm)	(mm)	
D74550.0X.5	50.00	0.5	13.00	48
D74550.0X.8	50.00	0.8	13.00	40
D74550.0X1.0	50.00	1.0	13.00	40
D74550.0X1.2	50.00	1.2	13.00	40
D74550.0X1.5	50.00	1.5	13.00	32
D74550.0X1.6	50.00	1.6	13.00	32
D74550.0X2.0	50.00	2.0	13.00	32
D74563.0X.5	63.00	0.5	16.00	64
D74563.0X.6	63.00	0.6	16.00	48
D74563.0X.8	63.00	0.8	16.00	48
D74563.0X1.0	63.00	1.0	16.00	48
D74563.0X1.2	63.00	1.2	16.00	40
D74563.0X1.5	63.00	1.5	16.00	40
D74563.0X1.6	63.00	1.6	16.00	40
D74563.0X2.0	63.00	2.0	16.00	40
D74580.0X1.0	80.00	1.0	22.00	48
D74580.0X1.2	80.00	1.2	22.00	48
D74580.0X1.5	80.00	1.5	22.00	48
D74580.0X1.6	80.00	1.6	22.00	48
D74580.0X2.0	80.00	2.0	22.00	40
D74580.0X2.5	80.00	2.5	22.00	40
D74580.0X3.0	80.00	3.0	22.00	40
D745100.0X1.0	100.00	1.0	22.00	64
D745100.0X1.2	100.00	1.2	22.00	64
D745100.0X1.5	100.00	1.5	22.00	48
D745100.0X1.6	100.00	1.6	22.00	48
D745100.0X2.0	100.00	2.0	22.00	48
D745100.0X2.5	100.00	2.5	22.00	48

Product	DC	CW	DCON MS	NOF
	(mm)	(mm)	(mm)	
D745100.0X3.0	100.00	3.0	22.00	40
D745100.0X4.0	100.00	4.0	22.00	40
D745125.0X1.0	125.00	1.0	22.00	80
D745125.0X1.2	125.00	1.2	22.00	64
D745125.0X1.5	125.00	1.5	22.00	64
D745125.0X1.6	125.00	1.6	22.00	64
D745125.0X2.0	125.00	2.0	22.00	64
D745125.0X2.5	125.00	2.5	22.00	48
D745125.0X3.0	125.00	3.0	22.00	48
D745160.0X2.0	160.00	2.0	32.00	64
D745160.0X2.5	160.00	2.5	32.00	64
D745160.0X3.0	160.00	3.0	32.00	64
D745200.0X1.6	200.00	1.6	32.00	80
D745200.0X2.0	200.00	2.0	32.00	80
D745200.0X2.5	200.00	2.5	32.00	80
D745200.0X3.0	200.00	3.0	32.00	64
D745250.0X2.0	250.00	2.0	32.00	100

D747



Sierra circular HSS de paso fino

Diseñada con geometría neutra de los dientes para ayudar a controlar la viruta y evitar roces al fresar ranuras profundas. El paso fino la hace ideal para ranuras estrechas y profundas y se puede utilizar para fresado horizontal de ranuras y aplicaciones de tronzado. Acabado brillante.

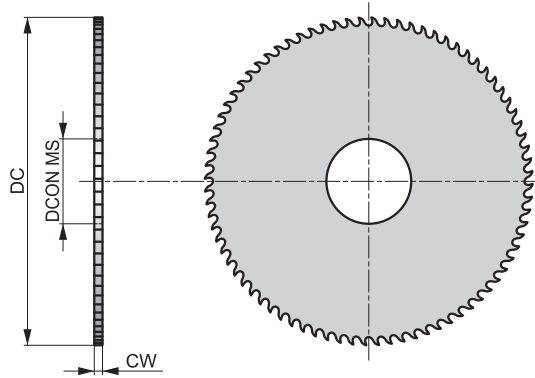

HSS		γ 5°
Bright	DIN 1837	



Grupo de Material de la pieza adecuado. Valores de inicio de la velocidad de corte (m/min) y código alfabético. Las tablas con avances por diente y factores de corrección en la pag. 261.

P1.1 ■ 40 Q	P1.2 ■ 45 Q	P1.3 ■ 46 Q	P2.1 ■ 34 Q	P2.2 ■ 30 Q	P3.1 ■ 29 P	P3.2 ■ 24 P	P4.1 ■ 18 P	M1.1 ▣ 14 P	M1.2 ▣ 12 P	M2.1 ▣ 12 P	M2.2 ▣ 10 P	M3.1 ▣ 12 P	M3.2 ▣ 10 P
K1.1 ■ 40 Q	K1.2 ■ 30 Q	K1.3 ■ 22 Q	K2.1 ■ 37 Q	K2.2 ■ 30 Q	K3.1 ■ 33 Q	K3.2 ■ 25 Q	K4.1 ■ 30 P	K4.2 ■ 23 P	K5.1 ■ 34 Q	K5.2 ■ 26 Q	N1.1 ■ 600 R	N1.2 ■ 450 R	N1.3 ■ 300 R
N2.1 ■ 769 R	N2.2 ■ 692 R	N2.3 ■ 500 R	N3.1 ■ 339 R	N3.2 ■ 200 R	N3.3 ■ 100 Q	N4.1 ■ 60 R							

Product	DC	CW	DCON MS	NOF
	(mm)	(mm)	(mm)	
D74732.0X.3	32.00	0.3	8.00	80
D74732.0X.4	32.00	0.4	8.00	80
D74732.0X.5	32.00	0.5	8.00	80
D74732.0X.6	32.00	0.6	8.00	64
D74732.0X.8	32.00	0.8	8.00	64
D74732.0X1.0	32.00	1.0	8.00	64
D74732.0X1.2	32.00	1.2	8.00	48
D74732.0X1.5	32.00	1.5	8.00	48
D74732.0X1.6	32.00	1.6	8.00	48
D74732.0X2.0	32.00	2.0	8.00	48
D74740.0X.3	40.00	0.3	10.00	100
D74740.0X.4	40.00	0.4	10.00	100
D74740.0X.5	40.00	0.5	10.00	80
D74740.0X.8	40.00	0.8	10.00	80
D74740.0X1.0	40.00	1.0	10.00	64
D74740.0X1.2	40.00	1.2	10.00	64
D74740.0X1.5	40.00	1.5	10.00	64
D74740.0X1.6	40.00	1.6	10.00	64
D74740.0X2.0	40.00	2.0	10.00	48
D74750.0X.3	50.00	0.3	13.00	128
D74750.0X.4	50.00	0.4	13.00	100
D74750.0X.5	50.00	0.5	13.00	100
D74750.0X.6	50.00	0.6	13.00	100
D74750.0X.8	50.00	0.8	13.00	80
D74750.0X1.0	50.00	1.0	13.00	80
D74750.0X1.2	50.00	1.2	13.00	80
D74750.0X1.5	50.00	1.5	13.00	64
D74750.0X1.6	50.00	1.6	13.00	64



Product	DC	CW	DCON MS	NOF
	(mm)	(mm)	(mm)	
D74750.0X2.0	50.00	2.0	13.00	64
D74750.0X2.5	50.00	2.5	13.00	64
D74750.0X3.0	50.00	3.0	13.00	48
D74763.0X.5	63.00	0.5	16.00	128
D74763.0X.6	63.00	0.6	16.00	100
D74763.0X.8	63.00	0.8	16.00	100
D74763.0X1.0	63.00	1.0	16.00	100
D74763.0X1.2	63.00	1.2	16.00	80
D74763.0X1.5	63.00	1.5	16.00	80
D74763.0X1.6	63.00	1.6	16.00	80
D74763.0X2.0	63.00	2.0	16.00	80
D74763.0X2.5	63.00	2.5	16.00	64
D74763.0X3.0	63.00	3.0	16.00	64
D74763.0X4.0	63.00	4.0	16.00	64
D74780.0X.5	80.00	0.5	22.00	128
D74780.0X.6	80.00	0.6	22.00	128
D74780.0X.8	80.00	0.8	22.00	128
D74780.0X1.0	80.00	1.0	22.00	100
D74780.0X1.2	80.00	1.2	22.00	100
D74780.0X1.5	80.00	1.5	22.00	100
D74780.0X1.6	80.00	1.6	22.00	100
D74780.0X2.0	80.00	2.0	22.00	80
D74780.0X2.5	80.00	2.5	22.00	80
D74780.0X3.0	80.00	3.0	22.00	80
D74780.0X4.0	80.00	4.0	22.00	64
D747100.0X.5	100.00	0.5	22.00	160
D747100.0X.6	100.00	0.6	22.00	160
D747100.0X.8	100.00	0.8	22.00	128
D747100.0X1.0	100.00	1.0	22.00	128
D747100.0X1.2	100.00	1.2	22.00	128
D747100.0X1.5	100.00	1.5	22.00	100
D747100.0X1.6	100.00	1.6	22.00	100
D747100.0X2.0	100.00	2.0	22.00	100
D747100.0X2.5	100.00	2.5	22.00	100
D747100.0X3.0	100.00	3.0	22.00	80
D747100.0X4.0	100.00	4.0	22.00	80
D747125.0X1.0	125.00	1.0	22.00	160
D747125.0X1.2	125.00	1.2	22.00	128
D747125.0X1.5	125.00	1.5	22.00	128
D747125.0X1.6	125.00	1.6	22.00	128
D747125.0X2.0	125.00	2.0	22.00	128
D747125.0X2.5	125.00	2.5	22.00	100
D747125.0X3.0	125.00	3.0	22.00	100
D747125.0X4.0	125.00	4.0	22.00	100
D747160.0X1.0	160.00	1.0	32.00	160
D747160.0X1.2	160.00	1.2	32.00	160
D747160.0X1.5	160.00	1.5	32.00	160
D747160.0X2.0	160.00	2.0	32.00	128
D747160.0X2.5	160.00	2.5	32.00	128
D747160.0X3.0	160.00	3.0	32.00	128
D747200.0X1.0	200.00	1.0	32.00	200
D747200.0X1.2	200.00	1.2	32.00	200
D747200.0X2.0	200.00	2.0	32.00	160
D747200.0X3.0	200.00	3.0	32.00	128

D750

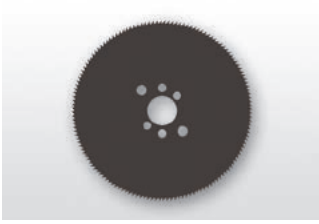

Sierra circular HSS de paso fino

Diseñada con paso grande, ideal para componentes de sección delgada. Adecuada para ranurar y cortar. Número de dientes desde 130 hasta 220. La geometría neutra de los dientes, además de ayudar a controlar la viruta, también previenen el roce al cortar tubos y tuberías. El acabado de óxido al vapor actúa para retener el fluido de corte y evitar la soldadura de la viruta en la herramienta.

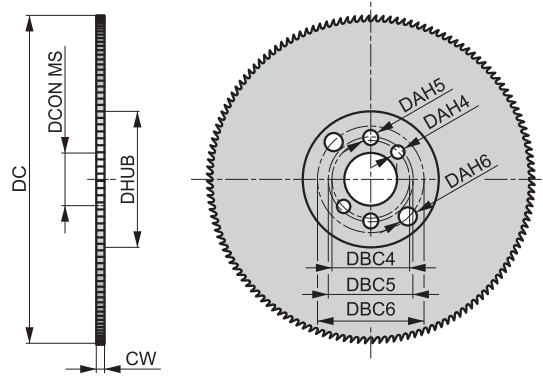

HSS
 γ 18°



Grupo de Material de la pieza adecuado. Valores de inicio de la velocidad de corte (m/min) y código alfabético. Las tablas con avances por diente y factores de corrección en la pag. 261.

P1.1 ■ 40 Q	P1.2 ■ 45 Q	P1.3 ■ 46 Q	P2.1 ■ 34 Q	P2.2 ■ 30 Q	P3.1 ■ 29 P	P3.2 ■ 24 P	P4.1 ■ 18 P	M1.1 ▣ 14 P	M1.2 ▣ 12 P	M2.1 ▣ 12 P	M2.2 ▣ 10 P	M3.1 ▣ 12 P	M3.2 ▣ 10 P
K1.1 ■ 40 Q	K1.2 ■ 30 Q	K1.3 ■ 22 Q	K2.1 ■ 37 Q	K2.2 ■ 30 Q	K3.1 ■ 33 Q	K3.2 ■ 25 Q	K4.1 ■ 30 P	K4.2 ■ 23 P	K5.1 ■ 34 Q	K5.2 ■ 26 Q	N1.1 ■ 600 R	N1.2 ■ 450 R	N1.3 ■ 300 R
N2.1 ■ 769 R	N2.2 ■ 692 R	N2.3 ■ 500 R	N3.1 ■ 339 R	N3.2 ■ 200 R	N3.3 ■ 100 Q	N4.1 ■ 60 R							

Product	DC (mm)	CW (mm)	DCON MS (mm)	NOF	P (mm)	DHUB (mm)	DAH4 (mm)	DBC4 (mm)	DAH5 (mm)	DBC5 (mm)	DAH6 (mm)	DBC6 (mm)
D750200.0X1.8	200.00	1.8	32.00	130	5	100	8	45	9	50	11	63
D750225.0X2.0	225.00	2.0	32.00	140	5	100	8	45	9	50	11	63
D750250.0X2.0	250.00	2.0	32.00	160	5	100	8	45	9	50	11	63
D750275.0X2.5	275.00	2.5	32.00	180	5	100	8	45	9	50	11	63
D750300.0X2.5	300.00	2.5	32.00	180	5	100	8	45	9	50	11	63
D750315.0X2.5	315.00	2.5	32.00	200	5	100	8	45	9	50	11	63
D750350.0X2.5	350.00	2.5	32.00	220	5	120	8	45	9	59	11	63

D751



Sierra circular HSS de paso fino

Diseñada con paso grande, ideal para componentes de sección delgada. Adecuada para ranurar y cortar. Número de dientes desde 160 hasta 350. La geometría neutra de los dientes, además de ayudar a controlar la viruta, también previenen el roce al cortar tubos y tuberías. El acabado de óxido al vapor actúa para retener el fluido de corte y evitar la soldadura de la viruta en la herramienta.

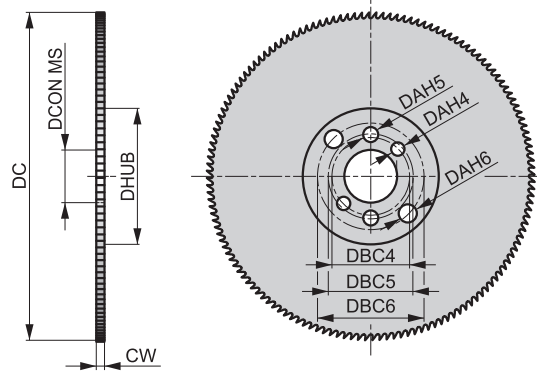

HSS
 γ 18°



Grupo de Material de la pieza adecuado. Valores de inicio de la velocidad de corte (m/min) y código alfabético. Las tablas con avances por diente y factores de corrección en la pag. 261.

P1.1 ■ 40 Q	P1.2 ■ 45 Q	P1.3 ■ 46 Q	P2.1 ■ 34 Q	P2.2 ■ 30 Q	P3.1 ■ 29 P	P3.2 ■ 24 P	P4.1 ■ 18 P	M1.1 ▣ 14 P	M1.2 ▣ 12 P	M2.1 ▣ 12 P	M2.2 ▣ 10 P	M3.1 ▣ 12 P	M3.2 ▣ 10 P
K1.1 ■ 40 Q	K1.2 ■ 30 Q	K1.3 ■ 22 Q	K2.1 ■ 37 Q	K2.2 ■ 30 Q	K3.1 ■ 33 Q	K3.2 ■ 25 Q	K4.1 ■ 30 P	K4.2 ■ 23 P	K5.1 ■ 34 Q	K5.2 ■ 26 Q	N1.1 ■ 600 R	N1.2 ■ 450 R	N1.3 ■ 300 R
N2.1 ■ 769 R	N2.2 ■ 692 R	N2.3 ■ 500 R	N3.1 ■ 339 R	N3.2 ■ 200 R	N3.3 ■ 100 Q	N4.1 ■ 60 R							

Product	DC (mm)	CW (mm)	DCON MS (mm)	NOF	P (mm)	DHUB (mm)	DAH4 (mm)	DBC4 (mm)	DAH5 (mm)	DBC5 (mm)	DAH6 (mm)	DBC6 (mm)
D751200.0X1.8X160	200.00	1.8	32.00	160	4	100	8	45	9	50	11	63
D751200.0X1.8X200	200.00	1.8	32.00	200	3	100	8	45	9	50	11	63
D751225.0X2.0X180	225.00	2.0	32.00	180	4	100	8	45	9	50	11	63
D751225.0X2.0X220	225.00	2.0	32.00	220	3	100	8	45	9	50	11	63
D751250.0X2.0X200	250.00	2.0	32.00	200	4	100	8	45	9	50	11	63
D751250.0X2.0X250	250.00	2.0	32.00	250	3	100	8	45	9	50	11	63
D751275.0X2.5X220	275.00	2.5	32.00	220	4	100	8	45	9	50	11	63
D751300.0X2.5X220	300.00	2.5	32.00	220	4	100	8	45	9	50	11	63
D751300.0X2.5X300	300.00	2.5	32.00	300	3	100	8	45	9	50	11	63
D751315.0X2.5X240	315.00	2.5	32.00	240	4	100	8	45	9	50	11	63
D751350.0X2.5X280	350.00	2.5	32.00	280	4	120	8	45	9	50	11	63
D751350.0X2.5X350	350.00	2.5	32.00	350	3	120	8	45	9	50	11	63

D752

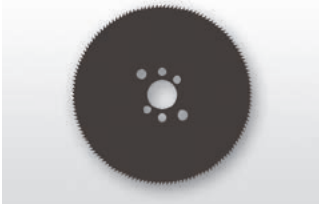

Sierra circular HSS de paso grande

Diseñada con paso grande, ideal para componentes de sección delgada. El rectificado y la geometría neutra de los dientes, además de ayudar a controlar la viruta, también previenen el roce al cortar tubos y tuberías. Adecuada para ranurar y cortar. El acabado de óxido al vapor actúa para retener el fluido de corte y evitar la soldadura de la viruta en la herramienta.

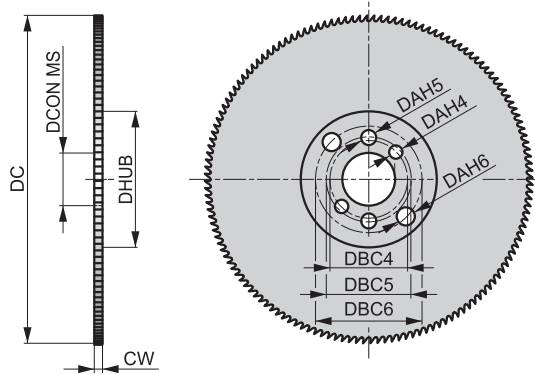

HSS		γ 18°



Grupo de Material de la pieza adecuado. Valores de inicio de la velocidad de corte (m/min) y código alfabético. Las tablas con avances por diente y factores de corrección en la pag. 261.

P1.1 ■ 40 Q	P1.2 ■ 45 Q	P1.3 ■ 46 Q	P2.1 ■ 34 Q	P2.2 ■ 30 Q	P3.1 ■ 29 P	P3.2 ■ 24 P	P4.1 ■ 18 P	M1.1 ▣ 14 P	M1.2 ▣ 12 P	M2.1 ▣ 12 P	M2.2 ▣ 10 P	M3.1 ▣ 12 P	M3.2 ▣ 10 P
K1.1 ■ 40 Q	K1.2 ■ 30 Q	K1.3 ■ 22 Q	K2.1 ■ 37 Q	K2.2 ■ 30 Q	K3.1 ■ 33 Q	K3.2 ■ 25 Q	K4.1 ■ 30 P	K4.2 ■ 23 P	K5.1 ■ 34 Q	K5.2 ■ 26 Q	N1.1 ■ 600 R	N1.2 ■ 450 R	N1.3 ■ 300 R
N2.1 ■ 769 R	N2.2 ■ 692 R	N2.3 ■ 500 R	N3.1 ■ 339 R	N3.2 ■ 200 R	N3.3 ■ 100 Q	N4.1 ■ 60 R							

Product	DC (mm)	CW (mm)	DCON MS (mm)	NOF	P (mm)	DHUB (mm)	DAH4 (mm)	DBC4 (mm)	DAH5 (mm)	DBC5 (mm)	DAH6 (mm)	DBC6 (mm)
D752250.0X2.0X128	250.00	2.0	32.00	128	6	100	8	45	9	50	11	63
D752300.0X2.5X160	300.00	2.5	32.00	160	6	100	8	45	9	50	11	63
D752315.0X2.5X160	315.00	2.5	32.00	160	6	100	8	45	9	50	11	63
D752350.0X2.5X180	350.00	2.5	32.00	180	6	120	8	45	9	50	11	63

D753



Sierra circular HSS de paso grande

Diseñada con paso grande, ideal para componentes de sección delgada. El rectificado y la geometría neutra de los dientes, además de ayudar a controlar la viruta, también previenen el roce al cortar tubos y tuberías. Adecuada para ranurar y cortar. El acabado de óxido al vapor actúa para retener el fluido de corte y evitar la soldadura de la viruta en la herramienta.

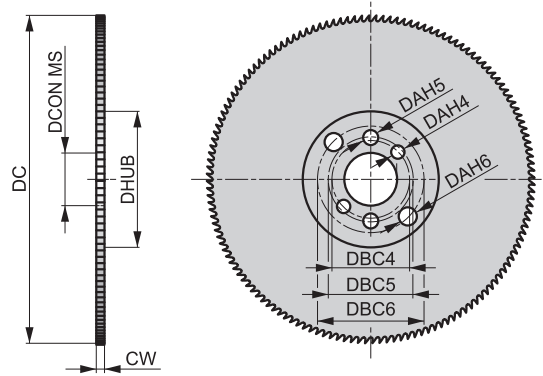

HSS

18°



Grupo de Material de la pieza adecuado. Valores de inicio de la velocidad de corte (m/min) y código alfabético. Las tablas con avances por diente y factores de corrección en la pag. 261.

P1.1 ■ 40 Q	P1.2 ■ 45 Q	P1.3 ■ 46 Q	P2.1 ■ 34 Q	P2.2 ■ 30 Q	P3.1 ■ 29 P	P3.2 ■ 24 P	P4.1 ■ 18 P	M1.1 ▧ 14 P	M1.2 ▧ 12 P	M2.1 ▧ 12 P	M2.2 ▧ 10 P	M3.1 ▧ 12 P	M3.2 ▧ 10 P
K1.1 ■ 40 Q	K1.2 ■ 30 Q	K1.3 ■ 22 Q	K2.1 ■ 37 Q	K2.2 ■ 30 Q	K3.1 ■ 33 Q	K3.2 ■ 25 Q	K4.1 ■ 30 P	K4.2 ■ 23 P	K5.1 ■ 34 Q	K5.2 ■ 26 Q	N1.1 ■ 600 R	N1.2 ■ 450 R	N1.3 ■ 300 R
N2.1 ■ 769 R	N2.2 ■ 692 R	N2.3 ■ 500 R	N3.1 ■ 339 R	N3.2 ■ 200 R	N3.3 ■ 100 Q	N4.1 ■ 60 R							

Product	DC (mm)	CW (mm)	DCON MS (mm)	NOF	P (mm)	DHUB (mm)	DAH4 (mm)	DBC4 (mm)	DAH5 (mm)	DBC5 (mm)	DAH6 (mm)	DBC6 (mm)
D753250.0X2.0	250.00	2.0	32.00	100	8	100	8	45	9	50	11	63
D753350.0X2.5	350.00	2.5	32.00	140	8	120	8	45	9	50	11	63

D763

DORMER



Fresa HSS-E con Corte Lateral y Frontal de paso fino

Diseñada con paso fino ideal para ranuras estrechas y profundas, la geometría escalonada de los dientes escalonados ayuda a controlar las virutas durante el fresado. Una herramienta muy versátil que se puede utilizar para fresado horizontal de ranuras y aplicaciones de tronzado. El acabado brillante evita que el material de la pieza se adhiera a los filos de corte de la herramienta.

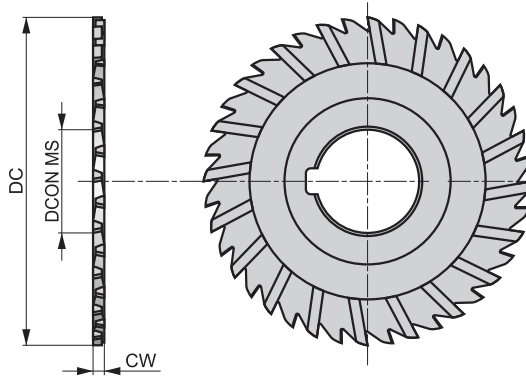

HSS-E		λ 15°
γ 10°	Bright	DC js16
DIN 885A		



Grupo de Material de la pieza adecuado. Valores de inicio de la velocidad de corte (m/min) y código alfabético. Las tablas con avances por diente y factores de corrección en la pag. 261.

P1.1 ■ 46 X	P1.2 ■ 52 X	P1.3 ■ 54 X	P2.1 ■ 40 X	P2.2 ■ 35 X	P2.3 ■ 31 X	P3.1 ■ 29 X	P3.2 ■ 24 X	P3.3 ■ 20 X	P4.1 ■ 18 X	P4.2 ■ 15 X	P4.3 ■ 12 X	M1.1 ■ 41 X	M1.2 ■ 35 X
M2.1 ■ 37 X	M2.2 ■ 30 X	M3.1 ■ 23 X	M3.2 ■ 20 X	M3.3 ■ 18 X	M4.1 ■ 10 X	K1.1 ■ 30 X	K1.2 ■ 22 X	K1.3 ■ 17 X	K2.1 ■ 49 X	K2.2 ■ 40 X	K2.3 ■ 32 X	K3.1 ■ 44 X	K3.2 ■ 33 X
K3.3 ■ 27 X	K4.1 ■ 40 X	K4.2 ■ 30 X	K4.3 ■ 22 X	K4.4 ■ 19 X	K4.5 ■ 16 X	K5.1 ■ 46 X	K5.2 ■ 34 X	K5.3 ■ 27 X	N1.1 ■ 83 X	N1.2 ■ 62 X	N1.3 ■ 42 X	N2.1 ■ 42 X	N2.2 ■ 37 X
N2.3 ■ 27 X	N3.1 ■ 44 X	N3.2 ■ 25 X	N3.3 ■ 13 X	N4.1 ■ 44 S	S1.1 ■ 30 V	S1.2 ■ 20 W	S1.3 ■ 15 W	S2.1 ■ 20 W	S2.2 ■ 14 S	S3.1 ■ 15 W	S3.2 ■ 10 S	S4.1 ■ 12 W	S4.2 ■ 8 S

Product	DC	CW	DCON MS	NOF
	(mm)	(mm)	(mm)	
D76363.0X1.6	63.00	1.6	22.00	32
D76363.0X2.0	63.00	2.0	22.00	32
D76380.0X3.0	80.00	3.0	27.00	32
D763100.0X2.0	100.00	2.0	32.00	44
D763125.0X3.0	125.00	3.0	32.00	44

D400



Fresa Frontal HSS-E, Acabado Brillante

Los tamaños estándar de los agujeros de montaje la hacen adecuada para conos portafresas. Diámetros hasta 50 mm. Adecuada para operaciones de corte y ranurado. Acabado brillante.

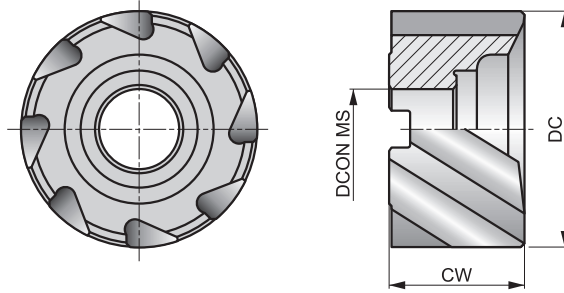

HSS-E	N	NOF 8
λ 30°	γ 12°	Bright
DC js16		DIN 1880



Grupo de Material de la pieza adecuado. Valores de inicio de la velocidad de corte (m/min) y código alfabético. Las tablas con avances por diente y factores de corrección en la pag. 261.

P1.1 ■ 40 C	P1.2 ■ 45 C	P1.3 ■ 46 C	P2.1 ■ 34 C	P2.2 ■ 30 C	P2.3 ▧ 27 B	P3.1 ■ 29 C	P3.2 ■ 24 B	P3.3 ▧ 20 B	P4.1 ■ 18 B	P4.2 ▧ 15 B	P4.3 ▧ 12 B	M1.1 ■ 34 C	M1.2 ■ 29 C
M2.1 ■ 31 C	M2.2 ■ 25 B	M3.1 ▧ 17 B	M3.2 ▧ 15 B	M3.3 ■ 14 A	M4.1 ■ 10 A	K1.1 ■ 20 C	K1.2 ■ 15 C	K1.3 ■ 11 C	K2.1 ■ 37 C	K2.2 ■ 30 C	K2.3 ■ 24 B	K3.1 ■ 33 C	K3.2 ■ 25 C
K3.3 ■ 20 A	K4.1 ■ 30 B	K4.2 ■ 23 B	K4.3 ■ 17 B	K4.4 ■ 14 A	K4.5 ■ 12 A	K5.1 ■ 34 B	K5.2 ■ 26 B	K5.3 ■ 20 B	N1.1 ▧ 76 E	N1.2 ▧ 57 D	N1.3 ■ 38 D	N2.1 ■ 38 C	N2.2 ■ 34 C
N2.3 ■ 25 C	N3.1 ■ 40 C	N3.2 ■ 23 C	N3.3 ■ 12 C	N4.1 ▧ 40 C	N4.2 ▧ 15 C	N4.3 ▧ 17 C	S1.1 ■ 30 B	S1.2 ▧ 20 B	S1.3 ▧ 10 A	S2.1 ▧ 13 A	S2.2 ▧ 7 A	S3.1 ▧ 10 A	S3.2 ▧ 5 A
S4.1 ▧ 8 A	S4.2 ▧ 4 A												

Product	DC (mm)	CW (mm)	DCON MS (mm)	NOF
D40040.0	40.00	32.0	16.00	8
D40050.0	50.00	36.0	22.00	8

D420

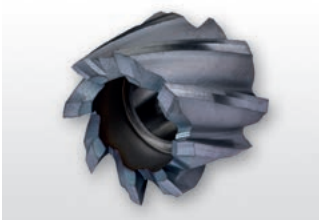

Fresa Frontal HSS-E, Recubrimiento TiCN

Los tamaños estándar de los agujeros de montaje la hacen adecuada para conos portafresas y se pueden utilizar en operaciones de corte y ranurado. Diámetros hasta 63 mm. El recubrimiento TiCN aumenta la vida de la herramienta y mejora el rendimiento en el fresado de materiales duros y abrasivos.

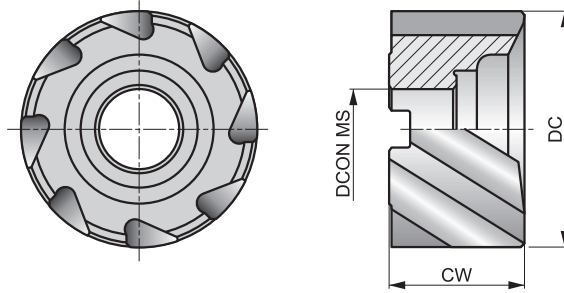

HSS-E	N	NOF 8
λ 30°	γ 12°	TiCN
DC js16		DIN 1880



Grupo de Material de la pieza adecuado. Valores de inicio de la velocidad de corte (m/min) y código alfabético. Las tablas con avances por diente y factores de corrección en la pag. 261.

P1.1 ■ 86 C	P1.2 ■ 96 C	P1.3 ■ 100 C	P2.1 ■ 74 C	P2.2 ■ 65 C	P2.3 ■ 57 B	P3.1 ■ 52 C	P3.2 ■ 42 B	P3.3 ■ 35 B	P4.1 ■ 31 B	P4.2 ■ 26 B	P4.3 ■ 21 B	M1.1 ■ 48 C	M1.2 ■ 41 C
M2.1 ■ 43 C	M2.2 ■ 35 B	M3.1 ■ 35 B	M3.2 ■ 30 B	M3.3 ■ 27 A	M4.1 ■ 20 A	K1.1 ■ 35 C	K1.2 ■ 26 C	K1.3 ■ 19 C	K2.1 ■ 62 C	K2.2 ■ 50 C	K2.3 ■ 40 B	K3.1 ■ 54 C	K3.2 ■ 42 C
K3.3 ■ 34 A	K4.1 ■ 50 B	K4.2 ■ 38 B	K4.3 ■ 28 B	K4.4 ■ 24 A	K4.5 ■ 20 A	K5.1 ■ 57 B	K5.2 ■ 43 B	K5.3 ■ 33 B	N1.1 ▧ 159 E	N1.2 ▧ 120 D	N1.3 ■ 80 D	N2.1 ■ 80 C	N2.2 ■ 72 C
N2.3 ■ 51 C	N3.1 ■ 84 C	N3.2 ■ 50 C	N3.3 ■ 25 C	N4.1 ■ 84 C	N4.2 ▧ 32 C	N4.3 ▧ 35 C	S1.1 ■ 35 B	S1.2 ■ 25 B	S1.3 ■ 15 A	S2.1 ■ 27 A	S2.2 ■ 14 A	S3.1 ■ 20 A	S3.2 ■ 10 A
S4.1 ■ 16 A	S4.2 ■ 8 A												

Product	DC (mm)	CW (mm)	DCON MS (mm)	NOF
D42063.0	63.00	40.0	27.00	8

D402



Fresas Frontales de HSS-E para desbaste, Acabado Brillante

Diseñada con perfil de desbaste NR y paso grande para una alto volumen de arranque de viruta en operaciones de desbaste. Agujeros estándar que permiten utilizar soportes estándar. Acabado brillante.

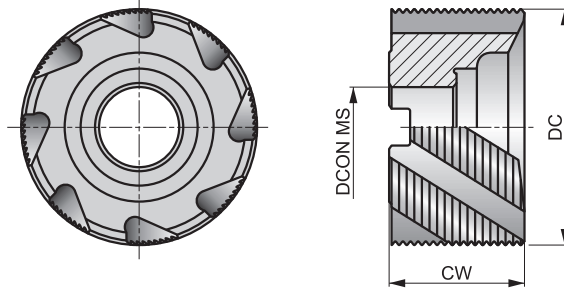

HSS-E	NR	NOF 8
λ 30°	γ 12°	Bright
DC js16		DIN 1880

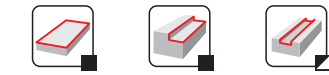

Grupo de Material de la pieza adecuado. Valores de inicio de la velocidad de corte (m/min) y código alfabético. Las tablas con avances por diente y factores de corrección en la pag. 261.

P1.1 ■ 40 D	P1.2 ■ 45 D	P1.3 ■ 46 D	P2.1 ■ 34 D	P2.2 ■ 30 D	P2.3 ▧ 27 C	P3.1 ■ 29 D	P3.2 ■ 24 C	P3.3 ▧ 20 C	P4.1 ■ 18 C	P4.2 ▧ 15 C	P4.3 ▧ 12 C	M1.1 ■ 34 D	M1.2 ■ 29 D
M2.1 ■ 31 D	M2.2 ■ 25 C	M3.1 ▧ 17 C	M3.2 ▧ 15 C	M3.3 ■ 14 B	M4.1 ■ 10 B	K1.1 ■ 20 D	K1.2 ■ 15 D	K1.3 ■ 11 D	K2.1 ■ 37 D	K2.2 ■ 30 D	K2.3 ■ 24 C	K3.1 ■ 33 D	K3.2 ■ 25 D
K3.3 ■ 20 B	K4.1 ■ 30 C	K4.2 ■ 23 C	K4.3 ■ 17 C	K4.4 ■ 14 B	K4.5 ■ 12 B	K5.1 ■ 34 C	K5.2 ■ 26 C	K5.3 ■ 20 C	N1.1 ▧ 76 F	N1.2 ▧ 57 E	N1.3 ■ 38 E	N2.1 ■ 38 D	N2.2 ■ 34 D
N2.3 ■ 25 D	N3.1 ■ 40 D	N3.2 ■ 23 D	N3.3 ■ 12 D	N4.1 ▧ 40 D	N4.2 ▧ 15 D	N4.3 ▧ 17 D	S1.1 ■ 30 C	S1.2 ▧ 20 C	S1.3 ▧ 10 B	S2.1 ▧ 13 B	S2.2 ▧ 7 B	S3.1 ▧ 10 B	S3.2 ▧ 5 B
S4.1 ▧ 8 B	S4.2 ▧ 4 B												

Product	DC (mm)	CW (mm)	DCON MS (mm)	NOF
D40263.0	63.00	40.0	27.00	8

Código de Material (BMC)	HM	HM	HM	HM	HM	HM	HM						
Perfil de la fresa	N	N	N	N	N	N							
Número de canales (NOF)	NOF 2	NOF 2	NOF 3	NOF 3	NOF 4	NOF 4							
Longitud de corte													
Ángulo de hélice (FHA)	λ 30°	λ 30°	λ 30°	λ 30°	λ 30°	λ 30°							
Ángulo de hélice (FHA)	λ 30°	λ 30°	λ 30°	λ 30°	λ 30°	λ 30°							
Ángulo de incidencia radial (GAMF)	γ 12°	γ 12°	γ 12°	γ 12°	γ 12°	γ 12°							
Mango													
Recubrimiento	Bright	TiAlN	Bright	TiAlN	Bright	TiAlN							
Clase de tolerancia del diámetro de corte (TCDC)	DC h10	DC h10	DC h10	DC h10	DC h12	DC h12							
Dirección													
Grupo básico estándar (BSG)													

Código de Familia de Producto		S902	S922	S903	S933	S904	S944	S991					
Gama de diámetros de corte PSF		2.00 – 20.00	2.00 – 20.00	2.00 – 20.00	2.00 – 20.00	2.00 – 20.00	2.00 – 20.00	Set					
P	P1	■	■	■	■	■	■						
	P2	■	■	■	■	■	■						
	P3	■	■	■	■	■	■						
	P4	▣	■	▣	■	▣	■						
M	M1												
	M2												
	M3												
	M4												
K	K1	▣	■	▣	■	▣	■						
	K2	■	■	■	■	■	■						
	K3	■	■	■	■	■	■						
	K4	▣	■	▣	■	▣	■						
	K5	■	■	■	■	■	■						
N	N1	▣	▣	▣	▣	▣	▣						
	N2	▣	■	▣	■	▣	■						
	N3	■	■	■	■	■	■						
	N4	▣	▣	▣	▣	▣	▣						
	N5												
S	S1	▣	▣	▣	▣	▣	▣						
	S2					▣	▣						
	S3					▣	▣						
	S4					▣	▣						
H	H1												
	H2												
	H3												
	H4												

S902



Fresa de Metal Duro de 2 Filos

Fresa con longitud de corte media de 2 filos con hélice de 30° que proporciona alta rigidez en el fresado de ranuras estándar.

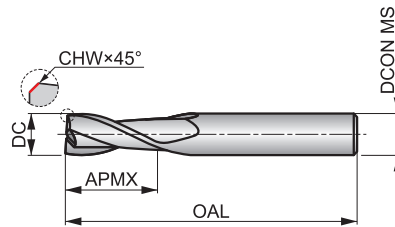

HM	N	NOF 2
	λ 30°	γ 12°
DIN 6535HA	Bright	DC h10



Grupo de Material de la pieza adecuado. Valores de inicio de la velocidad de corte (m/min) y código alfabético. Las tablas con avances por diente y factores de corrección en la pag. 266.

P1.1 ■ 106 K	P1.2 ■ 119 K	P1.3 ■ 123 K	P2.1 ■ 91 K	P2.2 ■ 80 K	P2.3 ▣ 71 J	P3.1 ■ 66 K	P3.2 ■ 53 J	P3.3 ▣ 45 J	P4.1 ■ 40 J	P4.2 ▣ 34 J	K1.1 ■ 80 K	K1.2 ▣ 59 K	K1.3 ▣ 44 K
K2.1 ■ 98 K	K2.2 ■ 80 K	K2.3 ▣ 64 J	K3.1 ■ 87 K	K3.2 ■ 67 K	K3.3 ▣ 54 J	K4.1 ■ 81 J	K4.2 ■ 61 J	K4.3 ▣ 45 J	K4.4 ▣ 38 J	K4.5 ▣ 32 J	K5.1 ■ 91 J	K5.2 ■ 69 J	K5.3 ▣ 53 J
N1.1 ▣ 355 K	N1.2 ■ 267 K	N1.3 ■ 179 K	N2.1 ■ 179 K	N2.2 ▣ 160 K	N2.3 ▣ 115 K	N3.1 ■ 187 K	N3.2 ■ 109 K	N3.3 ■ 56 K	N4.1 ▣ 187 K	N4.2 ▣ 172 K	S1.1 ■ 38 J	S1.2 ▣ 36 J	S1.3 ▣ 15 J

DCON MS tolerancia h6; DC ≤ 10.00 mm: CHW ± 0.03 × 45° mm; DC > 10.00 mm: CHW ± 0.05 × 45° mm.

Product	DC (mm)	CHW (mm)	DCON MS (mm)	APM× (mm)	OAL (mm)	NOF
S9022.0	2.00	0.08	3.00	6.00	38.0	2
S9022.5	2.50	0.08	3.00	9.00	38.0	2
S9023.0	3.00	0.08	3.00	12.00	38.0	2
S9024.0	4.00	0.08	4.00	14.00	50.0	2
S9025.0	5.00	0.13	5.00	16.00	50.0	2
S9026.0	6.00	0.13	6.00	19.00	57.0	2
S9027.0	7.00	0.13	8.00	19.00	63.0	2
S9028.0	8.00	0.13	8.00	19.00	63.0	2
S9029.0	9.00	0.13	10.00	21.00	72.0	2
S90210.0	10.00	0.18	10.00	22.00	72.0	2
S90212.0	12.00	0.20	12.00	25.00	73.0	2
S90214.0	14.00	0.20	14.00	30.00	83.0	2
S90216.0	16.00	0.20	16.00	32.00	92.0	2
S90218.0	18.00	0.20	18.00	32.00	92.0	2
S90220.0	20.00	0.30	20.00	38.00	104.0	2

S922



Fresa de Metal Duro de 2 Filos

Fresa con longitud de corte media de 2 filos con hélice de 30° que proporciona alta rigidez en el fresado de ranuras estándar. Mango cilíndrico a partir de Ø5 mm. Recubrimiento TiAlN para mayor resistencia a la temperatura y mayor vida de la herramienta.

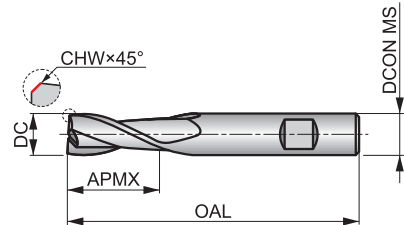

HM	N	NOF 2
	λ 30°	γ 12°
DIN 6535HB	TiAlN	DC h10



Grupo de Material de la pieza adecuado. Valores de inicio de la velocidad de corte (m/min) y código alfabético. Las tablas con avances por diente y factores de corrección en la pag. 266.

P1.1 ■ 132 K	P1.2 ■ 148 K	P1.3 ■ 153 K	P2.1 ■ 113 K	P2.2 ■ 100 K	P2.3 ■ 88 J	P3.1 ■ 98 K	P3.2 ■ 79 J	P3.3 ■ 67 J	P4.1 ■ 59 J	P4.2 ■ 50 J	P4.3 ▣ 41 J	K1.1 ■ 100 K	K1.2 ■ 74 K
K1.3 ■ 56 K	K2.1 ■ 107 K	K2.2 ■ 87 K	K2.3 ■ 70 J	K3.1 ■ 95 K	K3.2 ■ 72 K	K3.3 ■ 59 J	K4.1 ■ 88 J	K4.2 ■ 67 J	K4.3 ■ 49 J	K4.4 ■ 42 J	K4.5 ■ 35 J	K5.1 ■ 100 J	K5.2 ■ 75 J
K5.3 ■ 58 J	N1.1 ▣ 296 K	N1.2 ▣ 222 K	N1.3 ■ 149 K	N2.1 ■ 149 K	N2.2 ■ 133 K	N2.3 ■ 96 K	N3.1 ■ 156 K	N3.2 ■ 91 K	N3.3 ▣ 47 K	N4.1 ▣ 156 K	N4.2 ▣ 60 K	N4.3 ▣ 64 K	S1.1 ■ 47 J
S1.2 ▣ 45 J	S1.3 ▣ 20 J												

DCON MS tolerancia h6; DC ≤ 10.00 mm: CHW ± 0.03 × 45° mm; DC > 10.00 mm: CHW ± 0.05 × 45° mm. Los productos de esta serie también están disponibles en forma de Set. Por favor, vea S991.

Product	DC (mm)	CHW (mm)	DCON MS (mm)	APM× (mm)	OAL (mm)	NOF
S9222.0 ¹⁾	2.00	0.08	3.00	6.00	38.0	2
S9222.5 ¹⁾	2.50	0.08	3.00	9.00	38.0	2
S9223.0 ¹⁾	3.00	0.08	3.00	12.00	38.0	2
S9224.0 ¹⁾	4.00	0.08	4.00	14.00	50.0	2
S9225.0 ¹⁾	5.00	0.13	5.00	16.00	50.0	2
S9226.0	6.00	0.13	6.00	19.00	57.0	2
S9227.0	7.00	0.13	8.00	19.00	63.0	2
S9228.0	8.00	0.13	8.00	19.00	63.0	2
S9229.0	9.00	0.13	10.00	21.00	72.0	2
S92210.0	10.00	0.18	10.00	22.00	72.0	2
S92212.0	12.00	0.20	12.00	25.00	73.0	2
S92214.0	14.00	0.20	14.00	30.00	83.0	2
S92216.0	16.00	0.20	16.00	32.00	92.0	2
S92218.0	18.00	0.20	18.00	32.00	92.0	2
S92220.0	20.00	0.30	20.00	38.00	104.0	2

¹⁾ Mango cilíndrico

S903



Fresa de Metal Duro de 3 Filos

Fresa con longitud de corte media de 3 filos con hélice de 30°, que proporciona alta rigidez en el fresado de ranuras estándar.

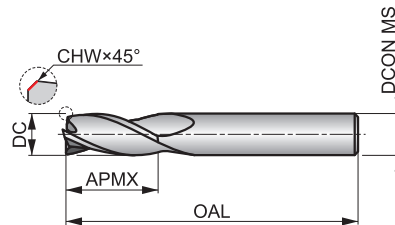

HM	N	NOF 3
	λ 30°	γ 12°
DIN 6535HA	Bright	DC h10



Grupo de Material de la pieza adecuado. Valores de inicio de la velocidad de corte (m/min) y código alfabético. Las tablas con avances por diente y factores de corrección en la pag. 266.

P1.1 ■ 106 J	P1.2 ■ 119 J	P1.3 ■ 123 J	P2.1 ■ 91 J	P2.2 ■ 80 J	P2.3 ▣ 71 I	P3.1 ■ 66 J	P3.2 ■ 53 I	P3.3 ▣ 45 I	P4.1 ■ 40 I	P4.2 ▣ 34 I	K1.1 ■ 80 J	K1.2 ▣ 59 J	K1.3 ▣ 44 J
K2.1 ■ 98 J	K2.2 ■ 80 J	K2.3 ▣ 64 I	K3.1 ■ 87 J	K3.2 ■ 67 J	K3.3 ▣ 54 I	K4.1 ■ 81 I	K4.2 ■ 61 I	K4.3 ▣ 45 I	K4.4 ▣ 38 I	K4.5 ▣ 32 I	K5.1 ■ 91 I	K5.2 ■ 69 I	K5.3 ▣ 53 I
N1.1 ▣ 355 K	N1.2 ■ 267 K	N1.3 ■ 179 K	N2.1 ■ 179 J	N2.2 ▣ 160 J	N2.3 ▣ 115 J	N3.1 ■ 187 J	N3.2 ■ 109 J	N3.3 ■ 56 J	N4.1 ▣ 187 J	N4.2 ▣ 172 J	S1.1 ■ 38 I	S1.2 ▣ 36 I	S1.3 ▣ 43 I

DCON MS tolerancia h6; DC ≤ 9.00 mm: CHW ± 0.03 × 45° mm; DC > 9.00 mm: CHW ± 0.05 × 45° mm.

Product	DC (mm)	CHW (mm)	DCON MS (mm)	APM× (mm)	OAL (mm)	NOF
S9032.0	2.00	0.08	3.00	6.00	38.0	3
S9032.5	2.50	0.08	3.00	9.00	38.0	3
S9033.0	3.00	0.08	3.00	12.00	38.0	3
S9034.0	4.00	0.08	4.00	14.00	50.0	3
S9035.0	5.00	0.13	5.00	16.00	50.0	3
S9036.0	6.00	0.13	6.00	19.00	57.0	3
S9037.0	7.00	0.13	8.00	19.00	63.0	3
S9038.0	8.00	0.13	8.00	19.00	63.0	3
S9039.0	9.00	0.13	10.00	21.00	72.0	3
S90310.0	10.00	0.20	10.00	22.00	72.0	3
S90312.0	12.00	0.20	12.00	25.00	73.0	3
S90314.0	14.00	0.20	14.00	30.00	83.0	3
S90316.0	16.00	0.20	16.00	32.00	92.0	3
S90318.0	18.00	0.20	18.00	32.00	92.0	3
S90320.0	20.00	0.30	20.00	38.00	104.0	3

S933



Fresa de Metal Duro de 3 Filos

Fresa con longitud de corte media de 3 filos con hélice de 30°, que proporciona alta rigidez en el fresado de ranuras estándar. Mango cilíndrico para diámetros mayores de 5 mm. Recubrimiento TiAlN para mayor resistencia a la temperatura y mayor vida de la herramienta.

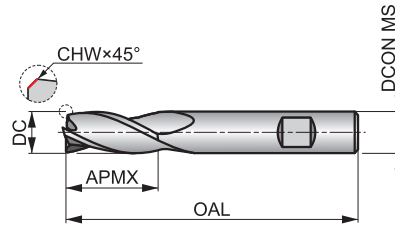

HM	N	NOF 3
	λ 30°	γ 12°
DIN 6358B	TiAlN	DC h10
	DORMER	



Grupo de Material de la pieza adecuado. Valores de inicio de la velocidad de corte (m/min) y código alfabético. Las tablas con avances por diente y factores de corrección en la pag. 266.

P1.1 ■ 132 J	P1.2 ■ 148 J	P1.3 ■ 153 J	P2.1 ■ 113 J	P2.2 ■ 100 J	P2.3 ■ 88 I	P3.1 ■ 98 J	P3.2 ■ 79 I	P3.3 ■ 67 I	P4.1 ■ 59 I	P4.2 ■ 50 I	P4.3 □ 41 I	K1.1 ■ 100 J	K1.2 ■ 74 J
K1.3 ■ 56 J	K2.1 ■ 107 J	K2.2 ■ 87 J	K2.3 ■ 70 I	K3.1 ■ 95 J	K3.2 ■ 72 J	K3.3 ■ 59 I	K4.1 ■ 88 I	K4.2 ■ 67 I	K4.3 ■ 49 I	K4.4 ■ 42 I	K4.5 ■ 35 I	K5.1 ■ 100 I	K5.2 ■ 75 I
K5.3 ■ 58 I	N1.1 □ 296 K	N1.2 □ 222 K	N1.3 ■ 149 K	N2.1 ■ 149 J	N2.2 ■ 133 J	N2.3 ■ 96 J	N3.1 ■ 156 J	N3.2 ■ 91 J	N3.3 □ 47 J	N4.1 □ 156 J	N4.2 □ 60 J	N4.3 □ 64 J	S1.1 ■ 47 I
S1.2 □ 45 I	S1.3 □ 20 I												

DCON MS tolerancia h6; DC ≤ 9.00 mm: CHW ± 0.03 × 45° mm; DC > 9.00 mm: CHW ± 0.05 × 45° mm.
Los productos de esta serie también están disponibles en forma de Set. Por favor, vea S991.

Product	DC (mm)	CHW (mm)	DCON MS (mm)	APM× (mm)	OAL (mm)	NOF
S9332.0 ¹⁾	2.00	0.08	3.00	6.00	38.0	3
S9332.5 ¹⁾	2.50	0.08	3.00	9.00	38.0	3
S9333.0 ¹⁾	3.00	0.08	3.00	12.00	38.0	3
S9334.0 ¹⁾	4.00	0.08	4.00	14.00	50.0	3
S9335.0 ¹⁾	5.00	0.13	5.00	16.00	50.0	3
S9336.0	6.00	0.13	6.00	19.00	57.0	3
S9337.0	7.00	0.13	8.00	19.00	63.0	3
S9338.0	8.00	0.13	8.00	19.00	63.0	3
S9339.0	9.00	0.13	10.00	21.00	72.0	3
S93310.0	10.00	0.20	10.00	22.00	72.0	3
S93312.0	12.00	0.20	12.00	25.00	73.0	3
S93314.0	14.00	0.20	14.00	30.00	83.0	3
S93316.0	16.00	0.20	16.00	32.00	92.0	3
S93318.0	18.00	0.20	18.00	32.00	92.0	3
S93320.0	20.00	0.30	20.00	38.00	104.0	3

¹⁾ Mango cilíndrico

S904



Fresa de Metal Duro de 4 Filos

Fresa con longitud de corte media de 4 filos con hélice de 30°, que proporciona alta rigidez en el fresado de ranuras estándar.

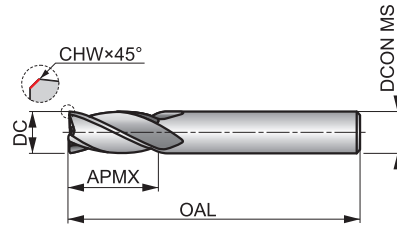

HM	N	NOF 4
	λ 30°	γ 12°
DIN 6535HA	Bright	DC h12



Grupo de Material de la pieza adecuado. Valores de inicio de la velocidad de corte (m/min) y código alfabético. Las tablas con avances por diente y factores de corrección en la pag. 266.

P1.1 ■ 106 J	P1.2 ■ 119 J	P1.3 ■ 123 J	P2.1 ■ 91 J	P2.2 ■ 80 J	P2.3 ▣ 71 I	P3.1 ■ 66 J	P3.2 ■ 53 I	P3.3 ▣ 45 I	P4.1 ■ 40 I	P4.2 ▣ 34 I	P4.3 ▣ 18 I	K1.1 ■ 80 J	K1.2 ▣ 59 I
K1.3 ▣ 44 J	K2.1 ■ 98 J	K2.2 ■ 80 J	K2.3 ▣ 64 I	K3.1 ■ 87 J	K3.2 ■ 67 J	K3.3 ▣ 54 I	K4.1 ■ 81 I	K4.2 ■ 61 I	K4.3 ▣ 45 I	K4.4 ▣ 38 I	K4.5 ▣ 32 I	K5.1 ■ 91 I	K5.2 ■ 69 I
K5.3 ▣ 53 I	N1.1 ▣ 355 J	N1.2 ■ 267 J	N1.3 ■ 179 J	N2.1 ■ 179 J	N2.2 ▣ 160 J	N2.3 ▣ 115 J	N3.1 ■ 187 J	N3.2 ■ 109 J	N3.3 ■ 56 J	N4.1 ▣ 187 J	N4.2 ▣ 72 J	S1.1 ■ 38 I	S1.2 ▣ 36 I
S1.3 ▣ 43 I	S2.1 ▣ 40 I	S2.2 ▣ 35 I	S3.1 ▣ 30 I	S3.2 ▣ 25 I	S4.1 ▣ 23 I	S4.2 ▣ 20 I							

DCON MS tolerancia h6; DC ≤ 9.00 mm: CHW ± 0.03 × 45° mm; DC > 9.00 mm: CHW ± 0.05 × 45° mm.

Product	DC (mm)	CHW (mm)	DCON MS (mm)	APM× (mm)	OAL (mm)	NOF
S9042.0	2.00	0.08	3.00	6.00	38.0	4
S9042.5	2.50	0.08	3.00	9.00	38.0	4
S9043.0	3.00	0.08	3.00	12.00	38.0	4
S9044.0	4.00	0.08	4.00	14.00	50.0	4
S9045.0	5.00	0.13	5.00	16.00	50.0	4
S9046.0	6.00	0.13	6.00	19.00	57.0	4
S9047.0	7.00	0.13	8.00	19.00	63.0	4
S9048.0	8.00	0.13	8.00	19.00	63.0	4
S9049.0	9.00	0.13	10.00	21.00	72.0	4
S90410.0	10.00	0.20	10.00	22.00	72.0	4
S90412.0	12.00	0.20	12.00	25.00	73.0	4
S90414.0	14.00	0.20	14.00	30.00	83.0	4
S90416.0	16.00	0.20	16.00	32.00	92.0	4
S90418.0	18.00	0.20	18.00	32.00	92.0	4
S90420.0	20.00	0.30	20.00	38.00	104.0	4

S944



Fresa de Metal Duro de 4 Filos

Fresa con longitud de corte media de 4 filos con hélice de 30°, que proporciona alta rigidez en el fresado de ranuras estándar. Mango cilíndrico para diámetros mayores de 5 mm. Recubrimiento TiAlN para mayor resistencia a la temperatura y mayor vida de la herramienta.

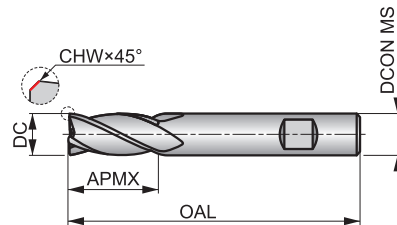

HM	N	NOF 4
	λ 30°	γ 12°
DIN 6335HB	TiAlN	DC h12
	DORMER	



Grupo de Material de la pieza adecuado. Valores de inicio de la velocidad de corte (m/min) y código alfabético. Las tablas con avances por diente y factores de corrección en la pag. 266.

P1.1 ■ 132 J	P1.2 ■ 148 J	P1.3 ■ 153 J	P2.1 ■ 113 J	P2.2 ■ 100 J	P2.3 ■ 88 l	P3.1 ■ 98 J	P3.2 ■ 79 l	P3.3 ■ 67 l	P4.1 ■ 59 l	P4.2 ■ 50 l	P4.3 □ 41 l	K1.1 ■ 100 J	K1.2 ■ 74 J
K1.3 ■ 56 J	K2.1 ■ 107 J	K2.2 ■ 87 J	K2.3 ■ 70 l	K3.1 ■ 95 J	K3.2 ■ 72 J	K3.3 ■ 59 l	K4.1 ■ 88 l	K4.2 ■ 67 l	K4.3 ■ 49 l	K4.4 ■ 42 l	K4.5 ■ 35 l	K5.1 ■ 100 l	K5.2 ■ 75 l
K5.3 ■ 58 l	N1.1 □ 296 J	N1.2 □ 222 J	N1.3 ■ 149 J	N2.1 ■ 149 J	N2.2 ■ 133 J	N2.3 ■ 96 J	N3.1 ■ 156 J	N3.2 ■ 91 J	N3.3 □ 47 J	N4.1 □ 156 J	N4.2 □ 60 J	N4.3 □ 64 J	S1.1 ■ 47 l
S1.2 □ 45 l	S1.3 □ 45 l	S2.1 □ 60 l	S2.2 □ 49 l	S3.1 □ 45 l	S3.2 □ 35 l	S4.1 □ 35 l	S4.2 □ 28 l						

DCON MS tolerancia h6; DC ≤ 9.00 mm: CHW ± 0.03 × 45° mm; DC > 9.00 mm: CHW ± 0.05 × 45° mm.
Los productos de esta serie también están disponibles en forma de Set. Por favor, vea S991.

Product	DC (mm)	CHW (mm)	DCON MS (mm)	APM× (mm)	OAL (mm)	NOF
S9442.0 ¹⁾	2.00	0.08	3.00	6.00	38.0	4
S9442.5 ¹⁾	2.50	0.08	3.00	9.00	38.0	4
S9443.0 ¹⁾	3.00	0.08	3.00	12.00	38.0	4
S9444.0 ¹⁾	4.00	0.08	4.00	14.00	50.0	4
S9445.0 ¹⁾	5.00	0.13	5.00	16.00	50.0	4
S9446.0	6.00	0.13	6.00	19.00	57.0	4
S9447.0	7.00	0.13	8.00	19.00	63.0	4
S9448.0	8.00	0.13	8.00	19.00	63.0	4
S9449.0	9.00	0.13	10.00	21.00	72.0	4
S94410.0	10.00	0.20	10.00	22.00	72.0	4
S94412.0	12.00	0.20	12.00	25.00	73.0	4
S94414.0	14.00	0.20	14.00	30.00	83.0	4
S94416.0	16.00	0.20	16.00	32.00	92.0	4
S94418.0	18.00	0.20	18.00	32.00	92.0	4
S94420.0	20.00	0.30	20.00	38.00	104.0	4

¹⁾ Mango cilíndrico



S991



Juego de Fresas de Metal Duro

Juego de fresas de metal duro con recubrimiento TiAlN. Gama S922, S933 o S944 (2, 3 o 4 filos). El juego contiene Ø3, 4, 5, 6, 8 y 10 mm. Presentadas en una caja de plástico.

HM		

A=Tipos en el Juego, B=No en el Juego, C=Diámetros en el Juego

Product	A	B	C
S991SET922	S922	6	0 3.00 mm, 4.00 mm, 5.00 mm, 6.00 mm, 8.00 mm, 10.00 mm
S991SET933	S933	6	0 3.00 mm, 4.00 mm, 5.00 mm, 6.00 mm, 8.00 mm, 10.00 mm
S991SET944	S944	6	0 3.00 mm, 4.00 mm, 5.00 mm, 6.00 mm, 8.00 mm, 10.00 mm



PMK
NSH



**HERRAMIENTAS DE METAL DURO PARA FABRICACIÓN MIXTA.
ADECUADAS PARA PARÁMETROS DE CORTE MODERADOS.**

Código de Material (BMC)	HM	HM	HM	HM	HM	HM	HM	HM	HM	HM	HM	HM	HM	HM
Perfil de la fresa	N	N	N	N	N	N	N	N	N	N	N	N	N	N
Número de canales (NOF)	NOF 2	NOF 2	NOF 2	NOF 2	NOF 2	NOF 2	NOF 3	NOF 3	NOF 3	NOF 3	NOF 3	NOF 3	NOF 3	NOF 3
Longitud de corte														
Ángulo de hélice (FHA)	λ 28°	λ 28°	λ 28°	λ 28°	λ 40°	λ 28°	λ 28°	λ 28°	λ 28°	λ 28°	λ 40°	λ 28°	λ 40°	λ 40°
Ángulo de hélice (FHA)	λ 28°	λ 28°	λ 28°	λ 28°	λ 40°	λ 28°	λ 28°	λ 28°	λ 28°	λ 28°	λ 40°	λ 28°	λ 40°	λ 40°
Ángulo de incidencia radial (GAMF)	γ 9°	γ 9°	γ 9°	γ 9°	γ 10°	γ 9°	γ 9°	γ 9°	γ 9°	γ 9°	γ 10°	γ 9°	γ 10°	γ 10°
Mango														
Recubrimiento														
Clase de tolerancia del diámetro de corte (TCDC)	DC h9	DC h9	DC h9	DC h9	DC h9	DC h9	DC h9	DC h9	DC h9	DC h9	DC h9	DC h9	DC h9	DC h9
Dirección														
Grupo básico estándar (BSG)	DIN 6527K	DIN 6527K	DIN 6527L	DIN 6527L	DORNER	DORNER	DIN 6527K	DIN 6527K	DIN 6527L	DIN 6527L	DORNER	DORNER	DORNER	DORNER
Código de Familia de Producto	S802HA	S802HB	S812HA	S812HB	S710	S822	S803HA	S803HB	S813HA	S813HB	S713	S823	S714	S715
Gama de diámetros de corte PSF	1.00 – 20.00	2.00 – 20.00	2.00 – 20.00	2.00 – 20.00	1.00 – 20.00	2.00 – 20.00	1.00 – 20.00	2.00 – 20.00	2.00 – 20.00	2.00 – 20.00	1.50 – 20.00	2.00 – 20.00	3.00 – 20.00	3.00 – 20.00
P	P1	■	■	■	■	■	■	■	■	■	■	■	■	■
	P2	■	■	■	■	■	■	■	■	■	■	■	■	■
	P3	■	■	■	■	■	■	■	■	■	■	■	■	■
	P4	■	■	■	■	■	■	■	■	■	■	■	■	■
M	M1	■	■	■	■	■	■	■	■	■	■	■	■	■
	M2	■	■	■	■	■	■	■	■	■	■	■	■	■
	M3	■	■	■	■	■	■	■	■	■	■	■	■	■
	M4	■	■	■	■	■	■	■	■	■	■	■	■	■
K	K1	■	■	■	■	■	■	■	■	■	■	■	■	■
	K2	■	■	■	■	■	■	■	■	■	■	■	■	■
	K3	■	■	■	■	■	■	■	■	■	■	■	■	■
	K4	■	■	■	■	■	■	■	■	■	■	■	■	■
	K5	■	■	■	■	■	■	■	■	■	■	■	■	■
N	N1	■	■	■	■	■	■	■	■	■	■	■	■	■
	N2	■	■	■	■	■	■	■	■	■	■	■	■	■
	N3	■	■	■	■	■	■	■	■	■	■	■	■	■
	N4	■	■	■	■	■	■	■	■	■	■	■	■	■
	N5	■	■	■	■	■	■	■	■	■	■	■	■	■
S	S1	■	■	■	■	■	■	■	■	■	■	■	■	■
	S2	■	■	■	■	■	■	■	■	■	■	■	■	■
	S3	■	■	■	■	■	■	■	■	■	■	■	■	■
	S4	■	■	■	■	■	■	■	■	■	■	■	■	■
H	H1													
	H2													
	H3													
	H4													

S802HA

DORMER



Fresa de Metal Duro de 2 Filos para Ranurado, Mango HA DIN 6535

Fresa con longitud de corte extra corta de 2 filos que proporciona alta rigidez para fresado de ranuras poco profundas con tolerancia P9 y operaciones de fresado en rampa. El recubrimiento AlCrN mejora el rendimiento y alarga la vida de la herramienta.

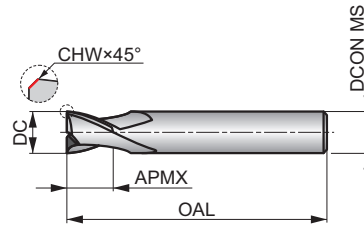

HM	N	NOF 2
	λ 28°	γ 9°
DIN 6535HA	AlCrN	
DIN 6527K		



Grupo de Material de la pieza adecuado. Valores de inicio de la velocidad de corte (m/min) y código alfabético. Las tablas con avances por diente y factores de corrección en la pag. 266.

P1.1 ■ 206 K	P1.2 ■ 230 K	P1.3 ■ 238 K	P2.1 ■ 176 K	P2.2 ■ 155 K	P2.3 ■ 137 J	P3.1 ■ 143 K	P3.2 ■ 114 J	P3.3 ■ 97 J	P4.1 ■ 84 J	P4.2 ■ 72 J	P4.3 ■ 58 J	M1.1 ■ 121 K	M1.2 ■ 102 K
M2.1 ■ 107 K	M2.2 ■ 89 J	M2.3 ▣ 75 J	M3.1 ■ 99 J	M3.2 ■ 85 J	M3.3 ▣ 76 J	M4.1 ▣ 75 J	M4.2 ▣ 63 J	K1.1 ■ 205 K	K1.2 ■ 152 K	K1.3 ■ 114 K	K2.1 ■ 210 K	K2.2 ■ 171 K	K2.3 ■ 137 J
K3.1 ■ 186 K	K3.2 ■ 143 K	K3.3 ■ 115 J	K4.1 ■ 173 J	K4.2 ■ 131 J	K4.3 ■ 95 J	K4.4 ■ 82 J	K4.5 ■ 68 J	K5.1 ■ 196 J	K5.2 ■ 147 J	K5.3 ■ 114 J	N1.1 ▣ 408 K	N1.2 ▣ 307 K	N1.3 ■ 206 K
N2.1 ■ 206 K	N2.2 ■ 184 K	N2.3 ■ 132 K	N3.1 ■ 215 K	N3.2 ■ 125 K	N3.3 ▣ 64 K	N4.1 ▣ 215 K	N4.2 ▣ 83 K	S1.1 ▣ 81 J	S1.2 ▣ 71 J	S2.1 ▣ 55 J	S3.1 ▣ 41 J	S4.1 ▣ 32 J	

DCON MS tolerancia h6; DC ≤ 7.75 mm: CHW ±0.03×45° mm; DC > 7.75 mm: CHW ±0.05×45° mm.

Product	DC (mm)	CHW (mm)	DCON MS (mm)	APMX (mm)	OAL (mm)	NOF
S802HA1.0	1.00	—	3.00	3.00	38.0	2
S802HA1.5	1.50	—	3.00	3.00	38.0	2
S802HA2.0	2.00	—	6.00	3.00	50.0	2
S802HA2.5	2.50	0.08	6.00	3.00	50.0	2
S802HA3.0	3.00	0.08	6.00	4.00	50.0	2
S802HA3.5	3.50	0.08	6.00	4.00	50.0	2
S802HA4.0	4.00	0.13	6.00	5.00	54.0	2
S802HA4.5	4.50	0.13	6.00	5.00	54.0	2
S802HA5.0	5.00	0.13	6.00	6.00	54.0	2
S802HA6.0	6.00	0.13	6.00	7.00	54.0	2
S802HA7.0	7.00	0.13	8.00	8.00	58.0	2
S802HA8.0	8.00	0.20	8.00	9.00	58.0	2
S802HA9.0	9.00	0.20	10.00	10.00	66.0	2
S802HA10.0	10.00	0.20	10.00	11.00	66.0	2
S802HA12.0	12.00	0.20	12.00	12.00	73.0	2
S802HA14.0	14.00	0.20	14.00	14.00	75.0	2
S802HA16.0	16.00	0.20	16.00	16.00	82.0	2
S802HA18.0	18.00	0.20	18.00	18.00	84.0	2
S802HA20.0	20.00	0.30	20.00	20.00	92.0	2

S802HB

DORMER



Fresa de Metal Duro de 2 Filos para Ranurado, Mango HB DIN 6535

Fresa con longitud de corte extra corta de 2 filos que proporciona alta rigidez para fresado de ranuras poco profundas con tolerancia P9 y operaciones de fresado en rampa. El mango Weldon evita que la fresa se deslice en el portaherramientas. El recubrimiento AlCrN mejora el rendimiento y alarga la vida de la herramienta.

HM	N	NOF 2
	λ 28°	γ 9°
DIN 6535HB	AlCrN	
DIN 6527K		

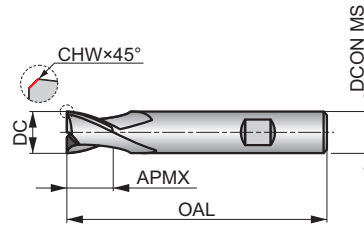

Grupo de Material de la pieza adecuado. Valores de inicio de la velocidad de corte (m/min) y código alfabético. Las tablas con avances por diente y factores de corrección en la pag. 266.

P1.1 ■ 206 K	P1.2 ■ 230 K	P1.3 ■ 238 K	P2.1 ■ 176 K	P2.2 ■ 155 K	P2.3 ■ 137 J	P3.1 ■ 143 K	P3.2 ■ 114 J	P3.3 ■ 97 J	P4.1 ■ 84 J	P4.2 ■ 72 J	P4.3 ■ 58 J	M1.1 ■ 121 K	M1.2 ■ 102 K
M2.1 ■ 107 K	M2.2 ■ 89 J	M2.3 ▣ 75 J	M3.1 ■ 99 J	M3.2 ■ 85 J	M3.3 ▣ 76 J	M4.1 ▣ 75 J	M4.2 ▣ 63 J	K1.1 ■ 205 K	K1.2 ■ 152 K	K1.3 ■ 114 K	K2.1 ■ 210 K	K2.2 ■ 171 K	K2.3 ■ 137 J
K3.1 ■ 186 K	K3.2 ■ 143 K	K3.3 ■ 115 J	K4.1 ■ 173 J	K4.2 ■ 131 J	K4.3 ■ 95 J	K4.4 ■ 82 J	K4.5 ■ 68 J	K5.1 ■ 196 J	K5.2 ■ 147 J	K5.3 ■ 114 J	N1.1 ▣ 408 K	N1.2 ▣ 307 K	N1.3 ■ 206 K
N2.1 ■ 206 K	N2.2 ■ 184 K	N2.3 ■ 132 K	N3.1 ■ 215 K	N3.2 ■ 125 K	N3.3 ▣ 64 K	N4.1 ▣ 215 K	N4.2 ▣ 83 K	S1.1 ▣ 81 J	S1.2 ▣ 71 J	S2.1 ▣ 55 J	S3.1 ▣ 41 J	S4.1 ▣ 32 J	

DCON MS tolerancia h6; DC ≤ 7.75 mm: CHW ±0.03×45° mm; DC > 7.75 mm: CHW ±0.05×45° mm.

Product	DC (mm)	CHW (mm)	DCON MS (mm)	APMX (mm)	OAL (mm)	NOF
S802HB2.0	2.00	—	6.00	3.00	50.0	2
S802HB2.5	2.50	0.08	6.00	3.00	50.0	2
S802HB3.0	3.00	0.08	6.00	4.00	50.0	2
S802HB3.5	3.50	0.08	6.00	4.00	50.0	2
S802HB4.0	4.00	0.13	6.00	5.00	54.0	2
S802HB4.5	4.50	0.13	6.00	5.00	54.0	2
S802HB5.0	5.00	0.13	6.00	6.00	54.0	2
S802HB6.0	6.00	0.13	6.00	7.00	54.0	2
S802HB7.0	7.00	0.13	8.00	8.00	58.0	2
S802HB8.0	8.00	0.20	8.00	9.00	58.0	2
S802HB9.0	9.00	0.20	10.00	10.00	66.0	2
S802HB10.0	10.00	0.20	10.00	11.00	66.0	2
S802HB12.0	12.00	0.20	12.00	12.00	73.0	2
S802HB14.0	14.00	0.20	14.00	14.00	75.0	2
S802HB16.0	16.00	0.20	16.00	16.00	82.0	2
S802HB18.0	18.00	0.20	18.00	18.00	84.0	2
S802HB20.0	20.00	0.30	20.00	20.00	92.0	2

S812HA

DORMER



Fresa de Metal Duro de 2 Filos para Ranurado, Mango HA DIN 6535

Fresa con longitud de corte corta de 2 filos, que proporciona alta rigidez en el fresado de ranuras estándar con tolerancia P9 y operaciones de fresado en rampa. El recubrimiento AlCrN aumenta la vida de la herramienta y mejora el rendimiento.

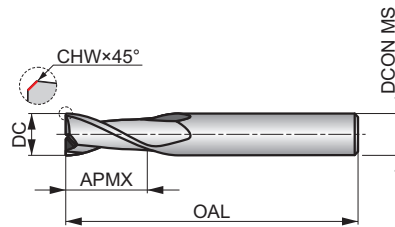

HM	N	NOF 2
	λ 28°	γ 9°
DIN 6535HA	AlCrN	
DIN 6527L		



Grupo de Material de la pieza adecuado. Valores de inicio de la velocidad de corte (m/min) y código alfabético. Las tablas con avances por diente y factores de corrección en la pag. 266.

P1.1 ■ 166 K	P1.2 ■ 186 K	P1.3 ■ 192 K	P2.1 ■ 142 K	P2.2 ■ 125 K	P2.3 ■ 111 J	P3.1 ■ 115 K	P3.2 ■ 93 J	P3.3 ■ 78 J	P4.1 ■ 68 J	P4.2 ■ 59 J	P4.3 ■ 47 J	M1.1 ■ 97 K	M1.2 ■ 81 K
M2.1 ■ 85 K	M2.2 ■ 71 J	M3.1 ■ 79 J	M3.2 ■ 68 J	M3.3 ■ 61 J	M4.1 ■ 60 J	K1.1 ■ 166 K	K1.2 ■ 123 K	K1.3 ■ 92 K	K2.1 ■ 170 K	K2.2 ■ 138 K	K2.3 ■ 110 J	K3.1 ■ 150 K	K3.2 ■ 115 K
K3.3 ■ 93 J	K4.1 ■ 140 J	K4.2 ■ 105 J	K4.3 ■ 77 J	K4.4 ■ 66 J	K4.5 ■ 56 J	K5.1 ■ 159 J	K5.2 ■ 118 J	K5.3 ■ 92 J	N1.1 ■ 330 K	N1.2 ■ 247 K	N1.3 ■ 166 K	N2.1 ■ 166 K	N2.2 ■ 148 K
N2.3 ■ 107 K	N3.1 ■ 173 K	N3.2 ■ 101 K	N3.3 ■ 52 K	N4.1 ■ 173 K	N4.2 ■ 67 K	S1.1 ■ 72 J	S1.2 ■ 64 J	S2.1 ■ 49 J	S3.1 ■ 38 J	S4.1 ■ 30 J			

DCON MS tolerancia h6; DC ≤ 7.00 mm: CHW ±0.03×45° mm; DC > 7.00 mm: CHW ±0.05×45° mm.

Product	DC (mm)	CHW (mm)	DCON MS (mm)	APMX (mm)	OAL (mm)	NOF
S812HA2.0	2.00	—	6.00	6.00	57.0	2
S812HA2.5	2.50	0.08	6.00	7.00	57.0	2
S812HA3.0	3.00	0.08	6.00	7.00	57.0	2
S812HA3.5	3.50	0.08	6.00	7.00	57.0	2
S812HA4.0	4.00	0.13	6.00	8.00	57.0	2
S812HA4.5	4.50	0.13	6.00	8.00	57.0	2
S812HA5.0	5.00	0.13	6.00	10.00	57.0	2
S812HA6.0	6.00	0.13	6.00	10.00	57.0	2
S812HA7.0	7.00	0.13	8.00	13.00	63.0	2
S812HA8.0	8.00	0.20	8.00	16.00	63.0	2
S812HA9.0	9.00	0.20	10.00	16.00	72.0	2
S812HA10.0	10.00	0.20	10.00	19.00	72.0	2
S812HA12.0	12.00	0.20	12.00	22.00	83.0	2
S812HA14.0	14.00	0.20	14.00	22.00	83.0	2
S812HA16.0	16.00	0.20	16.00	26.00	92.0	2
S812HA18.0	18.00	0.20	18.00	26.00	92.0	2
S812HA20.0	20.00	0.30	20.00	32.00	104.0	2

S812HB

DORMER



Fresa de Metal Duro de 2 Filos para Ranurado, Mango HB DIN 6535

Fresa con longitud de corte corta de 2 filos, que proporciona alta rigidez en el fresado de ranuras estándar con tolerancia P9 y operaciones de fresado en rampa. El mango Weldon evita que la fresa se deslice en el portaherramientas. El recubrimiento AlCrN aumenta la vida de la herramienta y mejora el rendimiento.

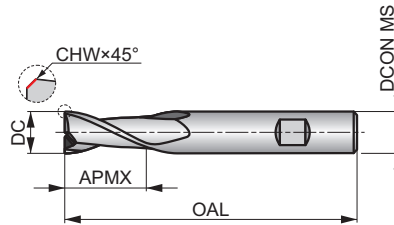

HM	N	NOF 2
	λ 28°	γ 9°
DIN 6535HB	AlCrN	
DIN 6527L		



Grupo de Material de la pieza adecuado. Valores de inicio de la velocidad de corte (m/min) y código alfabético. Las tablas con avances por diente y factores de corrección en la pag. 266.

P1.1 ■ 166 K	P1.2 ■ 186 K	P1.3 ■ 192 K	P2.1 ■ 142 K	P2.2 ■ 125 K	P2.3 ■ 111 J	P3.1 ■ 115 K	P3.2 ■ 93 J	P3.3 ■ 78 J	P4.1 ■ 68 J	P4.2 ■ 59 J	P4.3 ■ 47 J	M1.1 ■ 97 K	M1.2 ■ 81 K
M2.1 ■ 85 K	M2.2 ■ 71 J	M3.1 ■ 79 J	M3.2 ■ 68 J	M3.3 ■ 61 J	M4.1 ■ 60 J	K1.1 ■ 166 K	K1.2 ■ 123 K	K1.3 ■ 92 K	K2.1 ■ 170 K	K2.2 ■ 138 K	K2.3 ■ 110 J	K3.1 ■ 150 K	K3.2 ■ 115 K
K3.3 ■ 93 J	K4.1 ■ 140 J	K4.2 ■ 105 J	K4.3 ■ 77 J	K4.4 ■ 66 J	K4.5 ■ 56 J	K5.1 ■ 159 J	K5.2 ■ 118 J	K5.3 ■ 92 J	N1.1 ■ 330 K	N1.2 ■ 247 K	N1.3 ■ 166 K	N2.1 ■ 166 K	N2.2 ■ 148 K
N2.3 ■ 107 K	N3.1 ■ 173 K	N3.2 ■ 101 K	N3.3 ■ 52 K	N4.1 ■ 173 K	N4.2 ■ 67 K	S1.1 ■ 72 J	S1.2 ■ 64 J	S2.1 ■ 49 J	S3.1 ■ 38 J	S4.1 ■ 30 J			

DCON MS tolerancia h6; DC ≤ 7.00 mm: CHW ±0.03×45° mm; DC > 7.00 mm: CHW ±0.05×45° mm.

Product	DC (mm)	CHW (mm)	DCON MS (mm)	APMX (mm)	OAL (mm)	NOF
S812HB2.0	2.00	0.00	6.00	6.00	57.0	2
S812HB2.5	2.50	0.08	6.00	7.00	57.0	2
S812HB3.0	3.00	0.08	6.00	7.00	57.0	2
S812HB3.5	3.50	0.08	6.00	7.00	57.0	2
S812HB4.0	4.00	0.13	6.00	8.00	57.0	2
S812HB4.5	4.50	0.13	6.00	8.00	57.0	2
S812HB5.0	5.00	0.13	6.00	10.00	57.0	2
S812HB6.0	6.00	0.13	6.00	10.00	57.0	2
S812HB7.0	7.00	0.13	8.00	13.00	63.0	2
S812HB8.0	8.00	0.20	8.00	16.00	63.0	2
S812HB9.0	9.00	0.20	10.00	16.00	72.0	2
S812HB10.0	10.00	0.20	10.00	19.00	72.0	2
S812HB12.0	12.00	0.20	12.00	22.00	83.0	2
S812HB14.0	14.00	0.20	14.00	22.00	83.0	2
S812HB16.0	16.00	0.20	16.00	26.00	92.0	2
S812HB18.0	18.00	0.20	18.00	26.00	92.0	2
S812HB20.0	20.00	0.30	20.00	32.00	104.0	2

S710



Fresa de Metal Duro de 2 Filos

Fresa con longitud de corte corta de 2 filos con hélice de 40°, que proporciona alta rigidez en el fresado de ranuras estándar. El recubrimiento AlCrN aumenta la vida de la herramienta y mejora el rendimiento.

HM	N	NOF 2
	λ 40°	γ 10°
DIN 6535HA	AlCrN	DC h9
	DORMER	

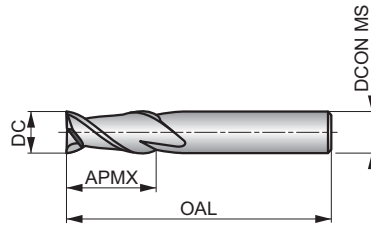

Grupo de Material de la pieza adecuado. Valores de inicio de la velocidad de corte (m/min) y código alfabético. Las tablas con avances por diente y factores de corrección en la pag. 266.

P1.1 ■ 199 K	P1.2 ■ 223 K	P1.3 ■ 230 K	P2.1 ■ 170 K	P2.2 ■ 150 K	P2.3 ■ 133 J	P3.1 ■ 138 K	P3.2 ■ 111 J	P3.3 ■ 94 J	P4.1 ■ 82 J	P4.2 ■ 70 J	M1.1 ■ 115 K	M1.2 ■ 97 K	M2.1 ■ 102 K
M2.2 ■ 84 J	M3.1 ■ 94 J	M3.2 ■ 81 J	K1.1 ■ 196 K	K1.2 ■ 145 K	K1.3 ■ 109 K	K2.1 ■ 202 K	K2.2 ■ 164 K	K2.3 ■ 131 J	K3.1 ■ 178 K	K3.2 ■ 136 K	K3.3 ■ 110 J	K4.1 ■ 165 J	K4.2 ■ 125 J
K4.3 ■ 91 J	K4.4 ■ 78 J	K4.5 ■ 65 J	K5.1 ■ 187 J	K5.2 ■ 141 J	K5.3 ■ 109 J	S1.2 ■ 69 J	S2.1 ■ 53 J	S3.1 ■ 40 J	S4.1 ■ 31 J				

DCON MS tolerancia h6.

Product	DC (mm)	DCON MS (mm)	APMX (mm)	OAL (mm)	NOF
S7101.0	1.00	3.00	3.00	40.0	2
S7101.5	1.50	3.00	4.50	40.0	2
S7102.0	2.00	3.00	6.50	40.0	2
S7102.5	2.50	3.00	6.50	40.0	2
S7103.0	3.00	6.00	9.00	50.0	2
S7104.0	4.00	6.00	12.00	50.0	2
S7105.0	5.00	6.00	15.00	50.0	2
S7106.0	6.00	6.00	20.00	60.0	2
S7108.0	8.00	8.00	20.00	64.0	2
S71010.0	10.00	10.00	22.00	75.0	2
S71012.0	12.00	12.00	25.00	75.0	2
S71016.0	16.00	16.00	32.00	90.0	2
S71020.0	20.00	20.00	38.00	100.0	2

S822



Fresa de Metal Duro de 2 Filos para Ranurado

Fresa con longitud de corte media de 2 filos que proporciona alta rigidez en el fresado de ranuras estándar con tolerancia P9 y operaciones de fresado en rampa. El recubrimiento AlCrN aumenta la vida de la herramienta y mejora el rendimiento.

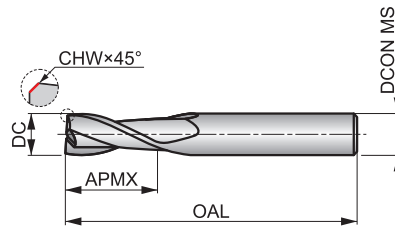

HM	N	NOF 2
	λ 28°	γ 9°
DIN 6535HA	AlCrN	
DORMER		



Grupo de Material de la pieza adecuado. Valores de inicio de la velocidad de corte (m/min) y código alfabético. Las tablas con avances por diente y factores de corrección en la pag. 266.

P1.1 ■ 146 K	P1.2 ■ 164 K	P1.3 ■ 169 K	P2.1 ■ 125 K	P2.2 ■ 110 K	P2.3 ■ 98 J	P3.1 ■ 101 K	P3.2 ■ 82 J	P3.3 ■ 69 J	P4.1 ■ 61 J	P4.2 ■ 52 J	P4.3 ■ 41 J	M1.1 ■ 85 K	M1.2 ■ 72 K
M2.1 ■ 76 K	M2.2 ■ 62 J	M3.1 ■ 70 J	M3.2 ■ 60 J	M3.3 ■ 54 J	M4.1 ■ 53 J	K1.1 ■ 145 K	K1.2 ■ 108 K	K1.3 ■ 81 K	K2.1 ■ 150 K	K2.2 ■ 122 K	K2.3 ■ 97 J	K3.1 ■ 133 K	K3.2 ■ 102 K
K3.3 ■ 82 J	K4.1 ■ 123 J	K4.2 ■ 93 J	K4.3 ■ 68 J	K4.4 ■ 59 J	K4.5 ■ 48 J	K5.1 ■ 139 J	K5.2 ■ 105 J	K5.3 ■ 81 J	N1.1 ■ 287 K	N1.2 ■ 216 K	N1.3 ■ 144 K	N2.1 ■ 144 K	N2.2 ■ 129 K
N2.3 ■ 93 K	N3.1 ■ 152 K	N3.2 ■ 88 K	N3.3 ■ 45 K	N4.1 ■ 152 K	N4.2 ■ 59 K	S1.1 ■ 58 J	S1.2 ■ 51 J	S2.1 ■ 39 J	S3.1 ■ 29 J	S4.1 ■ 23 J			

DCON MS tolerancia h6; DC ≤ 7.00 mm: CHW ±0.03×45° mm; DC > 7.00 mm: CHW ±0.05×45° mm.

Product	DC (mm)	CHW (mm)	DCON MS (mm)	APMX (mm)	OAL (mm)	NOF
S8222.0	2.00	—	6.00	8.00	57.0	2
S8222.5	2.50	0.08	6.00	12.00	57.0	2
S8223.0	3.00	0.08	6.00	12.00	57.0	2
S8224.0	4.00	0.13	6.00	14.00	57.0	2
S8225.0	5.00	0.13	6.00	16.00	57.0	2
S8226.0	6.00	0.13	6.00	19.00	57.0	2
S8227.0	7.00	0.13	8.00	19.00	63.0	2
S8228.0	8.00	0.20	8.00	19.00	63.0	2
S8229.0	9.00	0.20	10.00	21.00	72.0	2
S82210.0	10.00	0.20	10.00	22.00	72.0	2
S82212.0	12.00	0.20	12.00	25.00	83.0	2
S82214.0	14.00	0.20	14.00	30.00	83.0	2
S82216.0	16.00	0.20	16.00	32.00	92.0	2
S82218.0	18.00	0.20	18.00	32.00	92.0	2
S82220.0	20.00	0.30	20.00	38.00	104.0	2

S803HA

DORMER



Fresa de Metal Duro de 3 Filos para Ranurado, Mango HA DIN 6535

Fresa con longitud de corte extra corta de 3 filos que proporciona alta rigidez y es adecuada para fresado de ranuras poco profundas con tolerancia P9. El recubrimiento AlCrN aumenta la vida de la herramienta y mejora el rendimiento. Adecuada también para fresado en rampa y fresado axial (plunge).

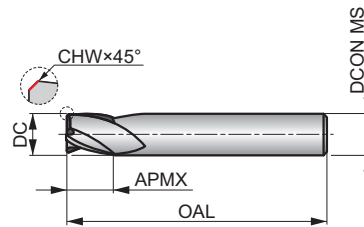

HM	N	NOF 3
	λ 28°	γ 9°
DIN 6535HA	AlCrN	
DIN 6527K		



Grupo de Material de la pieza adecuado. Valores de inicio de la velocidad de corte (m/min) y código alfabético. Las tablas con avances por diente y factores de corrección en la pag. 266.

P1.1 ■ 206 J	P1.2 ■ 230 J	P1.3 ■ 238 J	P2.1 ■ 176 J	P2.2 ■ 155 J	P2.3 ■ 137 I	P3.1 ■ 143 J	P3.2 ■ 114 I	P3.3 ■ 97 I	P4.1 ■ 84 I	P4.2 ■ 72 I	P4.3 ■ 58 I	M1.1 ■ 121 J	M1.2 ■ 102 J
M2.1 ■ 107 J	M2.2 ■ 89 I	M2.3 ■ 75 I	M3.1 ■ 99 I	M3.2 ■ 85 I	M3.3 ■ 76 I	M4.1 ■ 75 I	M4.2 ■ 63 I	K1.1 ■ 205 J	K1.2 ■ 152 J	K1.3 ■ 114 J	K2.1 ■ 210 J	K2.2 ■ 171 J	K2.3 ■ 137 I
K3.1 ■ 186 J	K3.2 ■ 143 J	K3.3 ■ 115 I	K4.1 ■ 173 I	K4.2 ■ 131 I	K4.3 ■ 95 I	K4.4 ■ 82 I	K4.5 ■ 68 I	K5.1 ■ 196 I	K5.2 ■ 147 I	K5.3 ■ 114 I	N1.1 ■ 408 K	N1.2 ■ 307 K	N1.3 ■ 206 K
N2.1 ■ 206 J	N2.2 ■ 184 J	N2.3 ■ 132 J	N3.1 ■ 215 J	N3.2 ■ 125 J	N3.3 ■ 64 J	N4.1 ■ 215 J	N4.2 ■ 183 J	S1.1 ■ 81 I	S1.2 ■ 71 I	S2.1 ■ 55 I	S3.1 ■ 41 I	S4.1 ■ 32 I	

DCON MS tolerancia h6; DC ≤ 7.75 mm: CHW ±0.03×45° mm; DC > 7.75 mm: CHW ±0.05×45° mm.

Product	DC (mm)	CHW (mm)	DCON MS (mm)	APMX (mm)	OAL (mm)	NOF
S803HA1.0	1.00	—	3.00	3.00	38.0	3
S803HA1.5	1.50	—	3.00	3.00	38.0	3
S803HA2.0	2.00	—	6.00	3.00	50.0	3
S803HA2.5	2.50	0.08	6.00	3.00	50.0	3
S803HA2.8	2.80	0.08	6.00	4.00	50.0	3
S803HA3.0	3.00	0.08	6.00	4.00	50.0	3
S803HA3.5	3.50	0.08	6.00	4.00	50.0	3
S803HA3.8	3.80	0.08	6.00	5.00	54.0	3
S803HA4.0	4.00	0.13	6.00	5.00	54.0	3
S803HA4.5	4.50	0.13	6.00	5.00	54.0	3
S803HA4.8	4.80	0.13	6.00	6.00	54.0	3
S803HA5.0	5.00	0.13	6.00	6.00	54.0	3
S803HA6.0	6.00	0.13	6.00	7.00	54.0	3
S803HA7.0	7.00	0.13	8.00	8.00	58.0	3
S803HA8.0	8.00	0.20	8.00	9.00	58.0	3
S803HA9.0	9.00	0.20	10.00	10.00	66.0	3
S803HA10.0	10.00	0.20	10.00	11.00	66.0	3
S803HA12.0	12.00	0.20	12.00	12.00	73.0	3
S803HA14.0	14.00	0.20	14.00	14.00	75.0	3
S803HA16.0	16.00	0.20	16.00	16.00	82.0	3
S803HA18.0	18.00	0.20	18.00	18.00	84.0	3
S803HA20.0	20.00	0.30	20.00	20.00	92.0	3

S803HB



Fresa de Metal Duro de 3 Filos para Ranurado, Mango HB DIN 6535

Fresa con longitud de corte extra corta de 3 filos que proporciona alta rigidez y es adecuada para fresado de ranuras poco profundas con tolerancia P9. El recubrimiento AlCrN aumenta la vida de la herramienta y mejora el rendimiento. Adecuada también para fresado en rampa y fresado axial (plunge).

HM	N	NOF 3
	λ 28°	γ 9°
DIN 6535HB	AlCrN	
DIN 6527K		

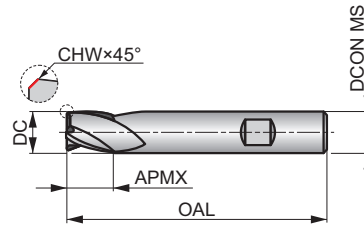

Grupo de Material de la pieza adecuado. Valores de inicio de la velocidad de corte (m/min) y código alfabético. Las tablas con avances por diente y factores de corrección en la pag. 266.

P1.1 ■ 206 J	P1.2 ■ 230 J	P1.3 ■ 238 J	P2.1 ■ 176 J	P2.2 ■ 155 J	P2.3 ■ 137 I	P3.1 ■ 143 J	P3.2 ■ 114 I	P3.3 ■ 97 I	P4.1 ■ 84 I	P4.2 ■ 72 I	P4.3 ■ 58 I	M1.1 ■ 121 J	M1.2 ■ 102 J
M2.1 ■ 107 J	M2.2 ■ 89 I	M2.3 ■ 75 I	M3.1 ■ 99 I	M3.2 ■ 85 I	M3.3 ■ 76 I	M4.1 ■ 75 I	M4.2 ■ 63 I	K1.1 ■ 205 J	K1.2 ■ 152 J	K1.3 ■ 114 J	K2.1 ■ 210 J	K2.2 ■ 171 J	K2.3 ■ 137 I
K3.1 ■ 186 J	K3.2 ■ 143 J	K3.3 ■ 115 I	K4.1 ■ 173 I	K4.2 ■ 131 I	K4.3 ■ 95 I	K4.4 ■ 82 I	K4.5 ■ 68 I	K5.1 ■ 196 I	K5.2 ■ 147 I	K5.3 ■ 114 I	N1.1 ■ 408 K	N1.2 ■ 307 K	N1.3 ■ 206 K
N2.1 ■ 206 J	N2.2 ■ 184 J	N2.3 ■ 132 J	N3.1 ■ 215 J	N3.2 ■ 125 J	N3.3 ■ 64 J	N4.1 ■ 215 J	N4.2 ■ 183 J	S1.1 ■ 81 I	S1.2 ■ 71 I	S2.1 ■ 55 I	S3.1 ■ 41 I	S4.1 ■ 32 I	

DCON MS tolerancia h6; DC ≤ 7.75 mm: CHW ±0.03×45° mm; DC > 7.75 mm: CHW ±0.05×45° mm.

Product	DC (mm)	CHW (mm)	DCON MS (mm)	APMX (mm)	OAL (mm)	NOF
S803HB2.0	2.00	—	6.00	3.00	50.0	3
S803HB2.5	2.50	0.08	6.00	3.00	50.0	3
S803HB2.8	2.80	0.08	6.00	4.00	50.0	3
S803HB3.0	3.00	0.08	6.00	4.00	50.0	3
S803HB3.5	3.50	0.08	6.00	4.00	50.0	3
S803HB3.8	3.80	0.08	6.00	5.00	54.0	3
S803HB4.0	4.00	0.13	6.00	5.00	54.0	3
S803HB4.5	4.50	0.13	6.00	5.00	54.0	3
S803HB4.8	4.80	0.13	6.00	6.00	54.0	3
S803HB5.0	5.00	0.13	6.00	6.00	54.0	3
S803HB5.75	5.75	0.13	6.00	7.00	54.0	3
S803HB6.0	6.00	0.13	6.00	7.00	54.0	3
S803HB6.75	6.75	0.13	8.00	8.00	58.0	3
S803HB7.0	7.00	0.13	8.00	8.00	58.0	3
S803HB7.75	7.75	0.13	8.00	9.00	58.0	3
S803HB8.0	8.00	0.20	8.00	9.00	58.0	3
S803HB9.0	9.00	0.20	10.00	10.00	66.0	3
S803HB9.7	9.70	0.20	10.00	11.00	66.0	3
S803HB10.0	10.00	0.20	10.00	11.00	66.0	3
S803HB11.7	11.70	0.20	12.00	12.00	73.0	3
S803HB12.0	12.00	0.20	12.00	12.00	73.0	3
S803HB14.0	14.00	0.20	14.00	14.00	75.0	3
S803HB16.0	16.00	0.20	16.00	16.00	82.0	3
S803HB18.0	18.00	0.20	18.00	18.00	84.0	3
S803HB20.0	20.00	0.30	20.00	20.00	92.0	3

S813HA

DORMER



Fresa de Metal Duro de 3 Filos para Ranurado, Mango HA DIN 6535

Fresa con longitud de corte corta de 3 filos, que proporciona alta rigidez en el fresado de ranuras estándar con tolerancia P9. El recubrimiento AlCrN aumenta la vida de la herramienta y mejora el rendimiento. Adecuada también para fresado axial (plunge) y fresado en rampa.

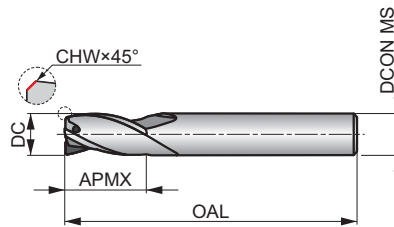

HM	N	NOF 3
	λ 28°	γ 9°
DIN 6535HA	AlCrN	
DIN 6527L		



Grupo de Material de la pieza adecuado. Valores de inicio de la velocidad de corte (m/min) y código alfabético. Las tablas con avances por diente y factores de corrección en la pag. 266.

P1.1 ■ 166 J	P1.2 ■ 186 J	P1.3 ■ 192 J	P2.1 ■ 142 J	P2.2 ■ 125 J	P2.3 ■ 111 I	P3.1 ■ 115 J	P3.2 ■ 93 I	P3.3 ■ 78 I	P4.1 ■ 68 I	P4.2 ■ 59 I	P4.3 ▣ 47 I	M1.1 ■ 97 J	M1.2 ■ 81 J
M2.1 ■ 85 J	M2.2 ■ 71 I	M3.1 ▣ 79 I	M3.2 ▣ 68 I	M3.3 ▣ 61 I	M4.1 ▣ 60 I	K1.1 ■ 166 J	K1.2 ■ 123 J	K1.3 ■ 92 J	K2.1 ■ 170 J	K2.2 ■ 138 J	K2.3 ■ 110 I	K3.1 ■ 150 J	K3.2 ■ 115 J
K3.3 ■ 93 I	K4.1 ■ 140 I	K4.2 ■ 105 I	K4.3 ■ 77 I	K4.4 ■ 66 I	K4.5 ■ 56 I	K5.1 ■ 159 I	K5.2 ■ 118 I	K5.3 ■ 92 I	N1.1 ▣ 330 K	N1.2 ▣ 247 K	N1.3 ■ 166 K	N2.1 ■ 166 J	N2.2 ■ 148 J
N2.3 ■ 107 J	N3.1 ■ 173 J	N3.2 ■ 101 J	N3.3 ▣ 52 J	N4.1 ▣ 173 J	N4.2 ▣ 67 J	S1.1 ▣ 72 I	S1.2 ▣ 64 I	S2.1 ▣ 49 I	S3.1 ▣ 38 I	S4.1 ▣ 30 I			

DCON MS tolerancia h6; DC ≤ 7.00 mm: CHW ±0.03×45° mm; DC > 7.00 mm: CHW ±0.05×45° mm.

Product	DC (mm)	CHW (mm)	DCON MS (mm)	APMX (mm)	OAL (mm)	NOF
S813HA2.0	2.00	0.00	6.00	6.00	57.0	3
S813HA2.5	2.50	0.08	6.00	7.00	57.0	3
S813HA3.0	3.00	0.08	6.00	7.00	57.0	3
S813HA3.5	3.50	0.08	6.00	7.00	57.0	3
S813HA4.0	4.00	0.13	6.00	8.00	57.0	3
S813HA4.5	4.50	0.13	6.00	8.00	57.0	3
S813HA5.0	5.00	0.13	6.00	10.00	57.0	3
S813HA6.0	6.00	0.13	6.00	10.00	57.0	3
S813HA7.0	7.00	0.13	8.00	13.00	63.0	3
S813HA8.0	8.00	0.20	8.00	16.00	63.0	3
S813HA9.0	9.00	0.20	10.00	16.00	72.0	3
S813HA10.0	10.00	0.20	10.00	19.00	72.0	3
S813HA12.0	12.00	0.20	12.00	22.00	83.0	3
S813HA14.0	14.00	0.20	14.00	22.00	83.0	3
S813HA16.0	16.00	0.20	16.00	26.00	92.0	3
S813HA18.0	18.00	0.20	18.00	26.00	92.0	3
S813HA20.0	20.00	0.30	20.00	32.00	104.0	3

S813HB

DORMER

Fresa de Metal Duro de 3 Filos para Ranurado, Mango HB DIN 6535

Fresa con longitud de corte corta de 3 filos, que proporciona alta rigidez en el fresado de ranuras estándar con tolerancia P9. El mango Weldon evita que la fresa se deslice en el portaherramientas. El recubrimiento AlCrN aumenta la vida de la herramienta y mejora el rendimiento. Adecuada también para fresado en rampa y fresado axial (plunge).

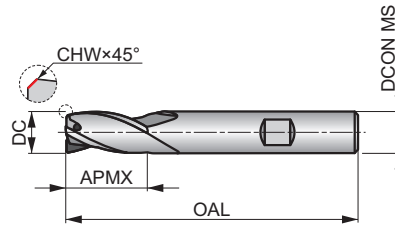

HM	N	NOF 3
	λ 28°	γ 9°
DIN 6535HB	AlCrN	
DIN 6527L		



Grupo de Material de la pieza adecuado. Valores de inicio de la velocidad de corte (m/min) y código alfabético. Las tablas con avances por diente y factores de corrección en la pag. 266.

P1.1 ■ 166 J	P1.2 ■ 186 J	P1.3 ■ 192 J	P2.1 ■ 142 J	P2.2 ■ 125 J	P2.3 ■ 111 I	P3.1 ■ 115 J	P3.2 ■ 93 I	P3.3 ■ 78 I	P4.1 ■ 68 I	P4.2 ■ 59 I	P4.3 ▣ 47 I	M1.1 ■ 97 J	M1.2 ■ 81 J
M2.1 ■ 85 J	M2.2 ■ 71 I	M3.1 ▣ 79 I	M3.2 ▣ 68 I	M3.3 ▣ 61 I	M4.1 ▣ 60 I	K1.1 ■ 166 J	K1.2 ■ 123 J	K1.3 ■ 92 J	K2.1 ■ 170 J	K2.2 ■ 138 J	K2.3 ■ 110 I	K3.1 ■ 150 J	K3.2 ■ 115 J
K3.3 ■ 93 I	K4.1 ■ 140 I	K4.2 ■ 105 I	K4.3 ■ 77 I	K4.4 ■ 66 I	K4.5 ■ 56 I	K5.1 ■ 159 I	K5.2 ■ 118 I	K5.3 ■ 92 I	N1.1 ▣ 330 K	N1.2 ▣ 247 K	N1.3 ■ 166 K	N2.1 ■ 166 J	N2.2 ■ 148 J
N2.3 ■ 107 J	N3.1 ■ 173 J	N3.2 ■ 101 J	N3.3 ▣ 52 J	N4.1 ▣ 173 J	N4.2 ▣ 67 J	S1.1 ▣ 72 I	S1.2 ▣ 64 I	S2.1 ▣ 49 I	S3.1 ▣ 38 I	S4.1 ▣ 30 I			

DCON MS tolerancia h6; DC ≤ 7.00 mm: CHW ±0.03×45° mm; DC > 7.00 mm: CHW ±0.05×45° mm.

Product	DC (mm)	CHW (mm)	DCON MS (mm)	APMX (mm)	OAL (mm)	NOF
S813HB2.0	2.00	0.00	6.00	6.00	57.0	3
S813HB2.5	2.50	0.08	6.00	7.00	57.0	3
S813HB3.0	3.00	0.08	6.00	7.00	57.0	3
S813HB3.5	3.50	0.08	6.00	7.00	57.0	3
S813HB4.0	4.00	0.13	6.00	8.00	57.0	3
S813HB4.5	4.50	0.13	6.00	8.00	57.0	3
S813HB5.0	5.00	0.13	6.00	10.00	57.0	3
S813HB6.0	6.00	0.13	6.00	10.00	57.0	3
S813HB7.0	7.00	0.13	8.00	13.00	63.0	3
S813HB8.0	8.00	0.20	8.00	16.00	63.0	3
S813HB9.0	9.00	0.20	10.00	16.00	72.0	3
S813HB10.0	10.00	0.20	10.00	19.00	72.0	3
S813HB12.0	12.00	0.20	12.00	22.00	83.0	3
S813HB14.0	14.00	0.20	14.00	22.00	83.0	3
S813HB16.0	16.00	0.20	16.00	26.00	92.0	3
S813HB18.0	18.00	0.20	18.00	26.00	92.0	3
S813HB20.0	20.00	0.30	20.00	32.00	104.0	3

S713

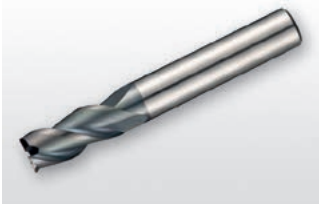

Fresa de Metal Duro de 3 Filos

Fresa con longitud de corte corta de 3 filos con hélice de 40° que proporciona alta rigidez en el fresado de ranuras estándar. El recubrimiento AlCrN aumenta la vida de la herramienta y mejora el rendimiento.

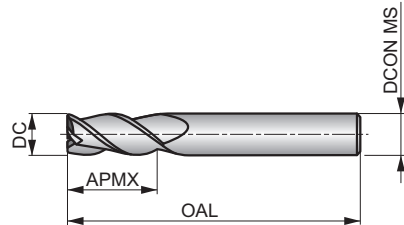

HM	N	NOF 3
	λ 40°	γ 10°
DIN 6535HA	AlCrN	DC h9

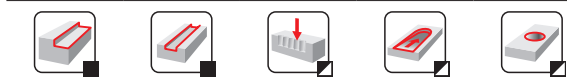

Grupo de Material de la pieza adecuado. Valores de inicio de la velocidad de corte (m/min) y código alfabético. Las tablas con avances por diente y factores de corrección en la pag. 266.

P1.1 ■ 199 J	P1.2 ■ 223 J	P1.3 ■ 230 J	P2.1 ■ 170 J	P2.2 ■ 150 J	P2.3 ■ 133 I	P3.1 ■ 138 J	P3.2 ■ 111 I	P3.3 ■ 94 I	P4.1 ■ 82 I	P4.2 ■ 70 I	M1.1 ■ 115 J	M1.2 ■ 97 J	M2.1 ■ 102 J
M2.2 ■ 84 I	M3.1 ■ 94 I	M3.2 ■ 81 I	K1.1 ■ 196 J	K1.2 ■ 145 J	K1.3 ■ 109 J	K2.1 ■ 202 J	K2.2 ■ 164 J	K2.3 ■ 131 I	K3.1 ■ 178 J	K3.2 ■ 136 J	K3.3 ■ 110 I	K4.1 ■ 165 I	K4.2 ■ 125 I
K4.3 ■ 91 I	K4.4 ■ 78 I	K4.5 ■ 65 I	K5.1 ■ 187 I	K5.2 ■ 141 I	K5.3 ■ 109 I	S1.2 ■ 69 I	S2.1 ■ 53 I	S3.1 ■ 40 I	S4.1 ■ 31 I				

DCON MS tolerancia h6.

Product	DC (mm)	DCON MS (mm)	APMX (mm)	OAL (mm)	NOF
S7131.5	1.50	4.00	4.50	40.0	3
S7132.0	2.00	4.00	6.50	40.0	3
S7133.0	3.00	3.00	9.00	40.0	3
S7134.0	4.00	4.00	12.00	50.0	3
S7135.0	5.00	5.00	15.00	50.0	3
S7136.0	6.00	6.00	16.00	50.0	3
S7138.0	8.00	8.00	20.00	64.0	3
S71310.0	10.00	10.00	22.00	70.0	3
S71312.0	12.00	12.00	25.00	75.0	3
S71314.0	14.00	14.00	32.00	90.0	3
S71316.0	16.00	16.00	32.00	90.0	3
S71318.0	18.00	18.00	38.00	100.0	3
S71320.0	20.00	20.00	38.00	100.0	3

S823

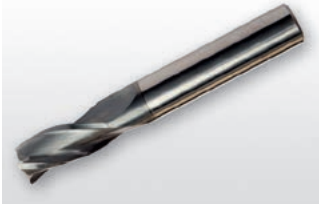

Fresa de Metal Duro de 3 Filos para Ranurado

Fresa con longitud de corte media de 3 fillos que proporciona alta rigidez en el fresado de ranuras estándar con tolerancia P9 y operaciones de fresado en rampa. El recubrimiento AlCrN aumenta la vida de la herramienta y mejora el rendimiento.

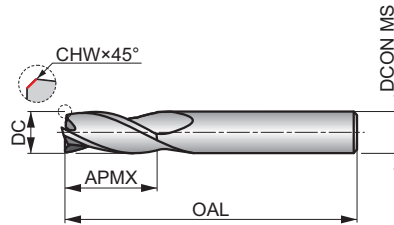

HM	N	NOF 3
	λ 28°	γ 9°
DIN 6535HA	AlCrN	
DORMER		



Grupo de Material de la pieza adecuado. Valores de inicio de la velocidad de corte (m/min) y código alfabético. Las tablas con avances por diente y factores de corrección en la pag. 266.

P1.1 ■ 145 J	P1.2 ■ 162 J	P1.3 ■ 167 J	P2.1 ■ 124 J	P2.2 ■ 109 J	P2.3 ■ 97 I	P3.1 ■ 100 J	P3.2 ■ 81 I	P3.3 ■ 68 I	P4.1 ■ 60 I	P4.2 ■ 51 I	P4.3 ▣ 41 I	M1.1 ■ 84 J	M1.2 ■ 71 J
M2.1 ■ 75 J	M2.2 ■ 61 I	M3.1 ▣ 69 I	M3.2 ▣ 59 I	M3.3 ▣ 53 I	M4.1 ▣ 52 I	K1.1 ■ 144 J	K1.2 ■ 107 J	K1.3 ■ 80 J	K2.1 ■ 149 J	K2.2 ■ 121 J	K2.3 ■ 96 I	K3.1 ■ 132 J	K3.2 ■ 101 J
K3.3 ■ 81 I	K4.1 ■ 122 I	K4.2 ■ 92 I	K4.3 ■ 67 I	K4.4 ■ 58 I	K4.5 ■ 48 I	K5.1 ■ 138 I	K5.2 ■ 104 I	K5.3 ■ 80 I	N1.1 ▣ 284 K	N1.2 ▣ 214 K	N1.3 ■ 143 K	N2.1 ■ 143 J	N2.2 ■ 128 J
N2.3 ■ 92 J	N3.1 ■ 150 J	N3.2 ■ 87 J	N3.3 ▣ 45 J	N4.1 ▣ 150 J	N4.2 ▣ 58 J	S1.1 ▣ 113 I	S1.2 ▣ 100 I	S2.1 ▣ 77 I	S3.1 ▣ 58 I	S4.1 ▣ 45 I			

DCON MS tolerancia h6; DC ≤ 7.00 mm: CHW ±0.03×45° mm; DC > 7.00 mm: CHW ±0.05×45° mm.

Product	DC (mm)	CHW (mm)	DCON MS (mm)	APMX (mm)	OAL (mm)	NOF
S8232.0	2.00	—	6.00	8.00	57.0	3
S8232.5	2.50	0.08	6.00	12.00	57.0	3
S8233.0	3.00	0.08	6.00	12.00	57.0	3
S8234.0	4.00	0.13	6.00	14.00	57.0	3
S8235.0	5.00	0.13	6.00	16.00	57.0	3
S8236.0	6.00	0.13	6.00	19.00	57.0	3
S8237.0	7.00	0.13	8.00	19.00	63.0	3
S8238.0	8.00	0.20	8.00	19.00	63.0	3
S8239.0	9.00	0.20	10.00	21.00	72.0	3
S82310.0	10.00	0.20	10.00	22.00	72.0	3
S82312.0	12.00	0.20	12.00	25.00	83.0	3
S82314.0	14.00	0.20	14.00	30.00	83.0	3
S82316.0	16.00	0.20	16.00	32.00	92.0	3
S82318.0	18.00	0.20	18.00	32.00	92.0	3
S82320.0	20.00	0.30	20.00	38.00	104.0	3

S714



Fresa de Metal Duro de 3 Filos, Serie Larga

Fresa con longitud de corte larga de 3 filos con hélice a 40° que proporciona alta rigidez para el perfilado de paredes profundas. El recubrimiento AlCrN aumenta la vida de la herramienta y mejora el rendimiento.

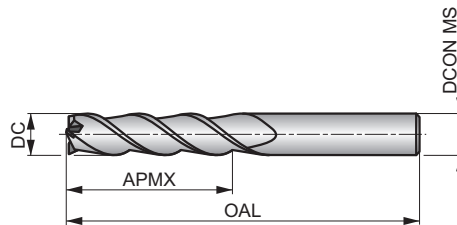

HM	N	NOF 3
	λ 40°	γ 10°
DIN 6335HA	AlCrN	DC h9



Grupo de Material de la pieza adecuado. Valores de inicio de la velocidad de corte (m/min) y código alfabético. Las tablas con avances por diente y factores de corrección en la pag. 266.

P1.1 ■ 140 J	P1.2 ■ 157 J	P1.3 ■ 162 J	P2.1 ■ 120 J	P2.2 ■ 106 J	P2.3 ■ 94 I	P3.1 ■ 97 J	P3.2 ■ 78 I	P3.3 ■ 66 I	P4.1 ■ 58 I	P4.2 ■ 49 I	M1.1 ■ 81 J	M1.2 ■ 68 J	M2.1 ■ 71 J
M2.2 ■ 59 I	M3.1 ■ 66 I	M3.2 ■ 57 I	K1.1 ■ 138 J	K1.2 ■ 102 J	K1.3 ■ 77 J	K2.1 ■ 142 J	K2.2 ■ 115 J	K2.3 ■ 92 I	K3.1 ■ 125 J	K3.2 ■ 96 J	K3.3 ■ 78 I	K4.1 ■ 116 I	K4.2 ■ 88 I
K4.3 ■ 64 I	K4.4 ■ 55 I	K4.5 ■ 46 I	K5.1 ■ 132 I	K5.2 ■ 99 I	K5.3 ■ 77 I	N1.1 ▣ 249 K	N1.2 ▣ 187 K	N1.3 ▣ 125 K	N2.1 ▣ 125 J	N2.2 ▣ 112 J	N2.3 ▣ 81 J	N3.1 ▣ 131 J	N3.2 ▣ 76 J
N3.3 ▣ 39 J	S1.2 ■ 49 I	S2.1 ■ 37 I	S3.1 ■ 28 I	S4.1 ■ 22 I									

DCON MS tolerancia h6.

Product	DC (mm)	DCON MS (mm)	APMX (mm)	OAL (mm)	NOF
S7143.0	3.00	3.00	19.00	60.0	3
S7144.0	4.00	4.00	19.00	60.0	3
S7145.0	5.00	5.00	19.00	60.0	3
S7146.0	6.00	6.00	31.00	75.0	3
S7148.0	8.00	8.00	31.00	75.0	3
S71410.0	10.00	10.00	31.00	75.0	3
S71412.0	12.00	12.00	50.00	100.0	3
S71414.0	14.00	14.00	57.00	125.0	3
S71416.0	16.00	16.00	57.00	125.0	3
S71418.0	18.00	18.00	57.00	125.0	3
S71420.0	20.00	20.00	57.00	125.0	3

S715



Fresa de Metal Duro de 3 Filos, Serie Extra Larga

Fresa con longitud de corte extra larga de 3 filos, con ángulo de hélice de 40°, que proporciona alta rigidez en aplicaciones de perfilado de paredes muy profundas. El recubrimiento AlCrN mejora el rendimiento y alarga la vida de la herramienta.

HM	N	NOF 3
	λ 40°	γ 10°
DIN 6535HA	AlCrN	DC h9

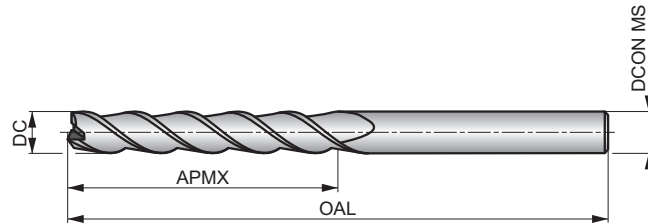

Grupo de Material de la pieza adecuado. Valores de inicio de la velocidad de corte (m/min) y código alfabético. Las tablas con avances por diente y factores de corrección en la pag. 266.

P1.1 ■ 88 J	P1.2 ■ 98 J	P1.3 ■ 101 J	P2.1 ■ 75 J	P2.2 ■ 66 J	P2.3 ■ 59 I	P3.1 ■ 61 J	P3.2 ■ 49 I	P3.3 ■ 41 I	P4.1 ■ 36 I	P4.2 ■ 31 I	M1.1 ■ 50 J	M1.2 ■ 42 J	M2.1 ■ 44 J
M2.2 ■ 36 I	M3.1 ■ 41 I	M3.2 ■ 35 I	K1.1 ■ 86 J	K1.2 ■ 64 J	K1.3 ■ 48 J	K2.1 ■ 89 J	K2.2 ■ 72 J	K2.3 ■ 58 I	K3.1 ■ 79 J	K3.2 ■ 60 J	K3.3 ■ 49 I	K4.1 ■ 73 I	K4.2 ■ 55 I
K4.3 ■ 40 I	K4.4 ■ 35 I	K4.5 ■ 29 I	K5.1 ■ 83 I	K5.2 ■ 62 I	K5.3 ■ 48 I	N1.1 ▣ 178 K	N1.2 ▣ 134 K	N1.3 ▣ 190 K	N2.1 ▣ 190 J	N2.2 ▣ 180 J	N2.3 ▣ 158 J	N3.1 ▣ 94 J	N3.2 ▣ 155 J
N3.3 ▣ 28 J	S1.2 ■ 30 I	S2.1 ■ 23 I	S3.1 ■ 18 I	S4.1 ■ 14 I									

DCON MS tolerancia h6.

Product	DC (mm)	DCON MS (mm)	APMX (mm)	OAL (mm)	NOF
S7153.0	3.00	3.00	25.00	100.0	3
S7154.0	4.00	4.00	31.00	100.0	3
S7155.0	5.00	5.00	31.00	100.0	3
S7156.0	6.00	6.00	38.00	100.0	3
S7158.0	8.00	8.00	41.00	100.0	3
S71510.0	10.00	10.00	57.00	125.0	3
S71512.0	12.00	12.00	75.00	150.0	3
S71514.0	14.00	14.00	75.00	150.0	3
S71516.0	16.00	16.00	75.00	150.0	3
S71518.0	18.00	18.00	75.00	150.0	3
S71520.0	20.00	20.00	75.00	150.0	3

Código de Material (BMC)	HM	HM	HM	HM	HM	HM	HM											
Perfil de la fresa	N	N	N	N	N	N	N											
Número de canales (NOF)	NOF 4	NOF 4	NOF 4	NOF 4	NOF 4	NOF 4	NOF 4											
Longitud de corte																		
Ángulo de hélice (FHA)	λ 34°	λ 34°	λ 34°	λ 34°	λ 40°	λ 40°	λ 40°											
Ángulo de hélice (FHA)	λ 34°	λ 34°	λ 34°	λ 34°	λ 40°	λ 40°	λ 40°											
Ángulo de incidencia radial (GAMF)	γ 9°	γ 9°	γ 9°	γ 9°	γ 10°	γ 10°	γ 10°											
Mango																		
Recubrimiento	AICN	AICN	AICN	AICN	AICN	AICN	AICN											
Clase de tolerancia del diámetro de corte (TCDC)	DC h10	DC h10	DC h10	DC h10	DC h9	DC h9	DC h9											
Dirección																		
Grupo básico estándar (BSG)	DIN 6527K	DIN 6527K	DIN 6527L	DIN 6527L	DORMER	DORMER	DORMER											
Código de Familia de Producto	S804HA	S804HB	S814HA	S814HB	S716	S717	S718											
Gama de diámetros de corte PSF	2.00 – 25.00	2.00 – 25.00	2.00 – 25.00	2.00 – 25.00	2.00 – 20.00	3.00 – 20.00	3.00 – 20.00											
P	P1	■	■	■	■	■	■											
	P2	■	■	■	■	■	■											
	P3	■	■	■	■	■	■											
	P4	■	■	■	■	■	■											
M	M1	■	■	■	■	■	■											
	M2	■	■	■	■	■	■											
	M3	■	■	▣	▣	■	■	■										
	M4	▣	▣	▣	▣	■	■	■										
K	K1	■	■	■	■	■	■											
	K2	■	■	■	■	■	■											
	K3	■	■	■	■	■	■											
	K4	■	■	■	■	■	■											
	K5	■	■	■	■	■	■											
N	N1	▣	▣	▣	▣		▣	▣										
	N2	▣	▣	▣	▣		▣	▣										
	N3	■	■	■	■		▣	▣										
	N4	▣	▣	▣	▣		▣	▣										
	N5																	
S	S1	▣	▣	▣	▣	■	■	■										
	S2	▣	▣	▣	▣	■	■	■										
	S3	▣	▣	▣	▣	■	■	■										
	S4	▣	▣	▣	▣	■	■	■										
H	H1																	
	H2																	
	H3																	
	H4																	

S804HA

DORMER



Fresa de Metal Duro de 4 Filos, Mango HA DIN 6535

Fresa con longitud de corte extra corta de 4 filos, que proporciona alta rigidez en operaciones de perfilado poco profundo y fresado axial (plunge). El recubrimiento AlCrN aumenta la vida de la herramienta y mejora el rendimiento.

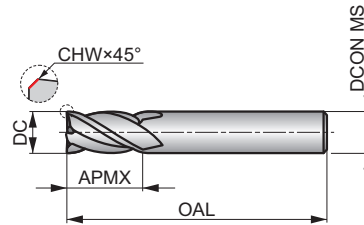

HM	N	NOF 4
	λ 34°	γ 9°
DIN 6535HA	AlCrN	DC h10
	DIN 6527K	



Grupo de Material de la pieza adecuado. Valores de inicio de la velocidad de corte (m/min) y código alfabético. Las tablas con avances por diente y factores de corrección en la pag. 266.

P1.1 ■ 206 J	P1.2 ■ 230 J	P1.3 ■ 238 J	P2.1 ■ 176 J	P2.2 ■ 155 J	P2.3 ■ 137 I	P3.1 ■ 143 J	P3.2 ■ 114 I	P3.3 ■ 97 I	P4.1 ■ 84 I	P4.2 ■ 72 I	P4.3 ■ 58 I	M1.1 ■ 121 J	M1.2 ■ 102 J
M2.1 ■ 107 J	M2.2 ■ 89 I	M2.3 ■ 75 I	M3.1 ■ 99 I	M3.2 ■ 85 I	M3.3 ■ 76 I	M4.1 ■ 75 I	M4.2 ■ 63 I	K1.1 ■ 205 J	K1.2 ■ 152 J	K1.3 ■ 114 J	K2.1 ■ 210 J	K2.2 ■ 171 J	K2.3 ■ 137 I
K3.1 ■ 186 J	K3.2 ■ 143 J	K3.3 ■ 115 I	K4.1 ■ 173 I	K4.2 ■ 131 I	K4.3 ■ 95 I	K4.4 ■ 82 I	K4.5 ■ 68 I	K5.1 ■ 196 I	K5.2 ■ 147 I	K5.3 ■ 114 I	N1.1 ■ 408 J	N1.2 ■ 307 J	N1.3 ■ 206 J
N2.1 ■ 206 J	N2.2 ■ 184 J	N2.3 ■ 132 J	N3.1 ■ 215 J	N3.2 ■ 125 J	N3.3 ■ 64 J	N4.1 ■ 215 J	N4.2 ■ 183 J	S1.1 ■ 81 I	S1.2 ■ 71 I	S2.1 ■ 55 I	S3.1 ■ 41 I	S4.1 ■ 32 I	

DCON MS tolerancia h6; DC ≤ 8.00 mm: CHW ±0.03×45° mm; DC > 8.00 mm: CHW ±0.05×45° mm.

Product	DC (mm)	CHW (mm)	DCON MS (mm)	APMX (mm)	OAL (mm)	NOF
S804HA2.0	2.00	—	6.00	4.00	50.0	4
S804HA3.0	3.00	0.08	6.00	5.00	50.0	4
S804HA4.0	4.00	0.13	6.00	8.00	54.0	4
S804HA5.0	5.00	0.13	6.00	9.00	54.0	4
S804HA6.0	6.00	0.13	6.00	10.00	54.0	4
S804HA8.0	8.00	0.13	8.00	12.00	58.0	4
S804HA10.0	10.00	0.20	10.00	14.00	66.0	4
S804HA12.0	12.00	0.20	12.00	16.00	73.0	4
S804HA16.0	16.00	0.20	16.00	22.00	82.0	4
S804HA20.0	20.00	0.30	20.00	26.00	92.0	4
S804HA25.0	25.00	0.30	25.00	32.00	121.0	4

S804HB

DORMER



Fresa de Metal Duro de 4 Filos, Mango HB DIN 6535

Fresa con longitud de corte extra corta de 4 filos, que proporciona alta rigidez en operaciones de perfilado poco profundo y fresado axial (plunge). El mango Weldon evita que la fresa se deslice en el portaherramientas. El recubrimiento AlCrN aumenta la vida de la herramienta y mejora el rendimiento.

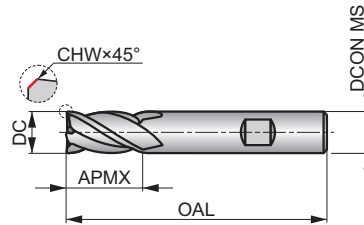

HM	N	NOF 4
	λ 34°	γ 9°
DIN 6535HB	AlCrN	DC h10
	DIN 6527K	



Grupo de Material de la pieza adecuado. Valores de inicio de la velocidad de corte (m/min) y código alfabético. Las tablas con avances por diente y factores de corrección en la pag. 266.

P1.1 ■ 206 J	P1.2 ■ 230 J	P1.3 ■ 238 J	P2.1 ■ 176 J	P2.2 ■ 155 J	P2.3 ■ 137 I	P3.1 ■ 143 J	P3.2 ■ 114 I	P3.3 ■ 97 I	P4.1 ■ 84 I	P4.2 ■ 72 I	P4.3 ■ 58 I	M1.1 ■ 121 J	M1.2 ■ 102 J
M2.1 ■ 107 J	M2.2 ■ 89 I	M2.3 ■ 75 I	M3.1 ■ 99 I	M3.2 ■ 85 I	M3.3 ■ 76 I	M4.1 ■ 75 I	M4.2 ■ 63 I	K1.1 ■ 205 J	K1.2 ■ 152 J	K1.3 ■ 114 J	K2.1 ■ 210 J	K2.2 ■ 171 J	K2.3 ■ 137 I
K3.1 ■ 186 J	K3.2 ■ 143 J	K3.3 ■ 115 I	K4.1 ■ 173 I	K4.2 ■ 131 I	K4.3 ■ 95 I	K4.4 ■ 82 I	K4.5 ■ 68 I	K5.1 ■ 196 I	K5.2 ■ 147 I	K5.3 ■ 114 I	N1.1 ■ 408 J	N1.2 ■ 307 J	N1.3 ■ 206 J
N2.1 ■ 206 J	N2.2 ■ 184 J	N2.3 ■ 132 J	N3.1 ■ 215 J	N3.2 ■ 125 J	N3.3 ■ 64 J	N4.1 ■ 215 J	N4.2 ■ 183 J	S1.1 ■ 81 I	S1.2 ■ 71 I	S2.1 ■ 55 I	S3.1 ■ 41 I	S4.1 ■ 32 I	

DCON MS tolerancia h6; DC ≤ 8.00 mm: CHW ±0.03×45° mm; DC > 8.00 mm: CHW ±0.05×45° mm.

Product	DC (mm)	CHW (mm)	DCON MS (mm)	APMX (mm)	OAL (mm)	NOF
S804HB2.0	2.00	—	6.00	4.00	50.0	4
S804HB3.0	3.00	0.08	6.00	5.00	50.0	4
S804HB4.0	4.00	0.13	6.00	8.00	54.0	4
S804HB5.0	5.00	0.13	6.00	9.00	54.0	4
S804HB6.0	6.00	0.13	6.00	10.00	54.0	4
S804HB8.0	8.00	0.13	8.00	12.00	58.0	4
S804HB10.0	10.00	0.20	10.00	14.00	66.0	4
S804HB12.0	12.00	0.20	12.00	16.00	73.0	4
S804HB16.0	16.00	0.20	16.00	22.00	82.0	4
S804HB20.0	20.00	0.30	20.00	26.00	92.0	4
S804HB25.0	25.00	0.30	25.00	32.00	121.0	4

S814HA

DORMER



Fresa de Metal Duro de 4 Filos, Mango HA DIN 6535

Fresa con longitud de corte corta de 4 filos, que proporciona alta rigidez en aplicaciones de perfilado general y fresado axial (plunge). El recubrimiento AlCrN aumenta la vida de la herramienta y mejora el rendimiento.

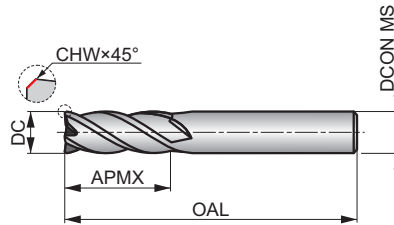

HM	N	NOF 4
	λ 34°	γ 9°
DIN 6535HA	AlCrN	
DIN 6527L	DC h10	



Grupo de Material de la pieza adecuado. Valores de inicio de la velocidad de corte (m/min) y código alfabético. Las tablas con avances por diente y factores de corrección en la pag. 266.

P1.1 ■ 166 J	P1.2 ■ 186 J	P1.3 ■ 192 J	P2.1 ■ 142 J	P2.2 ■ 125 J	P2.3 ■ 111 I	P3.1 ■ 115 J	P3.2 ■ 93 I	P3.3 ■ 78 I	P4.1 ■ 68 I	P4.2 ■ 59 I	P4.3 ▣ 47 I	M1.1 ■ 97 J	M1.2 ■ 81 J
M2.1 ■ 85 J	M2.2 ■ 71 I	M3.1 ▣ 79 I	M3.2 ▣ 68 I	M3.3 ▣ 61 I	M4.1 ▣ 60 I	K1.1 ■ 166 J	K1.2 ■ 123 J	K1.3 ■ 92 J	K2.1 ■ 170 J	K2.2 ■ 138 J	K2.3 ■ 110 I	K3.1 ■ 150 J	K3.2 ■ 115 J
K3.3 ■ 93 I	K4.1 ■ 140 I	K4.2 ■ 105 I	K4.3 ■ 77 I	K4.4 ■ 66 I	K4.5 ■ 56 I	K5.1 ■ 159 I	K5.2 ■ 118 I	K5.3 ■ 92 I	N1.1 ▣ 330 J	N1.2 ▣ 247 J	N1.3 ▣ 166 J	N2.1 ▣ 166 J	N2.2 ▣ 148 J
N2.3 ▣ 107 J	N3.1 ■ 173 J	N3.2 ■ 101 J	N3.3 ▣ 52 J	N4.1 ▣ 173 J	N4.2 ▣ 67 J	S1.1 ▣ 72 I	S1.2 ▣ 64 I	S2.1 ▣ 49 I	S3.1 ▣ 38 I	S4.1 ▣ 30 I			

DCON MS tolerancia h6; DC ≤ 8.00 mm: CHW ±0.03×45° mm; DC > 8.00 mm: CHW ±0.05×45° mm.

Product	DC (mm)	CHW (mm)	DCON MS (mm)	APMX (mm)	OAL (mm)	NOF
S814HA2.0	2.00	0.00	6.00	7.00	57.0	4
S814HA3.0	3.00	0.08	6.00	8.00	57.0	4
S814HA4.0	4.00	0.13	6.00	11.00	57.0	4
S814HA5.0	5.00	0.13	6.00	13.00	57.0	4
S814HA6.0	6.00	0.13	6.00	13.00	57.0	4
S814HA8.0	8.00	0.13	8.00	19.00	63.0	4
S814HA10.0	10.00	0.20	10.00	22.00	72.0	4
S814HA12.0	12.00	0.20	12.00	26.00	83.0	4
S814HA16.0	16.00	0.20	16.00	32.00	92.0	4
S814HA20.0	20.00	0.30	20.00	38.00	104.0	4
S814HA25.0	25.00	0.30	25.00	45.00	121.0	4

S814HB

DORMER



Fresa de Metal Duro de 4 Filos, Mango HB DIN 6535

Fresa con longitud de corte corta de 4 filos, que proporciona alta rigidez en aplicaciones de perfilado general y fresado axial (plunge). El mango Weldon evita que la fresa se deslice en el portaherramientas. El recubrimiento AlCrN aumenta la vida de la herramienta y mejora el rendimiento.

HM	N	NOF 4
	λ 34°	γ 9°
DIN 6535HB	AlCrN	DC h10
	DIN 6527L	

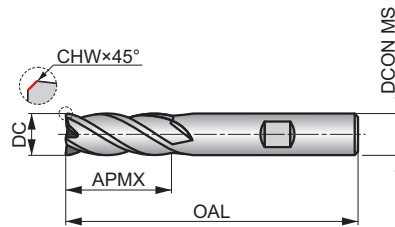

Grupo de Material de la pieza adecuado. Valores de inicio de la velocidad de corte (m/min) y código alfabético. Las tablas con avances por diente y factores de corrección en la pag. 266.

P1.1 ■ 166 J	P1.2 ■ 186 J	P1.3 ■ 192 J	P2.1 ■ 142 J	P2.2 ■ 125 J	P2.3 ■ 111 I	P3.1 ■ 115 J	P3.2 ■ 93 I	P3.3 ■ 78 I	P4.1 ■ 68 I	P4.2 ■ 59 I	P4.3 ▣ 47 I	M1.1 ■ 97 J	M1.2 ■ 81 J
M2.1 ■ 85 J	M2.2 ■ 71 I	M3.1 ▣ 79 I	M3.2 ▣ 68 I	M3.3 ▣ 61 I	M4.1 ▣ 60 I	K1.1 ■ 166 J	K1.2 ■ 123 J	K1.3 ■ 92 J	K2.1 ■ 170 J	K2.2 ■ 138 J	K2.3 ■ 110 I	K3.1 ■ 150 J	K3.2 ■ 115 J
K3.3 ■ 93 I	K4.1 ■ 140 I	K4.2 ■ 105 I	K4.3 ■ 77 I	K4.4 ■ 66 I	K4.5 ■ 56 I	K5.1 ■ 159 I	K5.2 ■ 118 I	K5.3 ■ 92 I	N1.1 ▣ 330 J	N1.2 ▣ 247 J	N1.3 ▣ 166 J	N2.1 ▣ 166 J	N2.2 ▣ 148 J
N2.3 ▣ 107 J	N3.1 ■ 173 J	N3.2 ■ 101 J	N3.3 ▣ 52 J	N4.1 ▣ 173 J	N4.2 ▣ 67 J	S1.1 ▣ 72 I	S1.2 ▣ 64 I	S2.1 ▣ 49 I	S3.1 ▣ 38 I	S4.1 ▣ 30 I			

DCON MS tolerancia h6; DC ≤ 8.00 mm: CHW ±0.03×45° mm; DC > 8.00 mm: CHW ±0.05×45° mm.

Product	DC (mm)	CHW (mm)	DCON MS (mm)	APMX (mm)	OAL (mm)	NOF
S814HB2.0	2.00	0.00	6.00	7.00	57.0	4
S814HB3.0	3.00	0.08	6.00	8.00	57.0	4
S814HB4.0	4.00	0.13	6.00	11.00	57.0	4
S814HB5.0	5.00	0.13	6.00	13.00	57.0	4
S814HB6.0	6.00	0.13	6.00	13.00	57.0	4
S814HB8.0	8.00	0.13	8.00	19.00	63.0	4
S814HB10.0	10.00	0.20	10.00	22.00	72.0	4
S814HB12.0	12.00	0.20	12.00	26.00	83.0	4
S814HB16.0	16.00	0.20	16.00	32.00	92.0	4
S814HB20.0	20.00	0.30	20.00	38.00	104.0	4
S814HB25.0	25.00	0.30	25.00	45.00	121.0	4

S716



Fresa de Metal Duro de 4 Filos

Fresa con longitud de corte corta de 4 filos, con hélice a 40° que proporciona alta rigidez en operaciones de perfilado estándar. El recubrimiento AlCrN mejora el rendimiento y aumenta la vida de la herramienta.

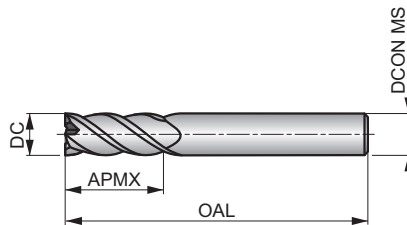

HM	N	NOF 4
	λ 40°	γ 10°
DIN 6535HA	AlCrN	DC h9
	DORMER	



Grupo de Material de la pieza adecuado. Valores de inicio de la velocidad de corte (m/min) y código alfabético. Las tablas con avances por diente y factores de corrección en la pag. 266.

P1.1 ■ 199 J	P1.2 ■ 223 J	P1.3 ■ 230 J	P2.1 ■ 170 J	P2.2 ■ 150 J	P2.3 ■ 133 I	P3.1 ■ 138 J	P3.2 ■ 111 I	P3.3 ■ 94 I	P4.1 ■ 82 I	P4.2 ■ 70 I	M1.1 ■ 115 J	M1.2 ■ 97 J	M2.1 ■ 102 J
M2.2 ■ 84 I	M3.1 ■ 94 I	M3.2 ■ 81 I	K1.1 ■ 196 J	K1.2 ■ 145 J	K1.3 ■ 109 J	K2.1 ■ 202 J	K2.2 ■ 164 J	K2.3 ■ 131 I	K3.1 ■ 178 J	K3.2 ■ 136 J	K3.3 ■ 110 I	K4.1 ■ 165 I	K4.2 ■ 125 I
K4.3 ■ 91 I	K4.4 ■ 78 I	K4.5 ■ 65 I	K5.1 ■ 187 I	K5.2 ■ 141 I	K5.3 ■ 109 I	S1.2 ■ 69 I	S2.1 ■ 53 I	S3.1 ■ 40 I	S4.1 ■ 31 I				

DCON MS tolerancia h6.

Product	DC (mm)	DCON MS (mm)	APMX (mm)	OAL (mm)	NOF
S7162.0	2.00	4.00	6.50	40.0	4
S7163.0	3.00	3.00	9.00	40.0	4
S7164.0	4.00	4.00	12.00	50.0	4
S7165.0	5.00	5.00	15.00	50.0	4
S7166.0	6.00	6.00	16.00	50.0	4
S7168.0	8.00	8.00	20.00	64.0	4
S71610.0	10.00	10.00	22.00	70.0	4
S71612.0	12.00	12.00	25.00	75.0	4
S71614.0	14.00	14.00	32.00	90.0	4
S71616.0	16.00	16.00	32.00	90.0	4
S71618.0	18.00	18.00	38.00	100.0	4
S71620.0	20.00	20.00	38.00	100.0	4

S717



Fresa de Metal Duro de 4 Filos, Serie Larga

Fresa con longitud de corte larga de 4 filos con hélice a 40°, que proporciona alta rigidez en aplicaciones de perfilado en paredes profundas. El recubrimiento AlCrN aumenta la vida de la herramienta y mejora el rendimiento.

HM	N	NOF 4
	λ 40°	γ 10°
DIN 6535HA	AlCrN	DC h9

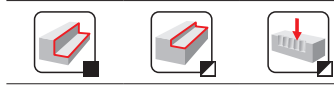
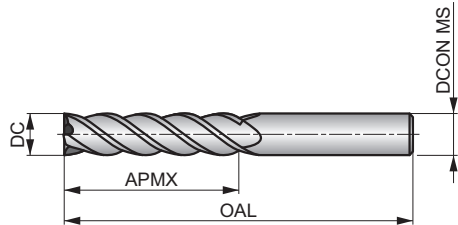

Grupo de Material de la pieza adecuado. Valores de inicio de la velocidad de corte (m/min) y código alfabético. Las tablas con avances por diente y factores de corrección en la pag. 266.

P1.1 ■ 140 J	P1.2 ■ 157 J	P1.3 ■ 162 J	P2.1 ■ 120 J	P2.2 ■ 106 J	P2.3 ■ 94 I	P3.1 ■ 97 J	P3.2 ■ 78 I	P3.3 ■ 66 I	P4.1 ■ 58 I	P4.2 ■ 49 I	M1.1 ■ 81 J	M1.2 ■ 68 J	M2.1 ■ 71 J
M2.2 ■ 59 I	M3.1 ■ 66 I	M3.2 ■ 57 I	K1.1 ■ 138 J	K1.2 ■ 102 J	K1.3 ■ 77 J	K2.1 ■ 142 J	K2.2 ■ 115 J	K2.3 ■ 92 I	K3.1 ■ 125 J	K3.2 ■ 96 J	K3.3 ■ 78 I	K4.1 ■ 116 I	K4.2 ■ 88 I
K4.3 ■ 64 I	K4.4 ■ 55 I	K4.5 ■ 46 I	K5.1 ■ 132 I	K5.2 ■ 99 I	K5.3 ■ 77 I	N1.1 ▣ 249 K	N1.2 ▣ 187 K	N1.3 ▣ 125 K	N2.1 ▣ 125 J	N2.2 ▣ 112 J	N2.3 ▣ 81 J	N3.1 ▣ 131 J	N3.2 ▣ 176 J
N3.3 ▣ 39 J	S1.2 ■ 49 I	S2.1 ■ 37 I	S3.1 ■ 28 I	S4.1 ■ 22 I									

DCON MS tolerancia h6.

Product	DC (mm)	DCON MS (mm)	APMX (mm)	OAL (mm)	NOF
S7173.0	3.00	3.00	19.00	60.0	4
S7174.0	4.00	4.00	19.00	60.0	4
S7175.0	5.00	5.00	19.00	60.0	4
S7176.0	6.00	6.00	31.00	75.0	4
S7178.0	8.00	8.00	31.00	75.0	4
S71710.0	10.00	10.00	31.00	75.0	4
S71712.0	12.00	12.00	50.00	100.0	4
S71714.0	14.00	14.00	57.00	125.0	4
S71716.0	16.00	16.00	57.00	125.0	4
S71718.0	18.00	18.00	57.00	125.0	4
S71720.0	20.00	20.00	57.00	125.0	4

S718



Fresa de Metal Duro de 4 Filos, Serie Extra Larga

Fresa con longitud de corte extra larga de 4 filos, con ángulo de hélice de 40°, que proporciona alta rigidez en aplicaciones de perfilado de paredes muy profundas. El recubrimiento AlCrN mejora el rendimiento y alarga la vida de la herramienta.

HM	N	NOF 4
	λ 40°	γ 10°
DIN 6535HA	AlCrN	DC h9

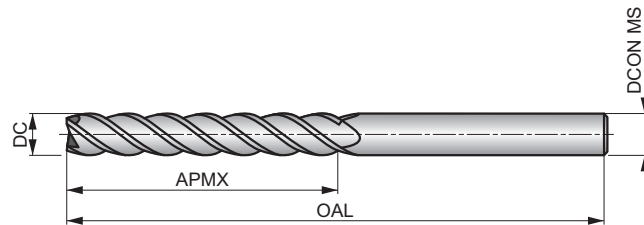

Grupo de Material de la pieza adecuado. Valores de inicio de la velocidad de corte (m/min) y código alfabético. Las tablas con avances por diente y factores de corrección en la pag. 266.

P1.1 ■ 88 J	P1.2 ■ 98 J	P1.3 ■ 101 J	P2.1 ■ 75 J	P2.2 ■ 66 J	P2.3 ■ 59 I	P3.1 ■ 61 J	P3.2 ■ 49 I	P3.3 ■ 41 I	P4.1 ■ 36 I	P4.2 ■ 31 I	M1.1 ■ 50 J	M1.2 ■ 42 J	M2.1 ■ 44 J
M2.2 ■ 36 I	M3.1 ■ 41 I	M3.2 ■ 35 I	K1.1 ■ 86 J	K1.2 ■ 64 J	K1.3 ■ 48 J	K2.1 ■ 89 J	K2.2 ■ 72 J	K2.3 ■ 58 I	K3.1 ■ 79 J	K3.2 ■ 60 J	K3.3 ■ 49 I	K4.1 ■ 73 I	K4.2 ■ 55 I
K4.3 ■ 40 I	K4.4 ■ 35 I	K4.5 ■ 29 I	K5.1 ■ 83 I	K5.2 ■ 62 I	K5.3 ■ 48 I	N1.1 ▣ 178 K	N1.2 ▣ 134 K	N1.3 ▣ 190 K	N2.1 ▣ 190 J	N2.2 ▣ 180 J	N2.3 ▣ 158 J	N3.1 ▣ 194 J	N3.2 ▣ 155 J
N3.3 ▣ 28 J	S1.2 ■ 30 I	S2.1 ■ 23 I	S3.1 ■ 18 I	S4.1 ■ 14 I									

DCON MS tolerancia h6.

Product	DC (mm)	DCON MS (mm)	APMX (mm)	OAL (mm)	NOF
S7183.0	3.00	3.00	25.00	100.0	4
S7184.0	4.00	4.00	31.00	100.0	4
S7185.0	5.00	5.00	31.00	100.0	4
S7186.0	6.00	6.00	38.00	100.0	4
S7188.0	8.00	8.00	41.00	100.0	4
S71810.0	10.00	10.00	57.00	125.0	4
S71812.0	12.00	12.00	75.00	150.0	4
S71814.0	14.00	14.00	75.00	150.0	4
S71816.0	16.00	16.00	75.00	150.0	4
S71818.0	18.00	18.00	75.00	150.0	4
S71820.0	20.00	20.00	75.00	150.0	4



**HERRAMIENTAS DE METAL DURO PARA PROCESOS SEGUROS Y PRODUCTIVIDAD.
UTILIZADAS NORMALMENTE CON CNC Y FABRICACIÓN AUTOMATIZADA.**

Código de Material (BMC)	HM	HM																	
Perfil de la fresa	N	N																	
Número de canales (NOF)	NOF 2	NOF 2																	
Longitud de corte																			
Ángulo de hélice (FHA)	λ 40°	λ 40°																	
Ángulo de hélice (FHA)	λ 40°	λ 40°																	
Ángulo de incidencia radial (GAMF)	γ 10°	γ 10°																	
Mango																			
Recubrimiento	AlTiN	AlTiN																	
Clase de tolerancia del diámetro de corte (TCDC)	DC h9	DC h9																	
Dirección																			
Grupo básico estándar (BSG)	DORMER	DORMER																	



Código de Familia de Producto		S739	S740																
Gama de diámetros de corte PSF		3.00 – 20.00	3.00 – 20.00																
		106	107																
P	P1	■	■																
	P2	■	■																
	P3	■	■																
	P4	■	■																
M	M1	■	■																
	M2	■	■																
	M3	■	■																
	M4																		
K	K1	■	■																
	K2	■	■																
	K3	■	■																
	K4	■	■																
	K5	■	■																
N	N1	■	■																
	N2	■	■																
	N3	■	■																
	N4																		
	N5																		
S	S1	■	■																
	S2	■	■																
	S3	■	■																
	S4	■	■																
H	H1																		
	H2																		
	H3																		
	H4																		

S739

DORMER



Fresa de Metal Duro de 2 Filos para Achaflanado, 60°

Fresa con longitud de corte corta de 2 filos que proporciona alta rigidez y reduce vibraciones. La punta a 60° está diseñada para fresar chaflanes en máquinas CNC. El recubrimiento AlTiN alarga la vida de la herramienta y mejora el rendimiento.

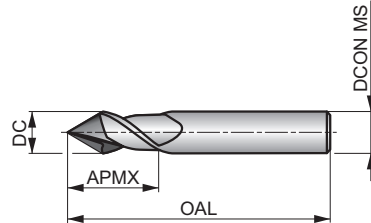

HM	N	NOF 2
	λ 40°	γ 10°
DIN 6535HA	AlTiN	DC h9
	DORMER	



Grupo de Material de la pieza adecuado. Valores de inicio de la velocidad de corte (m/min) y código alfabético. Las tablas con avances por diente y factores de corrección en la pag. 266.

P1.1 ■ 199 K	P1.2 ■ 223 K	P1.3 ■ 230 K	P2.1 ■ 170 K	P2.2 ■ 150 K	P2.3 ■ 133 J	P3.1 ■ 138 K	P3.2 ■ 111 J	P3.3 ■ 94 J	P4.1 ■ 82 J	P4.2 ■ 70 J	M1.1 ■ 115 K	M1.2 ■ 97 K	M2.1 ■ 102 K
M2.2 ■ 84 J	M3.1 ■ 94 J	M3.2 ■ 81 J	K1.1 ■ 196 K	K1.2 ■ 145 K	K1.3 ■ 109 K	K2.1 ■ 202 K	K2.2 ■ 164 K	K2.3 ■ 131 J	K3.1 ■ 178 K	K3.2 ■ 136 K	K3.3 ■ 110 J	K4.1 ■ 165 J	K4.2 ■ 125 J
K4.3 ■ 91 J	K4.4 ■ 78 J	K4.5 ■ 65 J	K5.1 ■ 187 J	K5.2 ■ 141 J	K5.3 ■ 109 J	N1.1 ■ 355 N	N1.2 ■ 267 N	N1.3 ■ 179 N	N2.1 ■ 179 K	N2.2 ■ 160 K	N2.3 ■ 115 K	N3.1 ■ 187 K	N3.2 ■ 109 K
N3.3 ■ 56 K	S1.2 ■ 69 J	S2.1 ■ 53 J	S3.1 ■ 40 J	S4.1 ■ 31 J									

DCON MS tolerancia h6.

Product	KAPR (°)	DC (mm)	DCON MS (mm)	APMX (mm)	OAL (mm)	NOF
S7393.0	60	3.00	3.00	9.00	40.0	2
S7394.0	60	4.00	4.00	12.00	50.0	2
S7395.0	60	5.00	5.00	15.00	50.0	2
S7396.0	60	6.00	6.00	16.00	50.0	2
S7398.0	60	8.00	8.00	20.00	64.0	2
S73910.0	60	10.00	10.00	22.00	70.0	2
S73912.0	60	12.00	12.00	25.00	75.0	2
S73916.0	60	16.00	16.00	32.00	90.0	2
S73920.0	60	20.00	20.00	38.00	100.0	2

S740

DORMER



Fresa de Metal Duro de 2 Filos para Achaflanado, 90°

Fresa con longitud de corte corta de 2 filos que proporciona alta rigidez y reduce vibraciones. La punta a 90° está diseñada para fresar chaflanes en máquinas CNC. El recubrimiento AlTiN alarga la vida de la herramienta y mejora el rendimiento.

HM	N	NOF 2
	λ 40°	γ 10°
DIN 6335HA	AlTiN	DC h9
	DORMER	

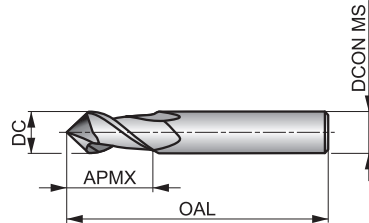

Grupo de Material de la pieza adecuado. Valores de inicio de la velocidad de corte (m/min) y código alfabético. Las tablas con avances por diente y factores de corrección en la pag. 266.

P1.1 ■ 199 K	P1.2 ■ 223 K	P1.3 ■ 230 K	P2.1 ■ 170 K	P2.2 ■ 150 K	P2.3 ■ 133 J	P3.1 ■ 138 K	P3.2 ■ 111 J	P3.3 ■ 94 J	P4.1 ■ 82 J	P4.2 ■ 70 J	M1.1 ■ 115 K	M1.2 ■ 97 K	M2.1 ■ 102 K
M2.2 ■ 84 J	M3.1 ■ 94 J	M3.2 ■ 81 J	K1.1 ■ 196 K	K1.2 ■ 145 K	K1.3 ■ 109 K	K2.1 ■ 202 K	K2.2 ■ 164 K	K2.3 ■ 131 J	K3.1 ■ 178 K	K3.2 ■ 136 K	K3.3 ■ 110 J	K4.1 ■ 165 J	K4.2 ■ 125 J
K4.3 ■ 91 J	K4.4 ■ 78 J	K4.5 ■ 65 J	K5.1 ■ 187 J	K5.2 ■ 141 J	K5.3 ■ 109 J	N1.1 ■ 355 N	N1.2 ■ 267 N	N1.3 ■ 179 N	N2.1 ■ 179 K	N2.2 ■ 160 K	N2.3 ■ 115 K	N3.1 ■ 187 K	N3.2 ■ 109 K
N3.3 ■ 56 K	S1.2 ■ 69 J	S2.1 ■ 53 J	S3.1 ■ 40 J	S4.1 ■ 31 J									

DCON MS tolerancia h6.

Product	KAPR	DC	DCON MS	APMX	OAL	NOF
	(°)	(mm)	(mm)	(mm)	(mm)	
S7403.0	90	3.00	3.00	9.00	40.0	2
S7404.0	90	4.00	4.00	12.00	50.0	2
S7405.0	90	5.00	5.00	15.00	50.0	2
S7406.0	90	6.00	6.00	16.00	50.0	2
S7408.0	90	8.00	8.00	20.00	64.0	2
S74010.0	90	10.00	10.00	22.00	70.0	2
S74012.0	90	12.00	12.00	25.00	75.0	2
S74016.0	90	16.00	16.00	32.00	90.0	2
S74020.0	90	20.00	20.00	38.00	100.0	2

Código de Material (BMC)	HM	HM	HM	HM	HM	HM	HM	HM	HM	HM		
Perfil de la fresa	NRA	NRA	W	W	W	W	W	W	W	N		
Número de canales (NOF)	NOF 4 \neq	NOF 4 \neq	NOF 1	NOF 2	NOF 2	NOF 2	NOF 3 \neq	NOF 3 \neq	NOF 3	NOF 4-6		
Longitud de corte												
Ángulo de hélice (FHA)	λ 40°	λ 40°	λ 25°	λ 30°	λ 30°	λ 30°	λ 40°	λ 40°	λ 40°	λ 25°		
Ángulo de hélice (FHA)	λ 40°	λ 40°	λ 25°	λ 30°	λ 30°	λ 30°	λ 40°	λ 40°	λ 40°	λ 25°		
Ángulo de incidencia radial (GAMF)	γ 10°	γ 10°	γ 20°	γ 20°	γ 20°	γ 20°	γ 13°	γ 15°	γ 13°	γ 0°		
Mango												
Recubrimiento	AlCN	AlCN	Hi	Hi	Hi	Hi	Bright	Bright	Bright	TiSiN		
Clase de tolerancia del diámetro de corte (TCDC)	DC h9	DC h9	DC h9	DC h9	DC h9	DC h9	DC h9	DC h9	DC h9	DC h9		
Dirección												
Grupo básico estándar (BSG)												
Código de Familia de Producto	S765	S765HB	S637	S610	S611	S638	S650	S654	S614	S536		
Gama de diámetros de corte PSF	6.00 – 20.00	6.00 – 20.00	2.00 – 12.00	2.00 – 20.00	3.00 – 20.00	6.20 – 20.30	1.00 – 20.00	6.00 – 20.00	3.00 – 16.00	6.00 – 12.00		
	110	111	112	113	114	115	116	117	118	119		
P	P1	■	■									
	P2	■	■									
	P3	■	■									
	P4	■	■									
M	M1	■	■									
	M2	■	■									
	M3	■	■									
	M4											
K	K1	■	■									
	K2	■	■									
	K3	■	■									
	K4	■	■									
	K5	■	■									
N	N1			■	■	■	■	■	■			
	N2			■	■	■	■	■	■			
	N3			■	■	■	■	■	■			
	N4			■	■	■	■	■	■			
	N5											
S	S1	■	■									
	S2	■	■									
	S3	■	■									
	S4	■	■									
H	H1									■		
	H2									■		
	H3									■		
	H4									■		

S765



Fresa de Metal Duro de 4 Filos para Desbaste, Mango HA DIN 6535

Fresa con longitud de corte corta de 4 filos, con hélice a 40° y paso diferencial para reducir vibraciones. El perfil NRA está diseñado para romper la viruta y proporcionar operaciones de desbaste eficientes. El recubrimiento AlCrN mejora el rendimiento y aumenta la vida de la herramienta. Adecuada también para operaciones de ranurado y desbaste trocoidal.

HM	NRA	NOF 4#
	λ 40°	γ 10°
DIN 6535HA	AlCrN	DC h9
	DORMER	

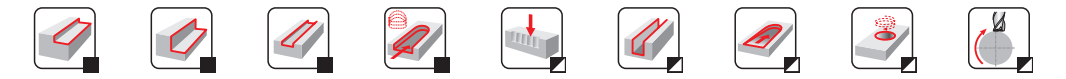
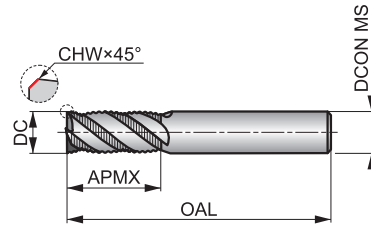

Grupo de Material de la pieza adecuado. Valores de inicio de la velocidad de corte (m/min) y código alfabético. Las tablas con avances por diente y factores de corrección en la pag. 266.

P1.1 ■ 211 J	P1.2 ■ 236 J	P1.3 ■ 243 J	P2.1 ■ 180 J	P2.2 ■ 158 J	P2.3 ■ 140 J	P3.1 ■ 146 J	P3.2 ■ 117 J	P3.3 ■ 99 J	P4.1 ■ 86 J	P4.2 ■ 74 J	M1.1 ■ 122 J	M1.2 ■ 103 J	M2.1 ■ 108 J
M2.2 ■ 89 J	M3.1 ■ 100 J	M3.2 ■ 86 J	K1.1 ■ 208 J	K1.2 ■ 154 J	K1.3 ■ 116 J	K2.1 ■ 214 J	K2.2 ■ 174 J	K2.3 ■ 139 J	K3.1 ■ 189 J	K3.2 ■ 145 J	K3.3 ■ 117 J	K4.1 ■ 176 J	K4.2 ■ 132 J
K4.3 ■ 97 J	K4.4 ■ 83 I	K4.5 ■ 69 I	K5.1 ■ 199 J	K5.2 ■ 149 J	K5.3 ■ 116 J	S1.2 ■ 72 J	S2.1 ■ 56 I	S3.1 ■ 42 I	S4.1 ■ 33 I				

DCON MS tolerancia h6; CHW ±0.02×45° mm.

Product	DC (mm)	CHW (mm)	DCON MS (mm)	APMX (mm)	OAL (mm)	NOF
S7656.0	6.00	0.10	6.00	16.00	50.0	4
S7658.0	8.00	0.20	8.00	20.00	64.0	4
S76510.0	10.00	0.20	10.00	22.00	70.0	4
S76512.0	12.00	0.20	12.00	26.00	75.0	4
S76514.0	14.00	0.30	14.00	32.00	90.0	4
S76516.0	16.00	0.30	16.00	32.00	90.0	4
S76518.0	18.00	0.30	18.00	38.00	100.0	4
S76520.0	20.00	0.40	20.00	38.00	100.0	4

S765HB



Fresa de Metal Duro de 4 Filos para Desbaste, Mango HB DIN 6535

Fresa con longitud de corte corta de 4 filos, con hélice a 40° y paso diferencial para reducir vibraciones. El perfil NRA está diseñado para romper la viruta y proporcionar operaciones de desbaste eficientes. El mango Weldon evita que la fresa se deslice en el portaherramientas. Recubrimiento AlCrN. Adecuada también para operaciones de ranurado y desbaste trocoidal.

HM	NRA	NOF 4#
	λ 40°	γ 10°
DIN 6535HB	AlCrN	DC h9
	DORMER	

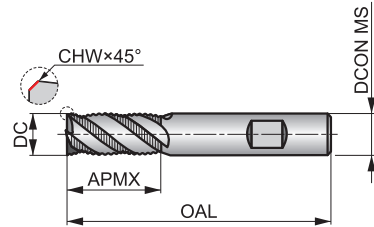

Grupo de Material de la pieza adecuado. Valores de inicio de la velocidad de corte (m/min) y código alfabético. Las tablas con avances por diente y factores de corrección en la pag. 266.

P1.1 ■ 211 J	P1.2 ■ 236 J	P1.3 ■ 243 J	P2.1 ■ 180 J	P2.2 ■ 158 J	P2.3 ■ 140 J	P3.1 ■ 146 J	P3.2 ■ 117 J	P3.3 ■ 99 J	P4.1 ■ 86 J	P4.2 ■ 74 J	M1.1 ■ 122 J	M1.2 ■ 103 J	M2.1 ■ 108 J
M2.2 ■ 89 J	M3.1 ■ 100 J	M3.2 ■ 86 J	K1.1 ■ 208 J	K1.2 ■ 154 J	K1.3 ■ 116 J	K2.1 ■ 214 J	K2.2 ■ 174 J	K2.3 ■ 139 J	K3.1 ■ 189 J	K3.2 ■ 145 J	K3.3 ■ 117 J	K4.1 ■ 176 J	K4.2 ■ 132 J
K4.3 ■ 97 J	K4.4 ■ 83 I	K4.5 ■ 69 I	K5.1 ■ 199 J	K5.2 ■ 149 J	K5.3 ■ 116 J	S1.2 ■ 72 J	S2.1 ■ 56 I	S3.1 ■ 42 I	S4.1 ■ 33 I				

DCON MS tolerancia h6; CHW ±0.02×45° mm.

Product	DC (mm)	CHW (mm)	DCON MS (mm)	APMX (mm)	OAL (mm)	NOF
S765HB6.0	6.00	0.10	6.00	16.00	50.0	4
S765HB8.0	8.00	0.20	8.00	20.00	64.0	4
S765HB10.0	10.00	0.20	10.00	22.00	70.0	4
S765HB12.0	12.00	0.20	12.00	26.00	75.0	4
S765HB14.0	14.00	0.30	14.00	32.00	90.0	4
S765HB16.0	16.00	0.30	16.00	32.00	90.0	4
S765HB18.0	18.00	0.30	18.00	38.00	100.0	4
S765HB20.0	20.00	0.40	20.00	38.00	100.0	4

S637



Fresa de Metal Duro de Un Solo Filo

Fresa con longitud de corte corta de 1 filo que proporciona un alto rendimiento en operaciones de ranurado. La S637, con geometría super positiva, está diseñada para un mecanizado de alta velocidad en paredes delgadas de materiales no féreos. La superficie pulida evita que el material de la pieza se adhiera al filo de corte.

HM	W	NOF 1
	λ 25°	γ 20°
DIN 6535HA	Hi	DC h9

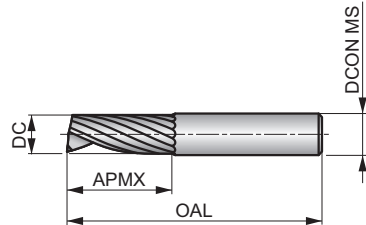

Grupo de Material de la pieza adecuado. Valores de inicio de la velocidad de corte (m/min) y código alfabético. Las tablas con avances por diente y factores de corrección en la pag. 266.

- N1.1**
■ 709 R
- N1.2**
■ 533 R
- N1.3**
■ 357 R
- N2.1**
■ 357 P
- N2.2**
■ 320 P
- N2.3**
■ 229 P
- N3.1**
■ 373 P
- N3.2**
■ 219 P
- N3.3**
■ 112 P
- N4.1**
■ 373 S
- N4.2**
■ 144 S

DCON MS tolerancia h6.

Product	DC (mm)	DCON MS (mm)	APMX (mm)	OAL (mm)	NOF
S6372.0	2.00	2.00	10.00	40.0	1
S6373.0	3.00	3.00	12.00	40.0	1
S6374.0	4.00	4.00	15.00	50.0	1
S6375.0	5.00	5.00	16.00	50.0	1
S6376.0	6.00	6.00	20.00	60.0	1
S6378.0	8.00	8.00	22.00	63.0	1
S63710.0	10.00	10.00	25.00	72.0	1
S63712.0	12.00	12.00	30.00	83.0	1

S610



Fresa de Metal Duro de 2 Filos

Fresa con longitud de corte corta de 2 filos que proporciona alta rigidez en fresado de ranuras estándar y perfilado. La S610, con geometría super positiva, está diseñada para un mecanizado de alto rendimiento en materiales no féreos. La superficie pulida evita que el material de la pieza se adhiera al filo de corte.

HM	W	NOF 2
	λ 30°	γ 20°
DIN 6535HA	Hi	DC h9

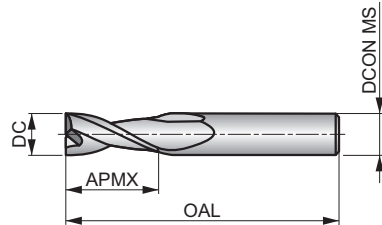

Grupo de Material de la pieza adecuado. Valores de inicio de la velocidad de corte (m/min) y código alfabético. Las tablas con avances por diente y factores de corrección en la pag. 266.

N1.1 ■ 709 P	N1.2 ■ 533 P	N1.3 ■ 357 P	N2.1 ■ 357 O	N2.2 ■ 320 O	N2.3 ■ 229 O	N3.1 ■ 373 O	N3.2 ■ 219 O	N3.3 ■ 112 O	N4.1 ■ 373 R	N4.2 ■ 144 R
------------------------	------------------------	------------------------	------------------------	------------------------	------------------------	------------------------	------------------------	------------------------	------------------------	------------------------

DCON MS tolerancia h6; RE ±0.02 mm.

Product	DC (mm)	RE (mm)	DCON MS (mm)	APMX (mm)	OAL (mm)	NOF
S6102.0	2.00	0.10	4.00	6.50	40.0	2
S6103.0XD3	3.00	0.10	3.00	9.00	40.0	2
S6103.0XD6	3.00	0.10	6.00	9.00	50.0	2
S6104.0XD4	4.00	0.10	4.00	12.00	50.0	2
S6104.0XD6	4.00	0.10	6.00	12.00	50.0	2
S6105.0	5.00	0.10	6.00	15.00	50.0	2
S6106.0	6.00	0.10	6.00	20.00	50.0	2
S6108.0	8.00	0.10	8.00	20.00	64.0	2
S61010.0	10.00	0.10	10.00	22.00	75.0	2
S61012.0	12.00	0.10	12.00	25.00	75.0	2
S61014.0	14.00	0.10	14.00	32.00	90.0	2
S61016.0	16.00	0.10	16.00	32.00	90.0	2
S61020.0	20.00	0.10	20.00	38.00	100.0	2

S611



Fresa de Metal Duro de 2 Filos, Serie Extra Larga

Fresa con longitud de corte corta de 2 filos con cuello reducido, que proporciona alta rigidez en fresado y perfilado en zonas de difícil acceso. La S611, con geometría super positiva, está diseñada para un mecanizado de alto rendimiento en materiales no féreos. La superficie pulida evita que el material de la pieza se adhiera al filo de corte.

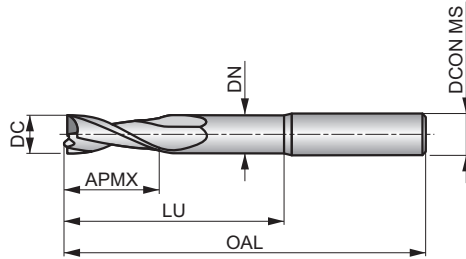

HM	W	NOF 2
	λ 30°	γ 20°
DIN 6535HA	Hi	DC h9



Grupo de Material de la pieza adecuado. Valores de inicio de la velocidad de corte (m/min) y código alfabético. Las tablas con avances por diente y factores de corrección en la pag. 266.

N1.1 ■ 638 P	N1.2 ■ 480 P	N1.3 ■ 321 P	N2.1 ■ 321 O	N2.2 ■ 288 O	N2.3 ■ 206 O	N3.1 ■ 336 O	N3.2 ■ 197 O	N3.3 ■ 101 O	N4.1 ■ 336 R	N4.2 ■ 130 R
------------------------	------------------------	------------------------	------------------------	------------------------	------------------------	------------------------	------------------------	------------------------	------------------------	------------------------

DCON MS tolerancia h6; RE ±0.02 mm.

Product	DC (mm)	RE (mm)	DCON MS (mm)	APMX (mm)	OAL (mm)	NOF	LU (mm)	DN (mm)
S6113.0XD3	3.00	0.10	3.00	9.00	40.0	2	15.00	2.80
S6113.0XD6	3.00	0.10	6.00	9.00	50.0	2	15.00	2.80
S6114.0XD4	4.00	0.10	4.00	12.00	50.0	2	20.00	3.70
S6114.0XD6	4.00	0.10	6.00	12.00	50.0	2	20.00	3.70
S6115.0	5.00	0.10	6.00	15.00	50.0	2	20.00	4.60
S6116.0	6.00	0.10	6.00	16.00	80.0	2	40.00	5.50
S6118.0	8.00	0.10	8.00	20.00	80.0	2	40.00	7.40
S61110.0	10.00	0.10	10.00	22.00	100.0	2	60.00	9.20
S61112.0	12.00	0.10	12.00	25.00	100.0	2	60.00	11.00
S61114.0	14.00	0.10	14.00	32.00	125.0	2	75.00	13.00
S61116.0	16.00	0.10	16.00	32.00	125.0	2	75.00	15.00
S61120.0	20.00	0.10	20.00	38.00	125.0	2	75.00	19.00

S638



Fresa de Metal Duro de 2 Filos, Alcance Extra Largo

Fresa con longitud de corte extra corta de 2 filos, con mango rebajado que proporciona espacio al mecanizar paredes profundas. La S638, con geometría super positiva, está diseñada para mecanizado de alta velocidad en materiales no férreos. La superficie pulida evita que el material de la pieza se adhiera al filo de corte.

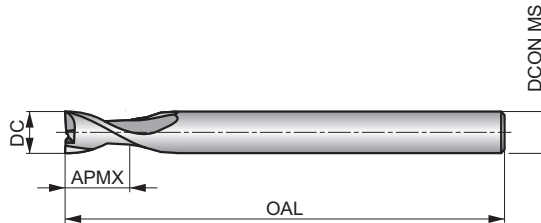

HM	W	NOF 2
	λ 30°	γ 20°
DIN 6335HA	Hi	DC h9



Grupo de Material de la pieza adecuado. Valores de inicio de la velocidad de corte (m/min) y código alfabético. Las tablas con avances por diente y factores de corrección en la pag. 266.

N1.1	N1.2	N1.3	N2.1	N2.2	N2.3	N3.1	N3.2	N3.3	N4.1	N4.2
■ 709 N	■ 533 N	■ 357 N	■ 357 N	■ 320 N	■ 229 N	■ 373 N	■ 219 N	■ 112 N	■ 373 0	■ 144 0

Mango Reducido; DCON MS tolerancia h6; RE ±0.02 mm.

Product	DC (mm)	RE (mm)	DCON MS (mm)	APMX (mm)	OAL (mm)	NOF
S6386.2	6.20	0.10	6.00	8.00	100.0	2
S6388.2	8.20	0.10	8.00	10.00	100.0	2
S63810.3	10.30	0.10	10.00	14.00	125.0	2
S63812.3	12.30	0.10	12.00	16.00	125.0	2
S63816.3	16.30	0.10	16.00	20.00	125.0	2
S63820.3	20.30	0.10	20.00	25.00	125.0	2

S650



Fresa de Metal Duro de 3 Filos

Fresa con longitud de corte corta de 3 filos con paso diferencial para reducir vibraciones, reducir la carga en el husillo y mejorar el acabado superficial. El rompevirutas único frontal ayuda a romper la viruta para su fácil evacuación en materiales no féreos.

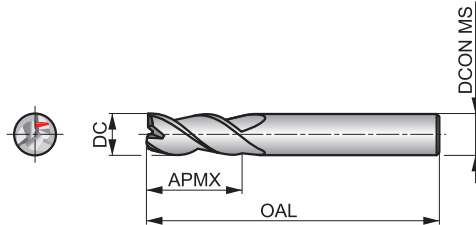

HM	W	NOF 3#
	λ 40°	γ 13°
DIN 6535HA	Bright	DC h9

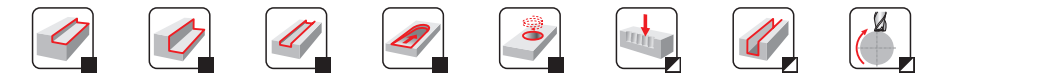

Grupo de Material de la pieza adecuado. Valores de inicio de la velocidad de corte (m/min) y código alfabético. Las tablas con avances por diente y factores de corrección en la pag. 266.

N1.1 ■ 780 O	N1.2 ■ 608 O	N1.3 ■ 393 O	N2.1 ■ 393 N	N2.2 ■ 352 N	N2.3 ■ 252 N	N3.1 ■ 410 N	N3.2 ■ 241 N	N3.3 ■ 123 N	N4.1 ■ 410 P	N4.2 ■ 158 P
------------------------	------------------------	------------------------	------------------------	------------------------	------------------------	------------------------	------------------------	------------------------	------------------------	------------------------

DCON MS tolerancia h6.

Product	DC (mm)	DCON MS (mm)	APMX (mm)	OAL (mm)	NOF
S6501.0	1.00	4.00	3.00	40.0	3
S6501.5	1.50	4.00	4.50	40.0	3
S6502.0	2.00	4.00	6.50	40.0	3
S6502.5	2.50	4.00	6.50	40.0	3
S6503.0XD3	3.00	3.00	9.00	40.0	3
S6503.0XD6	3.00	6.00	9.00	50.0	3
S6504.0XD4	4.00	4.00	12.00	50.0	3
S6504.0XD6	4.00	6.00	12.00	50.0	3
S6505.0	5.00	6.00	15.00	50.0	3
S6506.0	6.00	6.00	16.00	50.0	3
S6508.0	8.00	8.00	20.00	64.0	3
S65010.0	10.00	10.00	22.00	70.0	3
S65012.0	12.00	12.00	25.00	75.0	3
S65014.0	14.00	14.00	32.00	90.0	3
S65016.0	16.00	16.00	32.00	90.0	3
S65020.0 ¹⁾	20.00	20.00	38.00	100.0	3

¹⁾ Sin paso diferencial y divisor de viruta

S654



Fresa de Metal Duro de 3 Filos para Desbaste, Largo Alcance

Fresa con longitud de corte corta de 3 filos para desbaste, con cuello reducido y paso diferencial para reducir vibraciones, maximizar la productividad y la vida de filo. La S654, con perfil NRA, rompe la viruta para su fácil evacuación. Está diseñada para el desbaste de alto rendimiento en materiales no féreos.

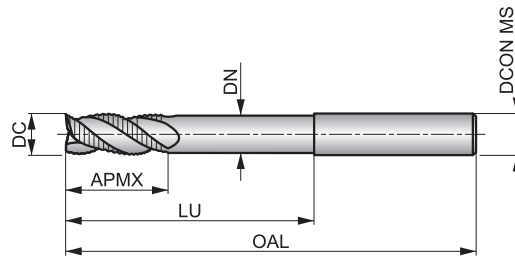

HM	W NRA	NOF 3 \neq
	λ 40°	γ 15°
DIN 6535HA	Bright	DC h9
	DORMER	



Grupo de Material de la pieza adecuado. Valores de inicio de la velocidad de corte (m/min) y código alfabético. Las tablas con avances por diente y factores de corrección en la pag. 266.

- | | | | | | | | | | | |
|------------------------|------------------------|------------------------|------------------------|------------------------|------------------------|------------------------|------------------------|------------------------|------------------------|------------------------|
| N1.1
■ 709 O | N1.2
■ 533 O | N1.3
■ 357 O | N2.1
■ 357 N | N2.2
■ 320 N | N2.3
■ 229 N | N3.1
■ 373 N | N3.2
■ 219 N | N3.3
■ 112 N | N4.1
■ 373 P | N4.2
■ 144 P |
|------------------------|------------------------|------------------------|------------------------|------------------------|------------------------|------------------------|------------------------|------------------------|------------------------|------------------------|

DCON MS tolerancia h6; RE \pm 0.02 mm.

Product	DC (mm)	RE (mm)	DCON MS (mm)	APMX (mm)	OAL (mm)	NOF	LU (mm)	DN (mm)
S6546.0	6.00	0.10	6.00	13.00	75.0	3	40.00	5.50
S6548.0	8.00	0.10	8.00	20.00	75.0	3	40.00	7.40
S65410.0	10.00	0.10	10.00	22.00	100.0	3	60.00	9.20
S65412.0	12.00	0.12	12.00	26.00	100.0	3	60.00	11.00
S65416.0	16.00	0.16	16.00	32.00	125.0	3	75.00	15.00
S65420.0	20.00	0.20	20.00	40.00	150.0	3	100.00	19.00

S614



Fresa de Metal Duro de 3 Filos, Serie Extra Larga

Fresa con longitud de corte extra larga de 3 filos para aplicaciones de perfilado ligero en áreas de difícil acceso. La S614, con geometría super positiva, está diseñada para fresado de alto rendimiento en materiales no féreos.

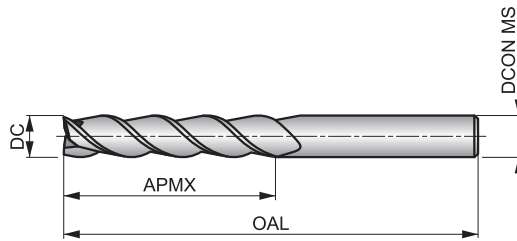

HM	W	NOF 3
	λ 40°	γ 13°
DIN 6535HA	Bright	DC h9



Grupo de Material de la pieza adecuado. Valores de inicio de la velocidad de corte (m/min) y código alfabético. Las tablas con avances por diente y factores de corrección en la pag. 266.

N1.1 ■ 638 G	N1.2 ■ 480 G	N1.3 ■ 321 G	N2.1 ■ 321 F	N2.2 ■ 288 F	N2.3 ■ 206 F	N3.1 ■ 336 F	N3.2 ■ 197 F	N3.3 ■ 101 F	N4.1 ■ 336 I	N4.2 ■ 130 I
------------------------	------------------------	------------------------	------------------------	------------------------	------------------------	------------------------	------------------------	------------------------	------------------------	------------------------

DCON MS tolerancia h6.

Product	DC (mm)	DCON MS (mm)	APMX (mm)	OAL (mm)	NOF
S6143.0XD3	3.00	3.00	19.00	60.0	3
S6143.0XD6	3.00	6.00	19.00	75.0	3
S6144.0XD4	4.00	4.00	19.00	60.0	3
S6144.0XD6	4.00	6.00	19.00	75.0	3
S6145.0	5.00	6.00	19.00	75.0	3
S6146.0	6.00	6.00	31.00	75.0	3
S6148.0	8.00	8.00	41.00	100.0	3
S61410.0	10.00	10.00	50.00	100.0	3
S61412.0	12.00	12.00	50.00	100.0	3
S61414.0	14.00	14.00	57.00	125.0	3
S61416.0	16.00	16.00	57.00	125.0	3

S536



Fresa de Metal Duro de Múltiples Filos con Radio de Esquina

Fresa con longitud de corte extra corta de 4 o 6 filos con radio de esquina, hélice de 25° y geometría específica para mecanizado de alto avance en materiales endurecidos hasta 63 HRC. El recubrimiento TiSiN aumenta la vida útil y mejora el rendimiento.

HM	N	NOF 4-6
	λ 25°	γ 0°
DIN 6535HA	TiSiN	DC h9
	DORMER	

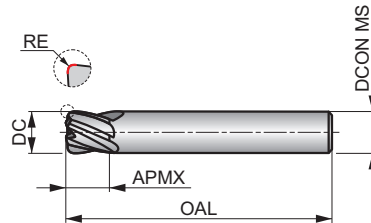

Grupo de Material de la pieza adecuado. Valores de inicio de la velocidad de corte (m/min) y código alfabético. Las tablas con avances por diente y factores de corrección en la pag. 266.

H1.1	H2.1	H2.2	H3.1	H3.2	H4.1	H4.2
■ 205 E	■ 122 E	■ 104 D	■ 135 E	■ 111 E	■ 86 D	■ 73 D

DCON MS tolerancia h6; RE ±0.01 mm.

Product	DC (mm)	RE (mm)	DCON MS (mm)	APMX (mm)	OAL (mm)	NOF
S5366.0XR1.0	6.00	1.00	6.00	6.00	60.0	4
S5368.0XR2.0	8.00	2.00	8.00	8.00	64.0	6
S53610.0XR2.0	10.00	2.00	10.00	10.00	75.0	6
S53612.0XR2.0	12.00	2.00	12.00	12.00	75.0	6

Código de Material (BMC)	HM	HM	HM	HM									
Perfil de la fresa	N	FS	N	FS									
Número de canales (NOF)	NOF 5	NOF 5	NOF 5	NOF 5									
Longitud de corte													
Ángulo de hélice (FHA)	$\lambda \neq$	$\lambda \neq$	$\lambda \neq$	$\lambda \neq$									
Ángulo de incidencia radial (GAMF)	$\gamma 10^\circ$	$\gamma 10^\circ$	$\gamma 10^\circ$	$\gamma 10^\circ$									
Mango													
Clase de tolerancia del diámetro de corte (TCDC)	DC h9	DC h9	DC h9	DC h9									
Recubrimiento	AICN	AICN	AICN	AICN									
Dirección													
Grupo básico estándar (BSG)	DORMER	DORMER	DORMER	DORMER									
Refrigeración (CSP)													

Código de Familia de Producto		S770HB	S771HB	S772HB	S773HB								
Gama de diámetros de corte PSF		10.00 – 20.00	10.00 – 20.00	10.00 – 20.00	10.00 – 20.00								
P	P1	■	■	■	■								
	P2	■	■	■	■								
	P3	■	■	■	■								
	P4	■	■	■	■								
M	M1	■	■	■	■								
	M2	■	■	■	■								
	M3	■	■	■	■								
	M4												
K	K1	■	■	■	■								
	K2	■	■	■	■								
	K3	■	■	■	■								
	K4	■	■	■	■								
	K5	■	■	■	■								
N	N1												
	N2												
	N3												
	N4												
	N5												
S	S1	■	■	■	■								
	S2	■	■	■	■								
	S3	■	■	■	■								
	S4	■	■	■	■								
H	H1												
	H2												
	H3												
	H4												

S770HB

DORMER



Fresa de Metal Duro de 5 Filos

Fresa con longitud de corte corta de 5 filos con hélice desigual para reducir vibraciones, especialmente al utilizarla con estrategias de fresado dinámico. El recubrimiento AlCrN aumenta la vida de la herramienta y mejora el rendimiento. Adecuada para fresado trocoidal, escuadrado, interpolación helicoidal y fresado en rampa.

HM	N	NOF 5
	$\lambda \neq$	γ 10°
DIN 6535HB	AlCrN	DC h9
	DORMER	

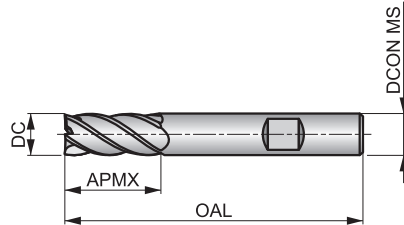

Grupo de Material de la pieza adecuado. Valores de inicio de la velocidad de corte (m/min) y código alfabético. Las tablas con avances por diente y factores de corrección en la pag. 266.

P1.1 ■ 211 I	P1.2 ■ 236 I	P1.3 ■ 243 I	P2.1 ■ 180 I	P2.2 ■ 158 I	P2.3 ■ 140 I	P3.1 ■ 146 I	P3.2 ■ 117 I	P3.3 ■ 99 I	P4.1 ■ 86 I	P4.2 ■ 74 I	M1.1 ■ 122 I	M1.2 ■ 103 I	M2.1 ■ 108 I
M2.2 ■ 89 I	M3.1 ■ 100 I	M3.2 ■ 86 I	K1.1 ■ 208 I	K1.2 ■ 154 I	K1.3 ■ 116 I	K2.1 ■ 214 I	K2.2 ■ 174 I	K2.3 ■ 139 I	K3.1 ■ 189 I	K3.2 ■ 145 I	K3.3 ■ 117 I	K4.1 ■ 176 I	K4.2 ■ 132 I
K4.3 ■ 97 I	K4.4 ■ 83 G	K4.5 ■ 69 G	K5.1 ■ 199 I	K5.2 ■ 149 I	K5.3 ■ 116 I	S1.2 ■ 72 I	S2.1 ■ 56 G	S3.1 ■ 42 G	S4.1 ■ 33 G				

DCON MS tolerancia h6; RE ±0.01 mm.

Product	DC (mm)	RE (mm)	DCON MS (mm)	APMX (mm)	OAL (mm)	NOF
S770HB10.0	10.00	0.20	10.00	22.00	72.0	5
S770HB12.0	12.00	0.30	12.00	26.00	83.0	5
S770HB16.0	16.00	0.30	16.00	32.00	92.0	5
S770HB20.0	20.00	0.30	20.00	38.00	104.0	5

S771HB



Fresa de Metal Duro de 5 Filos con Divisores de viruta y Refrigeración Interna

Fresa con longitud de corte corta de 5 filos con cuello reducido y hélice desigual que ayuda a reducir vibraciones, especialmente al utilizarla con estrategias de fresado dinámico. El recubrimiento AlCrN aumenta la vida de la herramienta y mejora el rendimiento. Rompevirutas y refrigeración interna para mejorar la evacuación de viruta en operaciones de cajeado.

HM	FS	NOF 5
	$\lambda \neq$	$\gamma 10^\circ$
DIN 6535HB	AlCrN	DC h9
	DORMER	

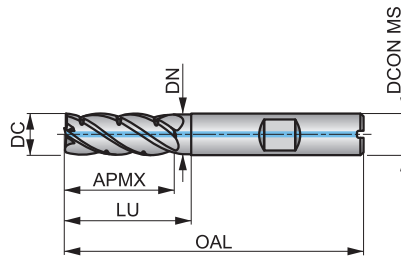

Grupo de Material de la pieza adecuado. Valores de inicio de la velocidad de corte (m/min) y código alfabético. Las tablas con avances por diente y factores de corrección en la pag. 266.

P1.1 ■ 222 J	P1.2 ■ 248 J	P1.3 ■ 255 J	P2.1 ■ 189 J	P2.2 ■ 166 J	P2.3 ■ 147 I	P3.1 ■ 153 J	P3.2 ■ 123 I	P3.3 ■ 104 I	P4.1 ■ 90 I	P4.2 ■ 78 I	M1.1 ■ 128 I	M1.2 ■ 108 I	M2.1 ■ 113 I
M2.2 ■ 93 I	M3.1 ■ 105 I	M3.2 ■ 90 I	K1.1 ■ 218 J	K1.2 ■ 162 J	K1.3 ■ 122 J	K2.1 ■ 225 J	K2.2 ■ 183 J	K2.3 ■ 146 I	K3.1 ■ 198 J	K3.2 ■ 152 I	K3.3 ■ 123 I	K4.1 ■ 185 I	K4.2 ■ 139 I
K4.3 ■ 102 I	K4.4 ■ 87 I	K4.5 ■ 72 I	K5.1 ■ 209 I	K5.2 ■ 156 I	K5.3 ■ 122 I	S1.2 ■ 76 I	S2.1 ■ 59 I	S3.1 ■ 44 G	S4.1 ■ 35 G				

DCON MS tolerancia h6; RE ±0.01 mm.

Product	DC (mm)	RE (mm)	DCON MS (mm)	APMX (mm)	OAL (mm)	NOF	LU (mm)	DN (mm)
S771HB10.0	10.00	0.20	10.00	25.00	72.0	5	30.00	9.70
S771HB12.0	12.00	0.20	12.00	30.00	83.0	5	38.00	11.70
S771HB16.0	16.00	0.30	16.00	39.00	92.0	5	44.00	15.70
S771HB20.0	20.00	0.30	20.00	48.00	104.0	5	54.00	19.70

S772HB



Fresa de Metal Duro de 5 Filos, Serie Larga

Fresa con longitud de corte larga de 5 filos con hélice desigual que ayuda a reducir vibraciones, especialmente al utilizarla con estrategias de fresado dinámico. El recubrimiento AlCrN aumenta la vida de la herramienta y mejora el rendimiento. Adecuada para fresado trocoidal, es cuadrado, interpolación helicoidal y fresado en rampa.

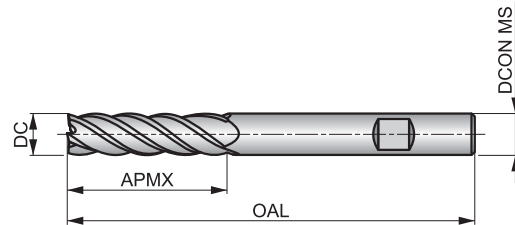

HM	N	NOF 5
	$\lambda \neq$	γ 10°
DIN 6535HB	AlCrN	DC h9



Grupo de Material de la pieza adecuado. Valores de inicio de la velocidad de corte (m/min) y código alfabético. Las tablas con avances por diente y factores de corrección en la pag. 266.

P1.1 ■ 148 G	P1.2 ■ 165 G	P1.3 ■ 170 G	P2.1 ■ 126 G	P2.2 ■ 111 G	P2.3 ■ 98 F	P3.1 ■ 102 G	P3.2 ■ 82 F	P3.3 ■ 69 F	P4.1 ■ 60 F	P4.2 ■ 52 F	M1.1 ■ 85 G	M1.2 ■ 72 G	M2.1 ■ 76 G
M2.2 ■ 62 G	M3.1 ■ 70 G	M3.2 ■ 60 G	K1.1 ■ 146 G	K1.2 ■ 108 G	K1.3 ■ 81 G	K2.1 ■ 150 G	K2.2 ■ 122 G	K2.3 ■ 97 F	K3.1 ■ 132 G	K3.2 ■ 102 G	K3.3 ■ 82 F	K4.1 ■ 123 F	K4.2 ■ 92 F
K4.3 ■ 68 F	K4.4 ■ 58 G	K4.5 ■ 48 G	K5.1 ■ 139 F	K5.2 ■ 104 F	K5.3 ■ 81 F	S1.2 ■ 50 F	S2.1 ■ 39 F	S3.1 ■ 29 F	S4.1 ■ 23 F				

DCON MS tolerancia h6; RE ±0.01 mm.

Product	DC (mm)	RE (mm)	DCON MS (mm)	APMX (mm)	OAL (mm)	NOF
S772HB10.0	10.00	0.20	10.00	38.00	100.0	5
S772HB12.0	12.00	0.30	12.00	45.00	100.0	5
S772HB16.0	16.00	0.30	16.00	55.00	125.0	5
S772HB20.0	20.00	0.30	20.00	65.00	125.0	5

S773HB



Fresa de Metal Duro de 5 Filos con Divisores de Viruta, Serie Larga

Fresa con longitud de corte larga de 5 filos con cuello reducido y hélice desigual que ayuda a reducir vibraciones, especialmente al utilizarla con estrategias de fresado dinámico. El recubrimiento AlCrN aumenta la vida de la herramienta y mejora el rendimiento. Rompevirutas y refrigeración interna para mejorar la evacuación de viruta en operaciones de cajeado.

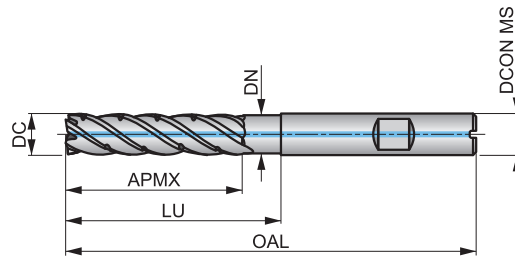

HM	FS	NOF 5
	$\lambda \neq$	γ 10°
DIN 6535HB	AlCrN	DC h9
	DORMER	



Grupo de Material de la pieza adecuado. Valores de inicio de la velocidad de corte (m/min) y código alfabético. Las tablas con avances por diente y factores de corrección en la pag. 266.

P1.1 ■ 155 G	P1.2 ■ 173 G	P1.3 ■ 179 G	P2.1 ■ 132 G	P2.2 ■ 117 G	P2.3 ■ 103 F	P3.1 ■ 107 G	P3.2 ■ 86 F	P3.3 ■ 72 F	P4.1 ■ 63 F	P4.2 ■ 55 F	M1.1 ■ 89 F	M1.2 ■ 76 F	M2.1 ■ 80 F
M2.2 ■ 65 F	M3.1 ■ 74 F	M3.2 ■ 63 F	K1.1 ■ 153 G	K1.2 ■ 113 G	K1.3 ■ 85 G	K2.1 ■ 158 G	K2.2 ■ 128 G	K2.3 ■ 102 F	K3.1 ■ 139 G	K3.2 ■ 107 G	K3.3 ■ 86 F	K4.1 ■ 129 F	K4.2 ■ 97 F
K4.3 ■ 71 F	K4.4 ■ 61 F	K4.5 ■ 50 F	K5.1 ■ 146 F	K5.2 ■ 109 F	K5.3 ■ 85 F	S1.2 ■ 53 F	S2.1 ■ 41 F	S3.1 ■ 30 F	S4.1 ■ 24 F				

DCON MS tolerancia h6; RE ±0.01 mm.

Product	DC (mm)	RE (mm)	DCON MS (mm)	APMX (mm)	OAL (mm)	NOF	LU (mm)	DN (mm)
S773HB10.0	10.00	0.20	10.00	42.00	100.0	5	52.00	9.70
S773HB12.0	12.00	0.20	12.00	42.00	100.0	5	54.00	11.70
S773HB16.0	16.00	0.30	16.00	60.00	125.0	5	68.00	15.70
S773HB20.0	20.00	0.30	20.00	67.00	125.0	5	75.00	19.70

Código de Material (BMC)	HM	HM	HM	HM	HM	HM	HM	HM	HM	HM	HM	HM	HM
Perfil de la fresa	N	N	N	N	N	N	N	N	N	N	W	N	N
Número de canales (NOF)													
Longitud de corte													
Ángulo de hélice (FHA)	λ 40°	λ 40°	λ ≠	λ ≠	λ 40°	λ ≠	λ 40°	λ 40°	λ 40°	λ 40°	λ 40°	λ 45°	λ 40°
Ángulo de hélice (FHA)	λ 40°	λ 40°	λ ≠	λ ≠	λ 40°	λ ≠	λ 40°	λ 40°	λ 40°	λ 40°	λ 40°	λ 45°	λ 40°
Ángulo de incidencia radial (GAMF)	γ 10°	γ 10°	γ 10°	γ 10°	γ 7°	γ 10°	γ 4°	γ 4°	γ 3°	γ 10°	γ 10°	γ -10°	γ -6°
Mango													
Recubrimiento	AICN	AICN	TiSiN	TiSiN	AICN	TiSiN	AICN	AICN	AlTiN	Diamond	Bright	TiSiN	TiSiN
Clase de tolerancia del diámetro de corte (TCDC)	DC h9	DC h9	DC h9	DC h9	DC h9	DC h9	DC h9	DC h9	DC h9	DC h9	DC h9	DC h9	DC h9
Dirección													
Grupo básico estándar (BSG)													
Código de Familia de Producto	S761	S763	S766	S767	S722HB	S768	S260	S262	S219	S612	S662	S521	S523
Gama de diámetros de corte PSF	3.00 – 20.00	3.00 – 20.00	4.00 – 20.00	4.00 – 20.00	3.00 – 20.00	4.00 – 20.00	3.00 – 20.00	3.00 – 20.00	3.00 – 20.00	1.00 – 12.00	3.00 – 20.00	3.00 – 16.00	1.50 – 16.00
P	P1	■	■	■	■	■	■						
	P2	■	■	■	■	■	■						
	P3	■	■	■	■	■	■						
	P4	■	■	■	■	■	■			▣			
M	M1	■	■	■	■	■	■						
	M2	■	■	■	■	■	■	■	■	■			
	M3	■	■	■	■	■	■	■	■	■			
	M4							■	■	■			
K	K1	■	■	■	■	■	■						
	K2	■	■	■	■	■	■						
	K3	■	■	■	■	■	■						
	K4	■	■	■	■	■	■						
	K5	■	■	■	■	■	■						
N	N1										■		
	N2										■		
	N3										■		
	N4										■		
	N5										■		
S	S1	■	■	■	■	■	■	■	■	■			
	S2	■	■	■	■	■	■	■	■	■			
	S3	■	■	■	■	■	■	■	■	■			
	S4	■	■	■	■	■	■	■	■	■			
H	H1						■	■				■	■
	H2						■	■				■	■
	H3						■	■				■	■
	H4											■	■



ISO
13399



PMK
NSH

HM

HM

N

N



λ
40°

λ
40°

λ
40°

λ
40°

γ
-6°

γ
-6°



DC
h9

DC
h9



DORMER

DORMER



S524

S561

3.00 – 16.00

1.00 – 20.00

143

144

P1

P2

P3

P4

M1

M2

M3

M4

K1

K2

K3

K4

K5

N1

N2

N3

N4

N5

S1

S2

S3

S4

H1

H2

H3

H4



■ Primera Opción

▣ Opción Alternativa

S761



Fresa de Metal Duro de 4 Filos

Fresa con longitud de corte corta de 4 filos, con hélice a 40° y paso diferencial para reducir vibraciones y mejorar el acabado superficial en operaciones de perfilado. El recubrimiento AlCrN mejora el rendimiento y aumenta la vida de la herramienta.. Adecuada también para operaciones fresado axial (plunge), fresado en rampa y fresado trocoidal.

HM	N	NOF 4#
	λ 40°	γ 10°
DIN 6535HA	AlCrN	DC h9
	DORMER	

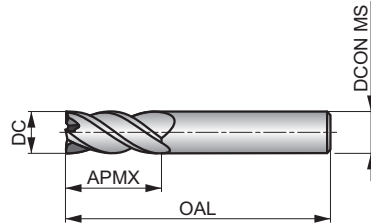

Grupo de Material de la pieza adecuado. Valores de inicio de la velocidad de corte (m/min) y código alfabético. Las tablas con avances por diente y factores de corrección en la pag. 266.

P1.1 ■ 211 J	P1.2 ■ 236 J	P1.3 ■ 243 J	P2.1 ■ 180 J	P2.2 ■ 158 J	P2.3 ■ 140 I	P3.1 ■ 146 J	P3.2 ■ 117 I	P3.3 ■ 99 I	P4.1 ■ 86 I	P4.2 ■ 74 I	M1.1 ■ 122 J	M1.2 ■ 103 J	M2.1 ■ 108 J
M2.2 ■ 89 I	M3.1 ■ 100 I	M3.2 ■ 86 I	K1.1 ■ 208 J	K1.2 ■ 154 J	K1.3 ■ 116 J	K2.1 ■ 214 J	K2.2 ■ 174 J	K2.3 ■ 139 I	K3.1 ■ 189 J	K3.2 ■ 145 J	K3.3 ■ 117 I	K4.1 ■ 176 I	K4.2 ■ 132 I
K4.3 ■ 97 I	K4.4 ■ 83 I	K4.5 ■ 69 I	K5.1 ■ 199 I	K5.2 ■ 149 I	K5.3 ■ 116 I	S1.2 ■ 72 I	S2.1 ■ 56 I	S3.1 ■ 42 I	S4.1 ■ 33 I				

DCON MS tolerancia h6.

Product	DC (mm)	DCON MS (mm)	APMX (mm)	OAL (mm)	NOF
S7613.0	3.00	6.00	9.00	57.0	4
S7614.0	4.00	6.00	12.00	57.0	4
S7615.0	5.00	6.00	13.00	57.0	4
S7616.0	6.00	6.00	13.00	57.0	4
S7618.0	8.00	8.00	20.00	64.0	4
S76110.0	10.00	10.00	22.00	72.0	4
S76112.0	12.00	12.00	26.00	83.0	4
S76114.0	14.00	14.00	32.00	83.0	4
S76116.0	16.00	16.00	32.00	92.0	4
S76120.0	20.00	20.00	38.00	104.0	4

S763



Fresa de Metal Duro de 4 Filos con Radio de Esquina

Fresa con longitud de corte corta de 4 filos con diferentes radios de esquina disponibles y hélice a 40°, con paso diferencial, para reducir vibraciones y mejorar el acabado superficial en operaciones de contorneado donde se requiere un radio. El recubrimiento AlCrN mejora el rendimiento. Adecuada también para fresado axial (plunge), fresado en rampa, interpolación helicoidal y desbaste en Z.

HM	N	NOF 4#
	λ 40°	γ 10°
DIN 6535HA	AlCrN	DC h9

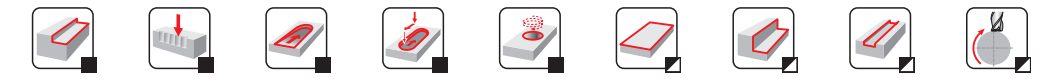
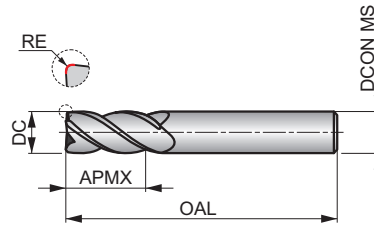

Grupo de Material de la pieza adecuado. Valores de inicio de la velocidad de corte (m/min) y código alfabético. Las tablas con avances por diente y factores de corrección en la pag. 266.

P1.1 ■ 211 J	P1.2 ■ 236 J	P1.3 ■ 243 J	P2.1 ■ 180 J	P2.2 ■ 158 J	P2.3 ■ 140 I	P3.1 ■ 146 J	P3.2 ■ 117 I	P3.3 ■ 99 I	P4.1 ■ 86 I	P4.2 ■ 74 I	M1.1 ■ 122 J	M1.2 ■ 103 J	M2.1 ■ 108 J
M2.2 ■ 89 I	M3.1 ■ 100 I	M3.2 ■ 86 I	K1.1 ■ 208 J	K1.2 ■ 154 J	K1.3 ■ 116 J	K2.1 ■ 214 J	K2.2 ■ 174 J	K2.3 ■ 139 I	K3.1 ■ 189 J	K3.2 ■ 145 J	K3.3 ■ 117 I	K4.1 ■ 176 I	K4.2 ■ 132 I
K4.3 ■ 97 I	K4.4 ■ 83 I	K4.5 ■ 69 I	K5.1 ■ 199 I	K5.2 ■ 149 I	K5.3 ■ 116 I	S1.2 ■ 72 I	S2.1 ■ 56 I	S3.1 ■ 42 I	S4.1 ■ 33 I				

DCON MS tolerancia h6; RE ±0.01 mm.

Product	DC (mm)	RE (mm)	DCON MS (mm)	APMX (mm)	OAL (mm)	NOF
S7633.0XR0.3	3.00	0.30	3.00	9.00	40.0	4
S7634.0XR0.3	4.00	0.30	4.00	12.00	50.0	4
S7634.0XR0.5	4.00	0.50	4.00	12.00	50.0	4
S7635.0XR0.3	5.00	0.30	5.00	15.00	50.0	4
S7635.0XR0.5	5.00	0.50	5.00	15.00	50.0	4
S7636.0XR0.5	6.00	0.50	6.00	16.00	50.0	4
S7636.0XR1.0	6.00	1.00	6.00	16.00	50.0	4
S7638.0XR0.5	8.00	0.50	8.00	20.00	64.0	4
S7638.0XR1.0	8.00	1.00	8.00	20.00	64.0	4
S76310.0XR0.5	10.00	0.50	10.00	22.00	70.0	4
S76310.0XR1.0	10.00	1.00	10.00	22.00	70.0	4
S76310.0XR2.0	10.00	2.00	10.00	22.00	70.0	4
S76312.0XR1.0	12.00	1.00	12.00	25.00	75.0	4
S76312.0XR2.0	12.00	2.00	12.00	25.00	75.0	4
S76312.0XR3.0	12.00	3.00	12.00	25.00	75.0	4
S76314.0XR1.5	14.00	1.50	14.00	32.00	90.0	4
S76316.0XR1.0	16.00	1.00	16.00	32.00	90.0	4
S76316.0XR2.0	16.00	2.00	16.00	32.00	90.0	4
S76316.0XR3.0	16.00	3.00	16.00	32.00	90.0	4
S76318.0XR2.0	18.00	2.00	18.00	38.00	100.0	4
S76320.0XR3.0	20.00	3.00	20.00	38.00	100.0	4

S766

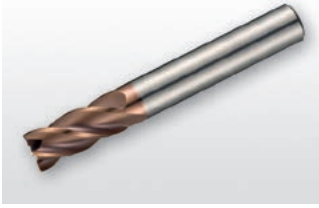

Fresa de Metal Duro de 4 Filos

Fresa con longitud de corte corta de 4 filos, con hélice desigual y paso diferencial para reducir vibraciones y mejorar el acabado superficial en operaciones de perfilado. El recubrimiento TiSiN incrementa la vida de la herramienta y mejora el rendimiento. Adecuada también para fresado axial (plunge), fresado en rampa y fresado trocoidal.

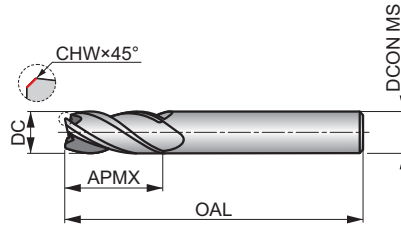

HM	N	NOF 4#
	$\lambda \neq$	γ 10°
DIN 6335HA	TiSiN	DC h9



Grupo de Material de la pieza adecuado. Valores de inicio de la velocidad de corte (m/min) y código alfabético. Las tablas con avances por diente y factores de corrección en la pag. 266.

P1.1 ■ 211 J	P1.2 ■ 236 J	P1.3 ■ 243 J	P2.1 ■ 180 J	P2.2 ■ 158 J	P2.3 ■ 140 I	P3.1 ■ 146 J	P3.2 ■ 117 I	P3.3 ■ 99 I	P4.1 ■ 86 I	P4.2 ■ 74 I	M1.1 ■ 122 J	M1.2 ■ 103 J	M2.1 ■ 108 J
M2.2 ■ 89 I	M3.1 ■ 100 I	M3.2 ■ 86 I	K1.1 ■ 208 J	K1.2 ■ 154 J	K1.3 ■ 116 J	K2.1 ■ 214 J	K2.2 ■ 174 J	K2.3 ■ 139 I	K3.1 ■ 189 J	K3.2 ■ 145 J	K3.3 ■ 117 I	K4.1 ■ 176 I	K4.2 ■ 132 I
K4.3 ■ 97 I	K4.4 ■ 83 I	K4.5 ■ 69 I	K5.1 ■ 199 I	K5.2 ■ 149 I	K5.3 ■ 116 I	S1.2 ■ 72 I	S2.1 ■ 56 I	S3.1 ■ 42 I	S4.1 ■ 33 I				

DCON MS tolerancia h6; CHW $\pm 0.02 \times 45^\circ$ mm.

Product	DC (mm)	CHW (mm)	DCON MS (mm)	APMX (mm)	OAL (mm)	NOF
S7664.0	4.00	0.10	6.00	11.00	57.0	4
S7665.0	5.00	0.10	6.00	13.00	57.0	4
S7666.0	6.00	0.10	6.00	13.00	57.0	4
S7668.0	8.00	0.20	8.00	20.00	64.0	4
S76610.0	10.00	0.20	10.00	22.00	72.0	4
S76612.0	12.00	0.20	12.00	26.00	83.0	4
S76614.0	14.00	0.30	14.00	26.00	83.0	4
S76616.0	16.00	0.30	16.00	32.00	92.0	4
S76620.0	20.00	0.40	20.00	38.00	104.0	4

S767



Fresa de Metal Duro de 4 Filos con Radio de Esquina

Fresa con longitud de corte corta de 4 filos, con diferentes radios de esquina disponibles, hélice desigual y paso diferencial para reducir vibraciones y mejorar el acabado superficial en operaciones de contorneado donde se requiere un radio. El recubrimiento TiSiN mejora el rendimiento. Adecuada también para fresado axial (plunge), fresado en rampa y desbaste en Z.

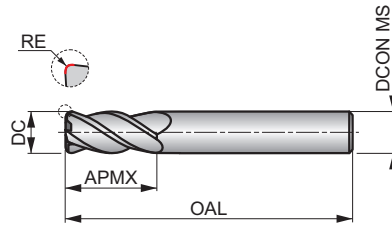

HM	N	NOF 4#
	$\lambda \neq$	γ 10°
DIN 6535HA	TiSiN	DC h9

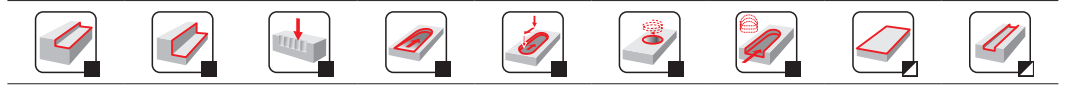

Grupo de Material de la pieza adecuado. Valores de inicio de la velocidad de corte (m/min) y código alfabético. Las tablas con avances por diente y factores de corrección en la pag. 266.

P1.1 ■ 211 J	P1.2 ■ 236 J	P1.3 ■ 243 J	P2.1 ■ 180 J	P2.2 ■ 158 J	P2.3 ■ 140 I	P3.1 ■ 146 J	P3.2 ■ 117 I	P3.3 ■ 99 I	P4.1 ■ 86 I	P4.2 ■ 74 I	M1.1 ■ 122 J	M1.2 ■ 103 J	M2.1 ■ 108 J
M2.2 ■ 89 I	M3.1 ■ 100 I	M3.2 ■ 86 I	K1.1 ■ 208 J	K1.2 ■ 154 J	K1.3 ■ 116 J	K2.1 ■ 214 J	K2.2 ■ 174 J	K2.3 ■ 139 I	K3.1 ■ 189 J	K3.2 ■ 145 J	K3.3 ■ 117 I	K4.1 ■ 176 I	K4.2 ■ 132 I
K4.3 ■ 97 I	K4.4 ■ 83 I	K4.5 ■ 69 I	K5.1 ■ 199 I	K5.2 ■ 149 I	K5.3 ■ 116 I	S1.2 ■ 72 I	S2.1 ■ 56 I	S3.1 ■ 42 I	S4.1 ■ 33 I				

DCON MS tolerancia h6; RE ±0.01 mm.

Product	DC (mm)	RE (mm)	DCON MS (mm)	APMX (mm)	OAL (mm)	NOF
S7674.0XR0.3	4.00	0.30	6.00	11.00	57.0	4
S7674.0XR0.5	4.00	0.50	6.00	11.00	57.0	4
S7675.0XR0.3	5.00	0.30	6.00	13.00	57.0	4
S7675.0XR0.5	5.00	0.50	6.00	13.00	57.0	4
S7676.0XR0.3	6.00	0.30	6.00	13.00	57.0	4
S7676.0XR0.5	6.00	0.50	6.00	13.00	57.0	4
S7676.0XR1.0	6.00	1.00	6.00	13.00	57.0	4
S7678.0XR0.3	8.00	0.30	8.00	20.00	64.0	4
S7678.0XR0.5	8.00	0.50	8.00	20.00	64.0	4
S7678.0XR1.0	8.00	1.00	8.00	20.00	64.0	4
S76710.0XR0.3	10.00	0.30	10.00	22.00	72.0	4
S76710.0XR0.5	10.00	0.50	10.00	22.00	72.0	4
S76710.0XR1.0	10.00	1.00	10.00	22.00	72.0	4
S76712.0XR0.3	12.00	0.30	12.00	26.00	83.0	4
S76712.0XR0.5	12.00	0.50	12.00	26.00	83.0	4
S76712.0XR1.0	12.00	1.00	12.00	26.00	83.0	4
S76712.0XR2.0	12.00	2.00	12.00	26.00	83.0	4
S76716.0XR0.3	16.00	0.30	16.00	32.00	92.0	4
S76716.0XR0.5	16.00	0.50	16.00	32.00	92.0	4
S76716.0XR1.0	16.00	1.00	16.00	32.00	92.0	4
S76716.0XR2.0	16.00	2.00	16.00	32.00	92.0	4
S76720.0XR0.3	20.00	0.30	20.00	38.00	104.0	4
S76720.0XR0.5	20.00	0.50	20.00	38.00	104.0	4
S76720.0XR1.0	20.00	1.00	20.00	38.00	104.0	4
S76720.0XR2.0	20.00	2.00	20.00	38.00	104.0	4

S722HB

DORMER



Fresa de Metal Duro de 4 Filos

Fresa con longitud de corte media de 4 filos con hélice de 40°, paso diferencial y mango Weldon que proporciona alta rigidez en el perfilado de paredes profundas. Cuello reducido para evitar el contacto con la pieza. El recubrimiento Alcrona mejora el rendimiento y aumenta la vida de la herramienta.

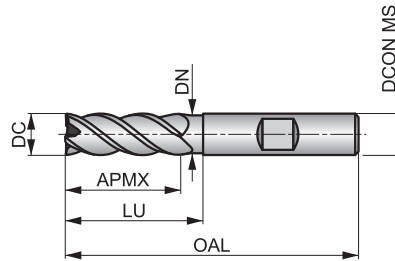

HM	N	NOF 4#
	λ 40°	γ 7°
DIN 6535HB	AlCrN	DC h9
	DORMER	



Grupo de Material de la pieza adecuado. Valores de inicio de la velocidad de corte (m/min) y código alfabético. Las tablas con avances por diente y factores de corrección en la pag. 266.

P1.1 ■ 199 J	P1.2 ■ 223 J	P1.3 ■ 230 J	P2.1 ■ 170 J	P2.2 ■ 150 J	P2.3 ■ 133 I	P3.1 ■ 138 J	P3.2 ■ 111 I	P3.3 ■ 94 I	P4.1 ■ 82 I	P4.2 ■ 70 I	M1.1 ■ 115 J	M1.2 ■ 97 J	M2.1 ■ 102 J
M2.2 ■ 84 I	M3.1 ■ 94 I	M3.2 ■ 81 I	K1.1 ■ 196 J	K1.2 ■ 145 J	K1.3 ■ 109 J	K2.1 ■ 202 J	K2.2 ■ 164 J	K2.3 ■ 131 I	K3.1 ■ 178 J	K3.2 ■ 136 J	K3.3 ■ 110 I	K4.1 ■ 165 I	K4.2 ■ 125 I
K4.3 ■ 91 I	K4.4 ■ 78 I	K4.5 ■ 65 I	K5.1 ■ 187 I	K5.2 ■ 141 I	K5.3 ■ 109 I	S1.2 ■ 69 I	S2.1 ■ 53 I	S3.1 ■ 40 I	S4.1 ■ 31 I				

DCON MS tolerancia h6; RE ±0.02 mm.

Product	DC (mm)	RE (mm)	DCON MS (mm)	APMX (mm)	OAL (mm)	NOF	LU (mm)	DN (mm)
S722HB3.0	3.00	0.10	6.00	9.00	50.0	4	15.00	2.80
S722HB4.0	4.00	0.10	6.00	11.00	57.0	4	20.00	3.70
S722HB5.0	5.00	0.10	6.00	13.00	57.0	4	20.00	4.60
S722HB6.0	6.00	0.10	6.00	20.00	60.0	4	25.00	5.50
S722HB8.0	8.00	0.20	8.00	20.00	64.0	4	26.00	7.40
S722HB10.0	10.00	0.20	10.00	27.00	70.0	4	32.00	9.20
S722HB12.0	12.00	0.20	12.00	26.00	83.0	4	37.00	11.00
S722HB14.0	14.00	0.20	14.00	26.00	83.0	4	37.00	13.00
S722HB16.0	16.00	0.20	16.00	32.00	92.0	4	42.00	15.00
S722HB18.0	18.00	0.20	18.00	32.00	92.0	4	42.00	17.00
S722HB20.0	20.00	0.20	20.00	38.00	104.0	4	50.00	19.00

S768



Fresa de Metal Duro de 4 Filos, Serie Larga

Fresa con longitud de corte larga de 4 filos con hélice desigual y paso diferencial para reducir vibraciones y mejorar el acabado superficial en aplicaciones de perfilado en paredes profundas. Cuello reducido para evitar el contacto con la pieza. El recubrimiento TiSiN aumenta la vida útil y mejora el rendimiento al fresar materiales endurecidos hasta 63 HRC.

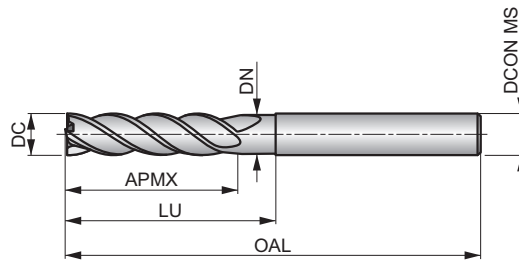

HM	N	NOF 4#
	$\lambda \neq$	γ 10°
DIN 6535HA	TiSiN	DC h9
	DORMER	



Grupo de Material de la pieza adecuado. Valores de inicio de la velocidad de corte (m/min) y código alfabético. Las tablas con avances por diente y factores de corrección en la pag. 266.

P1.1 ■ 148 I	P1.2 ■ 165 I	P1.3 ■ 170 I	P2.1 ■ 126 I	P2.2 ■ 111 I	P2.3 ■ 98 G	P3.1 ■ 102 I	P3.2 ■ 82 G	P3.3 ■ 69 G	P4.1 ■ 60 G	P4.2 ■ 52 G	M1.1 ■ 85 I	M1.2 ■ 72 I	M2.1 ■ 76 I
M2.2 ■ 62 I	M3.1 ■ 70 I	M3.2 ■ 60 I	K1.1 ■ 146 I	K1.2 ■ 108 I	K1.3 ■ 81 I	K2.1 ■ 150 I	K2.2 ■ 122 I	K2.3 ■ 97 G	K3.1 ■ 132 I	K3.2 ■ 102 I	K3.3 ■ 82 G	K4.1 ■ 123 G	K4.2 ■ 92 G
K4.3 ■ 68 G	K4.4 ■ 58 I	K4.5 ■ 48 I	K5.1 ■ 139 G	K5.2 ■ 104 G	K5.3 ■ 81 G	S1.2 ■ 50 I	S2.1 ■ 39 G	S3.1 ■ 29 G	S4.1 ■ 23 G				

DCON MS tolerancia h6; RE ±0.01 mm.

Product	DC (mm)	RE (mm)	DCON MS (mm)	APMX (mm)	OAL (mm)	NOF	LU (mm)	DN (mm)
S7684.0	4.00	0.10	6.00	19.00	75.0	4	32.00	3.70
S7685.0	5.00	0.10	6.00	19.00	75.0	4	32.00	4.60
S7686.0	6.00	0.10	6.00	25.00	75.0	4	32.00	5.50
S7688.0	8.00	0.20	8.00	30.00	75.0	4	38.00	7.40
S76810.0	10.00	0.20	10.00	40.00	100.0	4	50.00	9.20
S76812.0	12.00	0.30	12.00	45.00	100.0	4	55.00	11.00
S76816.0	16.00	0.30	16.00	65.00	125.0	4	75.00	15.00
S76820.0	20.00	0.30	20.00	65.00	125.0	4	75.00	19.00

S260



Fresa de Metal Duro de 4 Filos

Fresa con longitud de corte corta de 4 filos que proporciona alta rigidez en aplicaciones de perfilado estándar. El recubrimiento AlCrN alarga la vida de la herramienta y mejora el rendimiento al fresar materiales difíciles de mecanizar. La hélice de 40° con paso diferencial reduce vibraciones, maximiza la productividad y aumenta la vida de la herramienta.

HM	N	NOF 4#
	40°	γ 4°
DIN 6335HA	AlCrN	DC h9

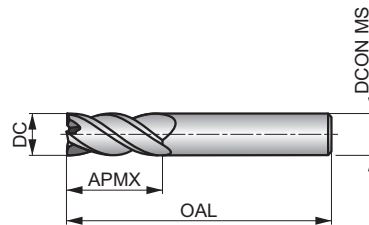

Grupo de Material de la pieza adecuado. Valores de inicio de la velocidad de corte (m/min) y código alfabético. Las tablas con avances por diente y factores de corrección en la pag. 266.

P4.3 ■ 97 J	M2.3 ■ 97 J	M3.3 ■ 99 I	M4.1 ■ 97 I	M4.2 ■ 83 I	S1.3 ■ 70 I	S2.2 ■ 56 I	S3.2 ■ 40 I	S4.2 ■ 32 I	H1.1 ■ 179 I	H2.1 ■ 106 G	H3.1 ■ 118 G	H3.2 ■ 97 G
-----------------------	-----------------------	-----------------------	-----------------------	-----------------------	-----------------------	-----------------------	-----------------------	-----------------------	------------------------	------------------------	------------------------	-----------------------

DCON MS tolerancia h6.

Product	DC (mm)	DCON MS (mm)	APMX (mm)	OAL (mm)	NOF
S2603.0	3.00	6.00	9.00	57.0	4
S2604.0	4.00	6.00	12.00	57.0	4
S2605.0	5.00	6.00	13.00	57.0	4
S2606.0	6.00	6.00	13.00	57.0	4
S2608.0	8.00	8.00	20.00	64.0	4
S26010.0	10.00	10.00	22.00	72.0	4
S26012.0	12.00	12.00	26.00	83.0	4
S26014.0	14.00	14.00	32.00	83.0	4
S26016.0	16.00	16.00	32.00	92.0	4
S26018.0	18.00	18.00	38.00	92.0	4
S26020.0	20.00	20.00	38.00	104.0	4

S262



Fresa de Metal Duro de 4 Filos con Radio de Esquina

Fresa con longitud de corte corta de 4 filos, con diferentes radios de esquina disponibles que proporciona alta rigidez en operaciones de perfilado estándar cuando se requiere un radio. El recubrimiento AlCrN mejora el rendimiento en materiales difíciles de mecanizar. La hélice a 40° con paso diferencial reduce las vibraciones y maximiza la productividad.

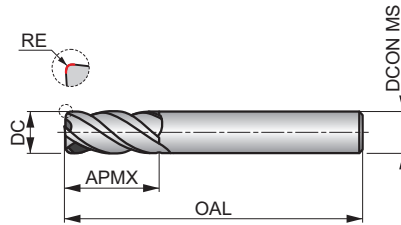

HM	N	NOF 4#
	λ 40°	γ 4°
DIN 6535HA	AlCrN	DC h9

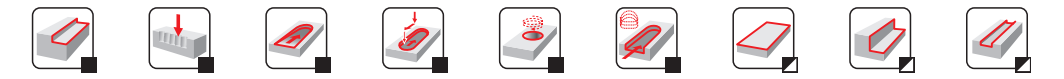

Grupo de Material de la pieza adecuado. Valores de inicio de la velocidad de corte (m/min) y código alfabético. Las tablas con avances por diente y factores de corrección en la pag. 266.

P4.3 ■ 97 J	M2.3 ■ 97 J	M3.3 ■ 99 I	M4.1 ■ 97 I	M4.2 ■ 83 I	S1.3 ■ 70 I	S2.2 ■ 56 I	S3.2 ■ 40 I	S4.2 ■ 32 I	H1.1 ■ 179 I	H2.1 ■ 106 G	H3.1 ■ 118 G	H3.2 ■ 97 G
-----------------------	-----------------------	-----------------------	-----------------------	-----------------------	-----------------------	-----------------------	-----------------------	-----------------------	------------------------	------------------------	------------------------	-----------------------

DCON MS tolerancia h6; RE ±0.01 mm.

Product	DC (mm)	RE (mm)	DCON MS (mm)	APMX (mm)	OAL (mm)	NOF
S2623.0XR0.3	3.00	0.30	6.00	9.00	50.0	4
S2623.0XR0.5	3.00	0.50	6.00	9.00	50.0	4
S2624.0XR0.3	4.00	0.30	6.00	12.00	57.0	4
S2624.0XR0.5	4.00	0.50	6.00	12.00	57.0	4
S2624.0XR1.0	4.00	1.00	6.00	12.00	57.0	4
S2625.0XR0.3	5.00	0.30	6.00	15.00	57.0	4
S2625.0XR0.5	5.00	0.50	6.00	15.00	57.0	4
S2626.0XR0.3	6.00	0.30	6.00	16.00	57.0	4
S2626.0XR0.5	6.00	0.50	6.00	16.00	57.0	4
S2626.0XR1.0	6.00	1.00	6.00	16.00	57.0	4
S2628.0XR0.3	8.00	0.30	8.00	20.00	64.0	4
S2628.0XR0.5	8.00	0.50	8.00	20.00	64.0	4
S2628.0XR1.0	8.00	1.00	8.00	20.00	64.0	4
S2628.0XR1.5	8.00	1.50	8.00	20.00	64.0	4
S2628.0XR2.0	8.00	2.00	8.00	20.00	64.0	4
S26210.0XR0.3	10.00	0.30	10.00	22.00	72.0	4
S26210.0XR0.5	10.00	0.50	10.00	22.00	72.0	4
S26210.0XR1.0	10.00	1.00	10.00	22.00	72.0	4
S26210.0XR1.5	10.00	1.50	10.00	22.00	72.0	4
S26210.0XR2.0	10.00	2.00	10.00	22.00	72.0	4
S26212.0XR0.3	12.00	0.30	12.00	26.00	83.0	4
S26212.0XR0.5	12.00	0.50	12.00	26.00	83.0	4
S26212.0XR1.0	12.00	1.00	12.00	26.00	83.0	4
S26212.0XR2.0	12.00	2.00	12.00	26.00	83.0	4
S26212.0XR2.5	12.00	2.50	12.00	26.00	83.0	4
S26212.0XR3.0	12.00	3.00	12.00	26.00	83.0	4
S26214.0XR0.3	14.00	0.30	14.00	32.00	83.0	4
S26214.0XR0.5	14.00	0.50	14.00	32.00	83.0	4
S26214.0XR1.0	14.00	1.00	14.00	32.00	83.0	4
S26214.0XR2.0	14.00	2.00	14.00	32.00	83.0	4
S26214.0XR3.0	14.00	3.00	14.00	32.00	83.0	4

Product	DC	RE	DCON MS	APMX	OAL	NOF
	(mm)	(mm)	(mm)	(mm)	(mm)	
S26216.0XR0.3	16.00	0.30	16.00	32.00	92.0	4
S26216.0XR0.5	16.00	0.50	16.00	32.00	92.0	4
S26216.0XR1.0	16.00	1.00	16.00	32.00	92.0	4
S26216.0XR2.0	16.00	2.00	16.00	32.00	92.0	4
S26216.0XR2.5	16.00	2.50	16.00	32.00	92.0	4
S26216.0XR3.0	16.00	3.00	16.00	32.00	92.0	4
S26216.0XR4.0	16.00	4.00	16.00	32.00	92.0	4
S26218.0XR0.3	18.00	0.30	18.00	38.00	92.0	4
S26218.0XR0.5	18.00	0.50	18.00	38.00	92.0	4
S26218.0XR1.0	18.00	1.00	18.00	38.00	92.0	4
S26218.0XR2.0	18.00	2.00	18.00	38.00	92.0	4
S26218.0XR3.0	18.00	3.00	18.00	38.00	92.0	4
S26220.0XR0.3	20.00	0.30	20.00	38.00	104.0	4
S26220.0XR0.5	20.00	0.50	20.00	38.00	104.0	4
S26220.0XR1.0	20.00	1.00	20.00	38.00	104.0	4
S26220.0XR2.0	20.00	2.00	20.00	38.00	104.0	4
S26220.0XR2.5	20.00	2.50	20.00	38.00	104.0	4
S26220.0XR3.0	20.00	3.00	20.00	38.00	104.0	4
S26220.0XR4.0	20.00	4.00	20.00	38.00	104.0	4

S219



Fresa de Metal Duro de 4 Filos, Largo Alcance

Fresa con longitud de corte extra corta de 4 filos, que proporciona alta rigidez para el fresado y perfilado en áreas de difícil acceso. Cuello rebajado para evitar el contacto con la pared de la pieza. El recubrimiento AlTiN alarga la vida de la herramienta y mejora el rendimiento al fresar materiales difíciles de mecanizar. El ángulo de hélice de 40° está diseñado para fresado de alto rendimiento.

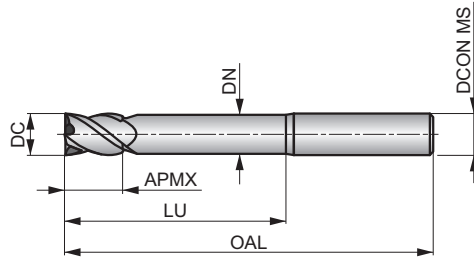

HM	N	NOF 4
	40°	3°
DIN 6535HA	AlTiN	DC h9



Grupo de Material de la pieza adecuado. Valores de inicio de la velocidad de corte (m/min) y código alfabético. Las tablas con avances por diente y factores de corrección en la pag. 266.

- P4.3** ■ 64 J
- M2.3** ■ 64 J
- M3.3** ■ 65 I
- M4.1** ■ 64 I
- M4.2** ■ 54 I
- S1.3** ■ 46 I
- S2.2** ■ 38 I
- S3.2** ■ 26 I
- S4.2** ■ 22 I

DCON MS tolerancia h6.



Product	DC (mm)	DCON MS (mm)	APMX (mm)	OAL (mm)	NOF	LU (mm)	DN (mm)
S2193.0	3.00	3.00	5.00	60.0	4	30.00	2.80
S2194.0	4.00	4.00	8.00	60.0	4	32.00	3.70
S2195.0	5.00	5.00	9.00	60.0	4	32.00	4.60
S2196.0	6.00	6.00	10.00	75.0	4	40.00	5.50
S2198.0	8.00	8.00	12.00	75.0	4	40.00	7.40
S21910.0	10.00	10.00	14.00	75.0	4	40.00	9.20
S21912.0	12.00	12.00	16.00	100.0	4	60.00	11.00
S21914.0	14.00	14.00	22.00	125.0	4	85.00	13.00
S21916.0	16.00	16.00	22.00	125.0	4	85.00	15.00
S21918.0	18.00	18.00	26.00	125.0	4	85.00	17.00
S21920.0	20.00	20.00	26.00	125.0	4	85.00	19.00

S612



Fresa de Metal Duro de 4 Filos

Fresa con longitud de corte corta de 4 filos que proporciona alta rigidez en aplicaciones de perfilado estándar. El recubrimiento Diamante alarga la vida de la herramienta y mejora el rendimiento. Para fresado de materiales abrasivos.

HM	N	NOF 4
	λ 40°	γ 10°
DIN 6358A	Diamond	DC h9
	DORMER	

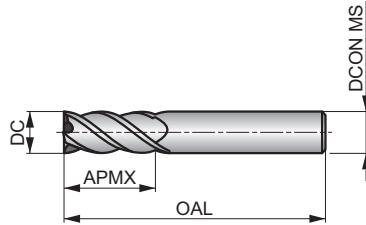

Grupo de Material de la pieza adecuado. Valores de inicio de la velocidad de corte (m/min) y código alfabético. Las tablas con avances por diente y factores de corrección en la pag. 266.

N5.1

■ 350 G

DCON MS tolerancia h6.

Product	DC (mm)	DCON MS (mm)	APMX (mm)	OAL (mm)	NOF
S6121.0	1.00	3.00	3.00	50.0	4
S6121.5	1.50	3.00	4.50	50.0	4
S6122.0	2.00	3.00	6.50	50.0	4
S6122.5	2.50	3.00	6.50	50.0	4
S6123.0	3.00	3.00	9.00	50.0	4
S6124.0	4.00	4.00	12.00	50.0	4
S6125.0	5.00	5.00	15.00	50.0	4
S6126.0	6.00	6.00	20.00	60.0	4
S6128.0	8.00	8.00	20.00	64.0	4
S61210.0	10.00	10.00	22.00	70.0	4
S61212.0	12.00	12.00	25.00	75.0	4

S662



Fresa de Metal Duro de 4 Filos con Radio de Esquina

Fresa con longitud de corte corta de 4 filos, con paso diferencial y diferentes radios de esquina disponibles para operaciones de contorno donde se requiere un radio. La S662, con geometría super positiva, está diseñada para el mecanizado de alto rendimiento de materiales no ferreos.

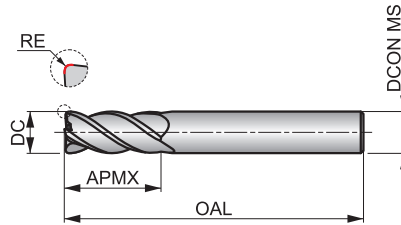

HM	W	NOF 4#
	λ 40°	γ 10°
DIN 6535HA	Bright	DC h9

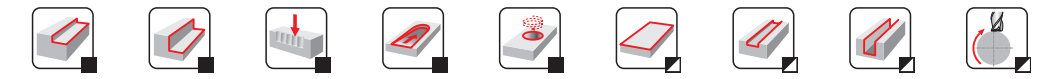

Grupo de Material de la pieza adecuado. Valores de inicio de la velocidad de corte (m/min) y código alfabético. Las tablas con avances por diente y factores de corrección en la pag. 266.

N1.1 ■ 709 0	N1.2 ■ 533 0	N1.3 ■ 357 0	N2.1 ■ 357 N	N2.2 ■ 320 N	N2.3 ■ 229 N	N3.1 ■ 373 N	N3.2 ■ 219 N	N3.3 ■ 112 N	N4.1 ■ 373 P	N4.2 ■ 144 P
------------------------	------------------------	------------------------	------------------------	------------------------	------------------------	------------------------	------------------------	------------------------	------------------------	------------------------

DCON MS tolerancia h6; RE ±0.01 mm.

Product	DC (mm)	RE (mm)	DCON MS (mm)	APMX (mm)	OAL (mm)	NOF
S6623.0XR0.3	3.00	0.30	6.00	9.00	57.0	4
S6624.0XR0.3	4.00	0.30	6.00	12.00	57.0	4
S6624.0XR0.5	4.00	0.50	6.00	12.00	57.0	4
S6625.0XR0.3	5.00	0.30	6.00	15.00	57.0	4
S6625.0XR0.5	5.00	0.50	6.00	15.00	57.0	4
S6626.0XR0.5	6.00	0.50	6.00	16.00	57.0	4
S6626.0XR1.0	6.00	1.00	6.00	16.00	57.0	4
S6626.0XR2.0	6.00	2.00	6.00	16.00	57.0	4
S6628.0XR0.5	8.00	0.50	8.00	20.00	64.0	4
S6628.0XR1.0	8.00	1.00	8.00	20.00	64.0	4
S6628.0XR2.0	8.00	2.00	8.00	20.00	64.0	4
S66210.0XR0.5	10.00	0.50	10.00	22.00	72.0	4
S66210.0XR1.0	10.00	1.00	10.00	22.00	72.0	4
S66210.0XR2.0	10.00	2.00	10.00	22.00	72.0	4
S66212.0XR1.0	12.00	1.00	12.00	26.00	83.0	4
S66212.0XR2.0	12.00	2.00	12.00	26.00	83.0	4
S66212.0XR2.5	12.00	2.50	12.00	26.00	83.0	4
S66212.0XR3.0	12.00	3.00	12.00	26.00	83.0	4
S66216.0XR1.0	16.00	1.00	16.00	32.00	92.0	4
S66216.0XR2.0	16.00	2.00	16.00	32.00	92.0	4
S66216.0XR3.0	16.00	3.00	16.00	32.00	92.0	4
S66216.0XR4.0	16.00	4.00	16.00	32.00	92.0	4
S66220.0XR2.0	20.00	2.00	20.00	38.00	104.0	4
S66220.0XR4.0	20.00	4.00	20.00	38.00	104.0	4

S521



Fresa de Metal Duro de 4 Filos con Radio de Esquina

Fresa con longitud de corte extra corta de 4 fillos, con diferentes radios de esquina disponibles y cuello reducido que proporciona alta rigidez para el contornoado cuando se requiere un radio. El recubrimiento TiSiN mejora el rendimiento y la hélice a 45° está diseñada para el mecanizado de alto rendimiento en materiales endurecidos hasta 63 HRC.

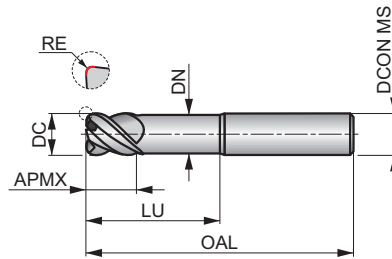

HM	N	NOF 4
	λ 45°	γ -10°
DIN 6535HA	TiSiN	DC h9

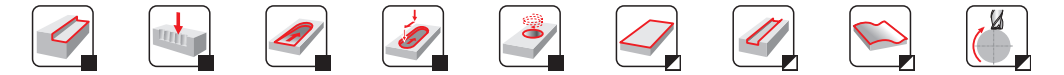

Grupo de Material de la pieza adecuado. Valores de inicio de la velocidad de corte (m/min) y código alfabético. Las tablas con avances por diente y factores de corrección en la pag. 266.

H1.1	H2.1	H2.2	H3.1	H3.2	H4.1	H4.2
■ 119 I	■ 70 G	■ 60 E	■ 78 G	■ 64 G	■ 50 E	■ 42 B

DCON MS tolerancia h6; RE ±0.01 mm.

Product	DC (mm)	RE (mm)	DCON MS (mm)	APMX (mm)	OAL (mm)	NOF	LU (mm)	DN (mm)
S5213.0XR0.3	3.00	0.30	6.00	4.00	60.0	4	14.00	2.80
S5214.0XR0.3	4.00	0.30	6.00	5.00	60.0	4	16.00	3.70
S5214.0XR0.5	4.00	0.50	6.00	5.00	60.0	4	16.00	3.70
S5215.0XR0.3	5.00	0.30	6.00	6.00	60.0	4	18.00	4.60
S5215.0XR0.5	5.00	0.50	6.00	6.00	60.0	4	18.00	4.60
S5216.0XR0.5	6.00	0.50	6.00	7.00	60.0	4	20.00	5.50
S5216.0XR1.0	6.00	1.00	6.00	7.00	60.0	4	20.00	5.50
S5218.0XR0.5	8.00	0.50	8.00	9.00	64.0	4	26.00	7.40
S5218.0XR1.0	8.00	1.00	8.00	9.00	64.0	4	26.00	7.40
S52110.0XR1.0	10.00	1.00	10.00	11.00	70.0	4	31.00	9.20
S52110.0XR2.0	10.00	2.00	10.00	11.00	70.0	4	31.00	9.20
S52112.0XR1.0	12.00	1.00	12.00	13.00	75.0	4	37.00	11.00
S52112.0XR2.0	12.00	2.00	12.00	13.00	75.0	4	37.00	11.00
S52116.0XR1.0	16.00	1.00	16.00	17.00	90.0	4	43.00	15.00
S52116.0XR2.0	16.00	2.00	16.00	17.00	90.0	4	43.00	15.00
S52116.0XR3.0	16.00	3.00	16.00	17.00	90.0	4	43.00	15.00

S523



Fresa de Metal Duro de 4 Filos con Radio de Esquina

Fresa con longitud de corte corta de 4 filos, con diferentes radios de esquina disponibles que proporciona alta rigidez para el perfilado estándar donde se requiere un radio. El recubrimiento TiSiN mejora el rendimiento y la hélice a 40° está diseñada para el mecanizado de alto rendimiento en materiales endurecidos hasta 63 HRC.

HM	N	NOF 4
	λ 40°	γ -6°
DIN 6535HA	TiSiN	DC h9
	DORMER	

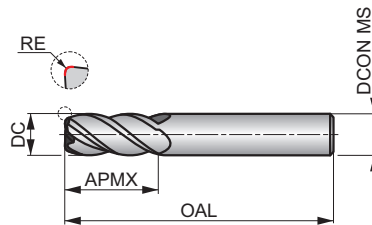

Grupo de Material de la pieza adecuado. Valores de inicio de la velocidad de corte (m/min) y código alfabético. Las tablas con avances por diente y factores de corrección en la pag. 266.

H1.1	H2.1	H2.2	H3.1	H3.2	H4.1	H4.2
■ 119 I	■ 70 G	■ 60 E	■ 78 G	■ 64 G	■ 50 E	■ 42 B

DCON MS tolerancia h6; RE ±0.01 mm.

Product	DC (mm)	RE (mm)	DCON MS (mm)	APMX (mm)	OAL (mm)	NOF
S5231.5XR0.2	1.50	0.20	6.00	4.50	50.0	4
S5232.0XR0.2	2.00	0.20	6.00	6.50	50.0	4
S5233.0XR0.2XD3	3.00	0.20	3.00	9.00	50.0	4
S5233.0XR0.3XD3	3.00	0.30	3.00	9.00	50.0	4
S5233.0XR0.2XD6	3.00	0.20	6.00	9.00	50.0	4
S5233.0XR0.3XD6	3.00	0.30	6.00	9.00	50.0	4
S5233.0XR0.5XD6	3.00	0.50	6.00	9.00	50.0	4
S5234.0XR0.3XD4	4.00	0.30	4.00	12.00	50.0	4
S5234.0XR0.5XD4	4.00	0.50	4.00	12.00	50.0	4
S5234.0XR0.3XD6	4.00	0.30	6.00	12.00	50.0	4
S5234.0XR0.5XD6	4.00	0.50	6.00	12.00	50.0	4
S5235.0XR0.3XD5	5.00	0.30	5.00	15.00	50.0	4
S5235.0XR0.5XD5	5.00	0.50	5.00	15.00	50.0	4
S5235.0XR0.3XD6	5.00	0.30	6.00	15.00	50.0	4
S5235.0XR0.5XD6	5.00	0.50	6.00	15.00	50.0	4
S5236.0XR0.3	6.00	0.30	6.00	16.00	50.0	4
S5236.0XR0.5	6.00	0.50	6.00	16.00	50.0	4
S5236.0XR1.0	6.00	1.00	6.00	16.00	50.0	4
S5238.0XR0.3	8.00	0.30	8.00	20.00	64.0	4
S5238.0XR0.5	8.00	0.50	8.00	20.00	64.0	4
S5238.0XR1.0	8.00	1.00	8.00	20.00	64.0	4
S5238.0XR2.0	8.00	2.00	8.00	20.00	64.0	4
S52310.0XR0.5	10.00	0.50	10.00	22.00	70.0	4
S52310.0XR1.0	10.00	1.00	10.00	22.00	70.0	4
S52310.0XR1.5	10.00	1.50	10.00	22.00	70.0	4
S52310.0XR2.0	10.00	2.00	10.00	22.00	70.0	4
S52312.0XR0.5	12.00	0.50	12.00	25.00	75.0	4
S52312.0XR1.0	12.00	1.00	12.00	25.00	75.0	4
S52312.0XR2.0	12.00	2.00	12.00	25.00	75.0	4
S52312.0XR3.0	12.00	3.00	12.00	25.00	75.0	4
S52316.0XR0.5	16.00	0.50	16.00	32.00	90.0	4



Product	DC	RE	DCON MS	APMX	OAL	NOF
	(mm)	(mm)	(mm)	(mm)	(mm)	
S52316.0XR1.0	16.00	1.00	16.00	32.00	90.0	4
S52316.0XR2.0	16.00	2.00	16.00	32.00	90.0	4
S52316.0XR3.0	16.00	3.00	16.00	32.00	90.0	4

S524



Fresa de Metal Duro de 4 Filos con Radio de Esquina, Largo Alcance

Fresa con longitud de corte extra corta de 4 filos, con diferentes radios de esquina disponibles y hélice de 40° que proporciona alta rigidez para el perfilado de áreas de difícil acceso donde se requiere un radio. Cuello reducido para evitar el contacto con la pared de la pieza. El recubrimiento TiSiN aumenta la vida útil y mejora el rendimiento al fresar materiales endurecidos hasta 63 HRC.

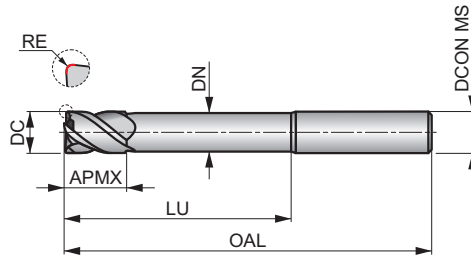

HM	N	NOF 4
	40°	γ -6°
DIN 6535HA	TiSiN	DC h9

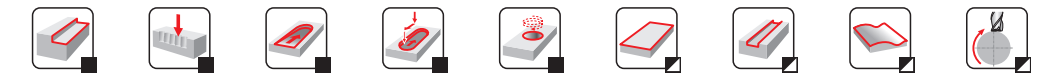

Grupo de Material de la pieza adecuado. Valores de inicio de la velocidad de corte (m/min) y código alfabético. Las tablas con avances por diente y factores de corrección en la pag. 266.

H1.1 ■ 119 I	H2.1 ■ 70 G	H2.2 ■ 60 E	H3.1 ■ 78 G	H3.2 ■ 64 G	H4.1 ■ 50 E	H4.2 ■ 42 B
------------------------	-----------------------	-----------------------	-----------------------	-----------------------	-----------------------	-----------------------

DCON MS tolerancia h6; RE ±0.01 mm.

Product	DC (mm)	RE (mm)	DCON MS (mm)	APMX (mm)	OAL (mm)	NOF	LU (mm)	DN (mm)
S5243.0XR0.3	3.00	0.30	6.00	5.00	75.0	4	30.00	2.80
S5244.0XR0.3	4.00	0.30	6.00	8.00	75.0	4	32.00	3.70
S5244.0XR0.5	4.00	0.50	6.00	8.00	75.0	4	32.00	3.70
S5245.0XR0.3	5.00	0.30	6.00	9.00	75.0	4	32.00	4.60
S5245.0XR0.5	5.00	0.50	6.00	9.00	75.0	4	32.00	4.60
S5246.0XR0.3	6.00	0.30	6.00	10.00	75.0	4	40.00	5.50
S5246.0XR0.5	6.00	0.50	6.00	10.00	75.0	4	40.00	5.50
S5246.0XR1.0	6.00	1.00	6.00	10.00	75.0	4	40.00	5.50
S5248.0XR0.3	8.00	0.30	8.00	12.00	75.0	4	40.00	7.40
S5248.0XR0.5	8.00	0.50	8.00	12.00	75.0	4	40.00	7.40
S5248.0XR1.0	8.00	1.00	8.00	12.00	75.0	4	40.00	7.40
S52410.0XR0.5	10.00	0.50	10.00	14.00	75.0	4	40.00	9.20
S52410.0XR1.0	10.00	1.00	10.00	14.00	75.0	4	40.00	9.20
S52410.0XR2.0	10.00	2.00	10.00	14.00	75.0	4	40.00	9.20
S52412.0XR0.5	12.00	0.50	12.00	16.00	100.0	4	60.00	11.00
S52412.0XR1.0	12.00	1.00	12.00	16.00	100.0	4	60.00	11.00
S52412.0XR2.0	12.00	2.00	12.00	16.00	100.0	4	60.00	11.00
S52416.0XR0.5	16.00	0.50	16.00	22.00	125.0	4	85.00	15.00
S52416.0XR1.0	16.00	1.00	16.00	22.00	125.0	4	85.00	15.00
S52416.0XR2.0	16.00	2.00	16.00	22.00	125.0	4	85.00	15.00
S52416.0XR3.0	16.00	3.00	16.00	22.00	125.0	4	85.00	15.00

S561

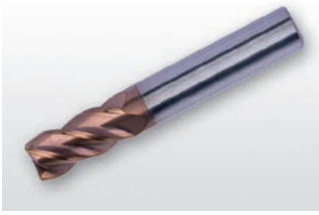

Fresa de Metal Duro de 4 Filos

Fresa con longitud de corte media de 4 filos con hélice de 40° y refuerzo en el filo, que permite fresar materiales endurecidos hasta 70 HRC. El recubrimiento TiSiN aumenta la vida útil y mejora el rendimiento y el paso diferencial reduce vibraciones, maximizando la productividad y la vida de la herramienta. Diseño sin radios para producir esquinas vivas.

HM	N	NOF 4#
	λ 40°	γ -6°
DIN 6535HA	TiSiN	DC h9
	DORMER	

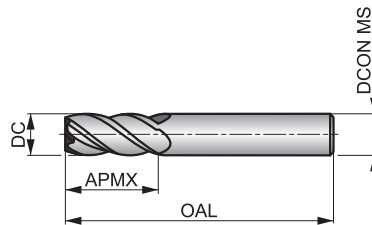

Grupo de Material de la pieza adecuado. Valores de inicio de la velocidad de corte (m/min) y código alfabético. Las tablas con avances por diente y factores de corrección en la pag. 266.

H1.1	H2.1	H2.2	H3.1	H3.2	H4.1	H4.2
■ 119 I	■ 70 G	■ 60 E	■ 78 G	■ 64 G	■ 50 E	■ 42 B

DCON MS tolerancia h6.

Product	DC (mm)	DCON MS (mm)	APMX (mm)	OAL (mm)	NOF
S5611.0	1.00	6.00	3.00	50.0	4
S5611.5	1.50	6.00	4.50	50.0	4
S5612.0	2.00	6.00	6.50	50.0	4
S5612.5	2.50	6.00	6.50	50.0	4
S5613.0	3.00	6.00	9.00	50.0	4
S5614.0	4.00	6.00	12.00	50.0	4
S5615.0	5.00	6.00	15.00	50.0	4
S5616.0	6.00	6.00	20.00	60.0	4
S5618.0	8.00	8.00	20.00	64.0	4
S56110.0	10.00	10.00	22.00	70.0	4
S56112.0	12.00	12.00	25.00	75.0	4
S56114.0	14.00	14.00	32.00	90.0	4
S56116.0	16.00	16.00	32.00	90.0	4
S56118.0	18.00	18.00	38.00	100.0	4
S56120.0	20.00	20.00	38.00	100.0	4

Código de Material (BMC)	HM	HM	HM	HM	HM	HM							
Perfil de la fresa	N	N	N	N	N	N							
Número de canales (NOF)													
Longitud de corte													
Ángulo de hélice (FHA)	λ 50°	λ 50°	λ 50°	λ 50°	λ 50°	λ 50°							
Ángulo de hélice (FHA)	λ 50°	λ 50°	λ 50°	λ 50°	λ 50°	λ 50°							
Ángulo de incidencia radial (GAMF)	γ 3°	γ 3°	γ 3°	γ -26°	γ -26°	γ -26°							
Mango													
Recubrimiento													
Clase de tolerancia del diámetro de corte (TCDC)	DC h9	DC h9	DC h9	DC h9	DC h9	DC h9							
Dirección													
Grupo básico estándar (BSG)													



Código de Familia de Producto	S225	S226	S227	S525	S526	S527							
Gama de diámetros de corte PSF	3.00 – 20.00	3.00 – 20.00	6.00 – 20.00	3.00 – 20.00	3.00 – 20.00	3.00 – 20.00							
	146	147	148	149	150	151							

P	P1												
	P2												
	P3												
	P4	<input checked="" type="checkbox"/>	<input checked="" type="checkbox"/>	<input checked="" type="checkbox"/>									
M	M1												
	M2	<input checked="" type="checkbox"/>	<input checked="" type="checkbox"/>	<input checked="" type="checkbox"/>									
	M3	<input checked="" type="checkbox"/>	<input checked="" type="checkbox"/>	<input checked="" type="checkbox"/>									
	M4	<input checked="" type="checkbox"/>	<input checked="" type="checkbox"/>	<input checked="" type="checkbox"/>									
K	K1												
	K2												
	K3												
	K4												
	K5												
N	N1												
	N2												
	N3												
	N4												
	N5												
S	S1	<input checked="" type="checkbox"/>	<input checked="" type="checkbox"/>	<input checked="" type="checkbox"/>									
	S2	<input checked="" type="checkbox"/>	<input checked="" type="checkbox"/>	<input checked="" type="checkbox"/>									
	S3	<input checked="" type="checkbox"/>	<input checked="" type="checkbox"/>	<input checked="" type="checkbox"/>									
	S4	<input checked="" type="checkbox"/>	<input checked="" type="checkbox"/>	<input checked="" type="checkbox"/>									
H	H1				<input checked="" type="checkbox"/>	<input checked="" type="checkbox"/>	<input checked="" type="checkbox"/>						
	H2				<input checked="" type="checkbox"/>	<input checked="" type="checkbox"/>	<input checked="" type="checkbox"/>						
	H3				<input checked="" type="checkbox"/>	<input checked="" type="checkbox"/>	<input checked="" type="checkbox"/>						
	H4				<input checked="" type="checkbox"/>	<input checked="" type="checkbox"/>	<input checked="" type="checkbox"/>						

S225



Fresa de Metal Duro de Múltiples Filos para Acabado

Fresa con longitud de corte corta de 6 o 8 filos que proporciona alta rigidez en aplicaciones de acabado de paredes profundas. Cuello rebajado para evitar el contacto con la pared de la pieza. El recubrimiento AlTiN prolonga la vida de la herramienta y mejora el rendimiento al fresar materiales difíciles de mecanizar. La hélice a 50° está diseñada para dejar un acabado superficial de alta calidad.

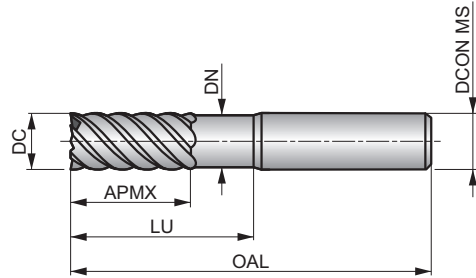

HM	N	NOF 6-8
	λ 50°	γ 3°
DIN 6335HA	AlTiN	DC h9



Grupo de Material de la pieza adecuado. Valores de inicio de la velocidad de corte (m/min) y código alfabético. Las tablas con avances por diente y factores de corrección en la pag. 266.

P4.3	M2.3	M3.3	M4.1	M4.2	S1.3	S2.2	S3.2	S4.2
■ 80 G	■ 80 G	■ 82 F	■ 80 F	■ 68 F	■ 58 F	■ 47 F	■ 33 F	■ 27 F

DCON MS tolerancia h6.

Product	DC (mm)	DCON MS (mm)	APMX (mm)	OAL (mm)	NOF	LU (mm)	DN (mm)
S2253.0	3.00	6.00	8.00	50.0	6	20.00	2.80
S2254.0	4.00	6.00	11.00	50.0	6	20.00	3.70
S2256.0	6.00	6.00	15.00	50.0	6	20.00	5.50
S2258.0	8.00	8.00	20.00	64.0	6	30.00	7.40
S22510.0	10.00	10.00	22.00	70.0	6	32.00	9.20
S22512.0	12.00	12.00	25.00	75.0	6	37.00	11.00
S22514.0	14.00	14.00	30.00	90.0	6	44.00	13.00
S22516.0	16.00	16.00	30.00	90.0	8	46.00	15.00
S22518.0	18.00	18.00	35.00	100.0	8	53.00	17.00
S22520.0	20.00	20.00	38.00	100.0	8	58.00	19.00

S226



Fresa de Metal Duro de Múltiples Filos para Acabado, Serie Larga

Fresa con longitud de corte larga de 6 o 8 filos que proporciona alta rigidez en aplicaciones de acabado de paredes profundas. Cuello rebajado para evitar el contacto con la pared de la pieza. El recubrimiento AlTiN alarga la vida de la herramienta y mejora el rendimiento al fresar materiales difíciles de mecanizar. La hélice a 50° está diseñada para dejar un acabado superficial de alta calidad.

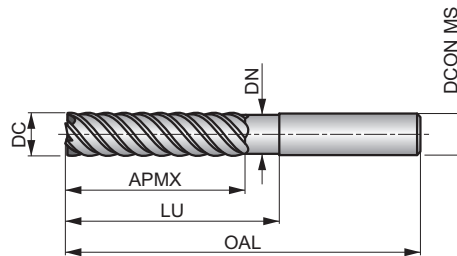

HM	N	NOF 6-8
	λ 50°	γ 3°
DIN 6335HA	AlTiN	DC h9
	DORMER	



Grupo de Material de la pieza adecuado. Valores de inicio de la velocidad de corte (m/min) y código alfabético. Las tablas con avances por diente y factores de corrección en la pag. 266.

- P4.3**
■ 64 G
- M2.3**
■ 64 G
- M3.3**
■ 65 F
- M4.1**
■ 64 F
- M4.2**
■ 54 F
- S1.3**
■ 46 F
- S2.2**
■ 38 F
- S3.2**
■ 26 F
- S4.2**
■ 22 F

DCON MS tolerancia h6.

Product	DC (mm)	DCON MS (mm)	APMX (mm)	OAL (mm)	NOF	LU (mm)	DN (mm)
S2263.0	3.00	6.00	19.00	75.0	6	30.00	2.80
S2264.0	4.00	6.00	19.00	75.0	6	32.00	3.70
S2266.0	6.00	6.00	31.00	75.0	6	40.00	5.50
S2268.0	8.00	8.00	31.00	75.0	6	40.00	7.40
S22610.0	10.00	10.00	45.00	100.0	6	60.00	9.20
S22612.0	12.00	12.00	50.00	100.0	6	60.00	11.00
S22614.0	14.00	14.00	57.00	125.0	6	85.00	13.00
S22616.0	16.00	16.00	57.00	125.0	8	85.00	15.00
S22618.0	18.00	18.00	57.00	125.0	8	85.00	17.00
S22620.0	20.00	20.00	57.00	125.0	8	85.00	19.00

S227



Fresa de Metal Duro de Múltiples Filos para acabado, Serie Extra Larga

Fresa con longitud de corte extra larga de 6 o 8 filos que proporciona alta rigidez en aplicaciones de acabado de paredes muy profundas. Cuello rebajado para evitar el contacto con la pared de la pieza. El recubrimiento AlTiN alarga la vida de la herramienta y mejora el rendimiento al fresar materiales difíciles de mecanizar. La hélice a 50° está diseñada para dejar un acabado superficial de alta calidad.

HM	N	NOF 6-8
	λ 50°	γ 3°
DIN 6535HA	AlTiN	DC h9
	DORMER	

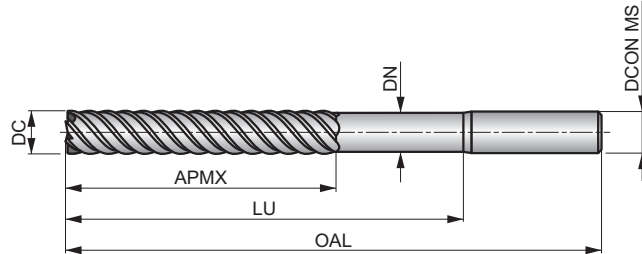

Grupo de Material de la pieza adecuado. Valores de inicio de la velocidad de corte (m/min) y código alfabético. Las tablas con avances por diente y factores de corrección en la pag. 266.

- P4.3**
■ 40 G
- M2.3**
■ 40 G
- M3.3**
■ 41 F
- M4.1**
■ 40 F
- M4.2**
■ 34 F
- S1.3**
■ 29 F
- S2.2**
■ 24 F
- S3.2**
■ 17 F
- S4.2**
■ 14 F

DCON MS tolerancia h6.

Product	DC (mm)	DCON MS (mm)	APMX (mm)	OAL (mm)	NOF	LU (mm)	DN (mm)
S2276.0	6.00	6.00	38.00	100.0	6	60.00	5.50
S2278.0	8.00	8.00	41.00	100.0	6	60.00	7.40
S22710.0	10.00	10.00	57.00	125.0	6	85.00	9.20
S22712.0	12.00	12.00	75.00	150.0	6	110.00	11.00
S22714.0	14.00	14.00	75.00	150.0	6	110.00	13.00
S22716.0	16.00	16.00	75.00	150.0	8	110.00	15.00
S22718.0	18.00	18.00	75.00	150.0	8	110.00	17.00
S22720.0	20.00	20.00	75.00	150.0	8	110.00	19.00

S525



Fresa de Metal Duro de Múltiples Filos para Acabado

Fresa con longitud de corte corta de 6 o 8 filos con hélice a 50° que proporciona alta rigidez para el acabado de paredes profundas. Cuello reducido para evitar el contacto con la pieza. El recubrimiento TiSiN aumenta la vida útil y mejora el rendimiento al fresar materiales endurecidos hasta 63 HRC.

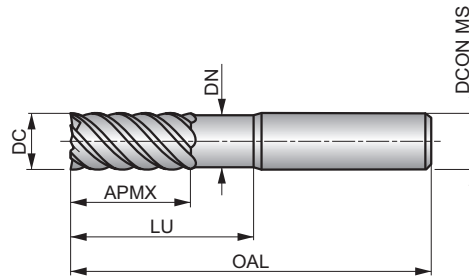

HM	N	NOF 6-8
	λ 50°	γ -26°
DIN 6335HA	TiSiN	DC h9



Grupo de Material de la pieza adecuado. Valores de inicio de la velocidad de corte (m/min) y código alfabético. Las tablas con avances por diente y factores de corrección en la pag. 266.

H1.1	H2.1	H2.2	H3.1	H3.2	H4.1	H4.2
■ 119 G	■ 70 G	■ 60 E	■ 78 G	■ 64 G	■ 50 E	■ 42 A

DCON MS tolerancia h6.

Product	DC (mm)	DCON MS (mm)	APMX (mm)	OAL (mm)	NOF	LU (mm)	DN (mm)
S5253.0	3.00	6.00	8.00	50.0	6	20.00	2.80
S5254.0	4.00	6.00	11.00	50.0	6	20.00	3.70
S5256.0	6.00	6.00	15.00	50.0	6	20.00	5.50
S5258.0	8.00	8.00	20.00	64.0	6	30.00	7.40
S52510.0	10.00	10.00	22.00	70.0	6	32.00	9.20
S52512.0	12.00	12.00	25.00	75.0	6	37.00	11.00
S52514.0	14.00	14.00	30.00	90.0	6	44.00	13.00
S52516.0	16.00	16.00	30.00	90.0	8	46.00	15.00
S52518.0	18.00	18.00	35.00	100.0	8	53.00	17.00
S52520.0	20.00	20.00	38.00	100.0	8	58.00	19.00

S526



Fresa de Metal Duro de Múltiples Filos para Acabado, Serie Larga

Fresa con longitud de corte larga de 6 o 8 filos con hélice a 50° que proporciona alta rigidez para el acabado de paredes profundas. Cuello reducido para evitar el contacto con la pieza. El recubrimiento TiSiN aumenta la vida útil y mejora el rendimiento al fresar materiales endurecidos hasta 63 HRC.

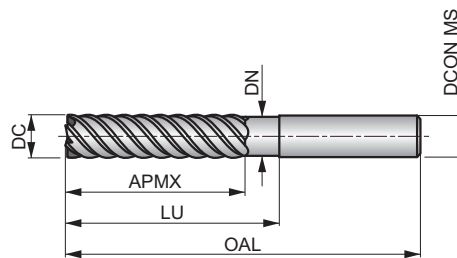

HM	N	NOF 6-8
	λ 50°	γ -26°
DIN 6335HA	TiSiN	DC h9



Grupo de Material de la pieza adecuado. Valores de inicio de la velocidad de corte (m/min) y código alfabético. Las tablas con avances por diente y factores de corrección en la pag. 266.

H1.1 ■ 96 G	H2.1 ■ 57 G	H2.2 ■ 49 E	H3.1 ■ 63 G	H3.2 ■ 52 G	H4.1 ■ 40 E	H4.2 ■ 34 A
-----------------------	-----------------------	-----------------------	-----------------------	-----------------------	-----------------------	-----------------------

DCON MS tolerancia h6.

Product	DC (mm)	DCON MS (mm)	APMX (mm)	OAL (mm)	NOF	LU (mm)	DN (mm)
S5263.0	3.00	6.00	19.00	75.0	6	30.00	2.80
S5264.0	4.00	6.00	19.00	75.0	6	32.00	3.70
S5266.0	6.00	6.00	31.00	75.0	6	40.00	5.50
S5268.0	8.00	8.00	31.00	75.0	6	40.00	7.40
S52610.0	10.00	10.00	45.00	100.0	6	60.00	9.20
S52612.0	12.00	12.00	50.00	100.0	6	60.00	11.00
S52614.0	14.00	14.00	57.00	125.0	6	85.00	13.00
S52616.0	16.00	16.00	57.00	125.0	8	85.00	15.00
S52618.0	18.00	18.00	57.00	125.0	8	85.00	17.00
S52620.0	20.00	20.00	57.00	125.0	8	85.00	19.00

S527



Fresa de Metal Duro de Múltiples Filos para acabado, Serie Extra Larga

Fresa con longitud de corte extra larga de 6 o 8 filos, con ángulo de hélice de 50°, que proporciona alta rigidez en aplicaciones de acabado de paredes muy profundas. Cuello rebajado para evitar el contacto con la pared de la pieza. El recubrimiento TiSiN aumenta la vida útil y mejora el rendimiento al fresar materiales endurecidos hasta 63 HRC.

HM	N	NOF 6-8
	λ 50°	γ -26°
DIN 6535HA	TiSiN	DC h9
	DORMER	

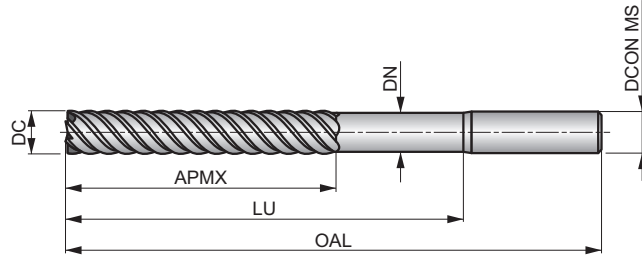

Grupo de Material de la pieza adecuado. Valores de inicio de la velocidad de corte (m/min) y código alfabético. Las tablas con avances por diente y factores de corrección en la pag. 266.

H1.1 ■ 59 G	H2.1 ■ 35 G	H2.2 ■ 30 E	H3.1 ■ 39 G	H3.2 ■ 32 G	H4.1 ■ 25 E	H4.2 ■ 21 A
-----------------------	-----------------------	-----------------------	-----------------------	-----------------------	-----------------------	-----------------------

DCON MS tolerancia h6.

Product	DC (mm)	DCON MS (mm)	APMX (mm)	OAL (mm)	NOF	LU (mm)	DN (mm)
S5273.0	3.00	6.00	25.00	100.0	6	60.00	2.80
S5274.0	4.00	6.00	31.00	100.0	6	60.00	3.70
S5276.0	6.00	6.00	38.00	100.0	6	60.00	5.50
S5278.0	8.00	8.00	41.00	100.0	6	60.00	7.40
S52710.0	10.00	10.00	57.00	125.0	6	85.00	9.20
S52712.0	12.00	12.00	75.00	150.0	6	110.00	11.00
S52716.0	16.00	16.00	75.00	150.0	8	110.00	15.00
S52720.0	20.00	20.00	75.00	150.0	8	110.00	19.00

Código de Material (BMC)	HM	HM	HM	HM	HM	HM	HM	HM	HM	HM	HM	HM
Perfil de la fresa	N	N	N	N	N	W	N	N	N	N	N	N
Número de canales (NOF)	NOF 2	NOF 4	NOF 2	NOF 2	NOF 2	NOF 2	NOF 2	NOF 2	NOF 2	NOF 4	NOF 4	NOF 3-4
Longitud de corte												
Ángulo de hélice (FHA)	λ 30°	λ 30°	λ 30°	λ 30°	λ 30°	λ 30°	λ 30°	λ 30°	λ 30°	λ 30°	λ 30°	λ 30°
Ángulo de hélice (FHA)	λ 30°	λ 30°	λ 30°	λ 30°	λ 30°	λ 30°	λ 30°	λ 30°	λ 30°	λ 30°	λ 30°	λ 30°
Ángulo de incidencia radial (GAMF)	γ 10°	γ 10°	γ 3°	γ 3°	γ 3°	γ 15°	γ -10°	γ -10°	γ -10°	γ -10°	γ -10°	γ 8°
Mango												
Recubrimiento	X-CEED	X-CEED	TISIN	TISIN	TISIN	Bright	TISIN	TISIN	TISIN	TISIN	TISIN	AlCN
Clase de tolerancia del diámetro de corte (TCDC)	DC h9	DC h9	DC h9	DC h9	DC h9	DC h9	DC h9	DC h9	DC h9	DC h9	DC h9	
Dirección												
Grupo básico estándar (BSG)												



Código de Familia de Producto	S501	S511	S229	S231	S233	S629	S529	S531	S533	S534	S535	S791
Gama de diámetros de corte PSF	1.00 – 16.00	3.00 – 16.00	1.50 – 16.00	1.50 – 16.00	2.00 – 16.00	1.00 – 20.00	1.50 – 16.00	1.50 – 16.00	2.00 – 16.00	3.00 – 16.00	3.00 – 16.00	6.00 – 16.00
	154	155	156	157	158	159	160	161	162	163	164	165

P	P1	■	■									■
	P2	■	■									■
	P3	■	■									■
	P4	■	■	☑	☑	☑						
M	M1	■	■									■
	M2	■	■	■	■	■						■
	M3	☑	☑	■	■	■						☑
	M4	☑	☑	■	■	■						☑
K	K1	■	■									■
	K2	■	■									■
	K3	■	■									■
	K4	■	■									■
	K5	■	■									■
N	N1	☑	☑			■						☑
	N2	☑	☑			■						☑
	N3	■	■			■						■
	N4	☑	☑			■						☑
	N5											
S	S1	☑	☑	■	■	■						☑
	S2	☑	☑	■	■	■						☑
	S3	☑	☑	■	■	■						☑
	S4	☑	☑	■	■	■						☑
H	H1						■	■	■	■	■	
	H2						■	■	■	■	■	
	H3						■	■	■	■	■	
	H4						■	■	■	■	■	

S501

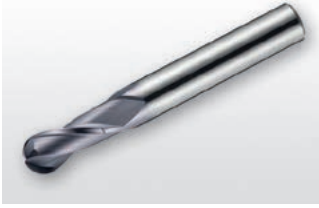

Fresa de Metal Duro de 2 Filos con Punta Esférica

Fresa con longitud de corte corta de 2 filos, diseñada para reducir vibraciones y aumentar la resistencia. Geometría de punta esférica diseñada para el contorneado de alto rendimiento de superficies complejas. El recubrimiento X-CEED mejora el rendimiento en el fresado de materiales difíciles de mecanizar.

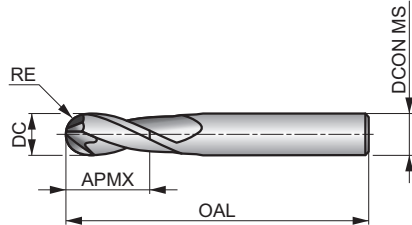

HM	N	NOF 2
	λ 30°	γ 10°
DIN 6535HA	X-CEED	DC h9



Grupo de Material de la pieza adecuado. Valores de inicio de la velocidad de corte (m/min) y código alfabético. Las tablas con avances por diente y factores de corrección en la pag. 266.

P1.1 ■ 161 F	P1.2 ■ 181 F	P1.3 ■ 186 F	P2.1 ■ 138 F	P2.2 ■ 121 F	P2.3 ■ 108 F	P3.1 ■ 112 F	P3.2 ■ 90 F	P3.3 ■ 76 F	P4.1 ■ 66 F	P4.2 ■ 57 F	P4.3 ▣ 46 F	M1.1 ■ 94 F	M1.2 ■ 79 F
M2.1 ■ 83 F	M2.2 ■ 69 F	M3.1 ▣ 77 F	M3.2 ▣ 66 F	M3.3 ▣ 59 E	M4.1 ▣ 58 E	K1.1 ■ 161 F	K1.2 ■ 119 F	K1.3 ■ 89 F	K2.1 ■ 165 F	K2.2 ■ 134 F	K2.3 ■ 107 F	K3.1 ■ 146 F	K3.2 ■ 112 F
K3.3 ■ 90 F	K4.1 ■ 136 F	K4.2 ■ 102 F	K4.3 ■ 75 F	K4.4 ■ 64 E	K4.5 ■ 54 E	K5.1 ■ 154 F	K5.2 ■ 115 F	K5.3 ■ 89 F	N1.1 ▣ 355 G	N1.2 ▣ 267 G	N1.3 ▣ 179 G	N2.1 ▣ 179 F	N2.2 ▣ 160 F
N2.3 ▣ 115 F	N3.1 ■ 187 F	N3.2 ■ 109 F	N3.3 ▣ 56 F	N4.1 ▣ 187 F	N4.2 ▣ 72 F	S1.1 ▣ 126 F	S1.2 ▣ 112 F	S2.1 ▣ 186 E	S3.1 ▣ 65 E	S4.1 ▣ 51 E			

DCON MS tolerancia h6; RE ±0.01 mm.

Product	DC (mm)	RE (mm)	DCON MS (mm)	APMX (mm)	OAL (mm)	NOF
S5011.0	1.00	0.50	3.00	3.00	38.0	2
S5011.5	1.50	0.75	3.00	3.00	38.0	2
S5012.0	2.00	1.00	3.00	6.00	38.0	2
S5012.5	2.50	1.25	3.00	7.00	38.0	2
S5013.0	3.00	1.50	3.00	7.00	38.0	2
S5014.0	4.00	2.00	6.00	8.00	57.0	2
S5015.0	5.00	2.50	6.00	10.00	57.0	2
S5016.0	6.00	3.00	6.00	10.00	57.0	2
S5017.0	7.00	3.50	8.00	13.00	63.0	2
S5018.0	8.00	4.00	8.00	16.00	63.0	2
S5019.0	9.00	4.50	10.00	16.00	72.0	2
S50110.0	10.00	5.00	10.00	19.00	72.0	2
S50112.0	12.00	6.00	12.00	22.00	83.0	2
S50116.0	16.00	8.00	16.00	26.00	92.0	2

S511

DORMER



Fresa de Metal Duro de 4 Filos con Punta Esférica, Alcance Extra Largo

Fresa con longitud de corte corta y alcance extra largo de 4 filos, que proporciona alta rigidez para aumentar la resistencia y reducir vibraciones en aplicaciones profundas. Geometría de punta esférica diseñada para el contorno de alto rendimiento de superficies complejas. El recubrimiento X-CEED mejora el rendimiento en el fresado de materiales difíciles de mecanizar.

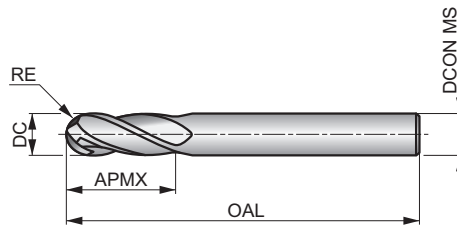

HM	N	NOF 4
	λ 30°	γ 10°
DIN 6335HA	X-CEED	DC h9



Grupo de Material de la pieza adecuado. Valores de inicio de la velocidad de corte (m/min) y código alfabético. Las tablas con avances por diente y factores de corrección en la pag. 266.

P1.1 ■ 161 E	P1.2 ■ 181 E	P1.3 ■ 186 E	P2.1 ■ 138 E	P2.2 ■ 121 E	P2.3 ■ 108 E	P3.1 ■ 112 E	P3.2 ■ 90 E	P3.3 ■ 76 E	P4.1 ■ 66 E	P4.2 ■ 57 E	P4.3 ▣ 46 E	M1.1 ■ 94 E	M1.2 ■ 79 E
M2.1 ■ 83 E	M2.2 ■ 69 E	M3.1 ▣ 77 E	M3.2 ▣ 66 E	M3.3 ▣ 59 D	M4.1 ▣ 58 D	K1.1 ■ 161 E	K1.2 ■ 119 E	K1.3 ■ 89 E	K2.1 ■ 165 E	K2.2 ■ 134 E	K2.3 ■ 107 E	K3.1 ■ 146 E	K3.2 ■ 112 E
K3.3 ■ 90 E	K4.1 ■ 136 E	K4.2 ■ 102 E	K4.3 ■ 75 E	K4.4 ■ 64 D	K4.5 ■ 54 D	K5.1 ■ 154 E	K5.2 ■ 115 E	K5.3 ■ 89 E	N1.1 ▣ 355 F	N1.2 ▣ 267 F	N1.3 ▣ 179 F	N2.1 ▣ 179 E	N2.2 ▣ 160 E
N2.3 ▣ 115 E	N3.1 ■ 187 E	N3.2 ■ 109 E	N3.3 ▣ 56 E	N4.1 ▣ 187 E	N4.2 ▣ 72 E	S1.1 ▣ 126 E	S1.2 ▣ 112 E	S2.1 ▣ 186 D	S3.1 ▣ 65 D	S4.1 ▣ 51 D			

DCON MS tolerancia h6; RE +0/-0.01 mm.

Product	DC (mm)	RE (mm)	DCON MS (mm)	APMX (mm)	OAL (mm)	NOF
S5113.0	3.00	1.50	6.00	8.00	80.0	4
S5114.0	4.00	2.00	6.00	11.00	80.0	4
S5115.0	5.00	2.50	6.00	13.00	80.0	4
S5116.0	6.00	3.00	6.00	13.00	80.0	4
S5117.0	7.00	3.50	8.00	16.00	100.0	4
S5118.0	8.00	4.00	8.00	19.00	100.0	4
S5119.0	9.00	4.50	10.00	19.00	100.0	4
S51110.0	10.00	5.00	10.00	22.00	100.0	4
S51112.0	12.00	6.00	12.00	26.00	100.0	4
S51116.0	16.00	8.00	16.00	32.00	100.0	4

S229



Fresa de Metal Duro de 2 Filos con Punta Esférica

Fresa con longitud de corte extra corta de 2 filos con cuello rebajado, que proporciona alta rigidez y reduce vibraciones. Geometría de punta esférica diseñada para ofrecer un alto rendimiento en el contorneado de alto rendimiento de superficies complejas. El recubrimiento TiSiN aumenta la vida útil y mejora el rendimiento al fresar materiales difíciles de mecanizar.

HM	N	NOF 2
	λ 30°	γ 3°
DIN 6335HA	TiSiN	DC h9

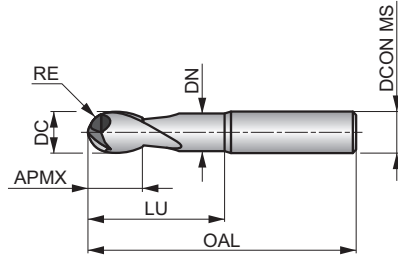

Grupo de Material de la pieza adecuado. Valores de inicio de la velocidad de corte (m/min) y código alfabético. Las tablas con avances por diente y factores de corrección en la pag. 266.

P4.3 ■ 80 F	M2.3 ■ 80 F	M3.3 ■ 82 F	M4.1 ■ 80 F	M4.2 ■ 68 F	S1.3 ■ 58 F	S2.2 ■ 47 F	S3.2 ■ 33 F	S4.2 ■ 27 F
-----------------------	-----------------------	-----------------------	-----------------------	-----------------------	-----------------------	-----------------------	-----------------------	-----------------------

DCON MS tolerancia h6; RE +0/-0.02 mm.

Product	DC (mm)	RE (mm)	DCON MS (mm)	APMX (mm)	OAL (mm)	NOF	LU (mm)	DN (mm)
S2291.5XD4	1.50	0.75	4.00	3.00	50.0	2	6.00	1.40
S2292.0XD3	2.00	1.00	3.00	4.00	50.0	2	8.00	1.90
S2292.0XD4	2.00	1.00	4.00	4.00	50.0	2	8.00	1.90
S2293.0XD3	3.00	1.50	3.00	5.00	50.0	2	14.00	2.80
S2293.0XD6	3.00	1.50	6.00	5.00	50.0	2	14.00	2.80
S2294.0XD4	4.00	2.00	4.00	8.00	50.0	2	20.00	3.70
S2294.0XD6	4.00	2.00	6.00	8.00	50.0	2	20.00	3.70
S2295.0XD5	5.00	2.50	5.00	9.00	50.0	2	20.00	4.60
S2295.0XD6	5.00	2.50	6.00	9.00	50.0	2	20.00	4.60
S2296.0	6.00	3.00	6.00	10.00	50.0	2	20.00	5.50
S2298.0	8.00	4.00	8.00	12.00	64.0	2	30.00	7.40
S22910.0	10.00	5.00	10.00	14.00	70.0	2	32.00	9.20
S22912.0	12.00	6.00	12.00	16.00	75.0	2	38.00	11.00
S22914.0	14.00	7.00	14.00	32.00	90.0	2	44.00	13.00
S22916.0	16.00	8.00	16.00	32.00	90.0	2	46.00	15.00

S231



Fresa de Metal Duro de 2 Filos con Punta Esférica, Alcance Largo

Fresa con longitud de corte extra corta y largo alcance de 2 filos con cuello reducido, que proporciona alta rigidez y reduce vibraciones. Geometría de punta esférica diseñada para el contorneado de alto rendimiento de superficies complejas. El recubrimiento TiSiN aumenta la vida útil y mejora el rendimiento al fresar materiales difíciles de mecanizar.

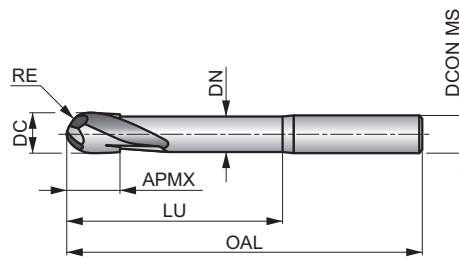

HM	N	NOF 2
	λ 30°	γ 3°
DIN 6535HA	TiSiN	DC h9



Grupo de Material de la pieza adecuado. Valores de inicio de la velocidad de corte (m/min) y código alfabético. Las tablas con avances por diente y factores de corrección en la pag. 266.

P4.3	M2.3	M3.3	M4.1	M4.2	S1.3	S2.2	S3.2	S4.2
■ 64 F	■ 64 F	■ 65 F	■ 64 F	■ 54 F	■ 46 F	■ 38 F	■ 26 F	■ 22 F

DCON MS tolerancia h6; RE +0/-0.02 mm.

Product	DC (mm)	RE (mm)	DCON MS (mm)	APMX (mm)	OAL (mm)	NOF	LU (mm)	DN (mm)
S2311.5XD4	1.50	0.75	4.00	3.00	75.0	2	10.00	1.40
S2312.0XD3	2.00	1.00	3.00	4.00	60.0	2	14.00	1.90
S2312.0XD4	2.00	1.00	4.00	4.00	75.0	2	14.00	1.90
S2313.0XD3	3.00	1.50	3.00	5.00	60.0	2	21.00	2.80
S2313.0XD6	3.00	1.50	6.00	5.00	75.0	2	21.00	2.80
S2314.0XD4	4.00	2.00	4.00	8.00	60.0	2	28.00	3.70
S2314.0XD6	4.00	2.00	6.00	8.00	75.0	2	28.00	3.70
S2315.0	5.00	2.50	5.00	9.00	60.0	2	32.00	4.60
S2316.0	6.00	3.00	6.00	10.00	75.0	2	40.00	5.50
S2318.0	8.00	4.00	8.00	10.00	75.0	2	40.00	7.40
S23110.0	10.00	5.00	10.00	12.00	75.0	2	40.00	9.20
S23112.0	12.00	6.00	12.00	16.00	100.0	2	60.00	11.00
S23116.0	16.00	8.00	16.00	32.00	125.0	2	80.00	15.00

S233

DORMER



Fresa de Metal Duro de 2 Filos con Punta Esférica, Alcance Extra Largo

Fresa con longitud de corte extra corta y alcance extra largo de 2 filos con cuello reducido, que proporciona alta rigidez y reduce vibraciones. Geometría de punta esférica diseñada para el contorneado de alto rendimiento de superficies complejas. El recubrimiento TiSiN aumenta la vida útil y mejora el rendimiento al fresar materiales difíciles de mecanizar.

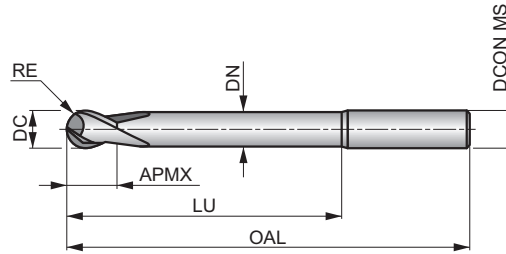

HM	N	NOF 2
	λ 30°	γ 3°
DIN 6535HA	TiSiN	DC h9



Grupo de Material de la pieza adecuado. Valores de inicio de la velocidad de corte (m/min) y código alfabético. Las tablas con avances por diente y factores de corrección en la pag. 266.

P4.3 ■ 40 F	M2.3 ■ 40 F	M3.3 ■ 41 F	M4.1 ■ 40 F	M4.2 ■ 34 F	S1.3 ■ 29 F	S2.2 ■ 24 F	S3.2 ■ 17 F	S4.2 ■ 14 F
-----------------------	-----------------------	-----------------------	-----------------------	-----------------------	-----------------------	-----------------------	-----------------------	-----------------------

DCON MS tolerancia h6; RE +0/-0.02 mm.

Product	DC (mm)	RE (mm)	DCON MS (mm)	APMX (mm)	OAL (mm)	NOF	LU (mm)	DN (mm)
S2332.0XD3	2.00	1.00	3.00	4.00	100.0	2	20.00	1.90
S2332.0XD4	2.00	1.00	4.00	4.00	100.0	2	20.00	1.90
S2333.0XD3	3.00	1.50	3.00	5.00	100.0	2	30.00	2.80
S2333.0XD6	3.00	1.50	6.00	5.00	100.0	2	30.00	2.80
S2334.0XD4	4.00	2.00	4.00	8.00	100.0	2	40.00	3.70
S2334.0XD6	4.00	2.00	6.00	8.00	100.0	2	40.00	3.70
S2335.0	5.00	2.50	5.00	9.00	100.0	2	50.00	4.60
S2336.0	6.00	3.00	6.00	10.00	100.0	2	60.00	5.50
S2338.0	8.00	4.00	8.00	12.00	100.0	2	60.00	7.40
S23310.0	10.00	5.00	10.00	14.00	125.0	2	85.00	9.20
S23312.0	12.00	6.00	12.00	16.00	125.0	2	85.00	11.00
S23314.0	14.00	7.00	14.00	32.00	150.0	2	110.00	13.00
S23316.0	16.00	8.00	16.00	32.00	150.0	2	110.00	15.00

S629



Fresa de Metal Duro de 2 Filos con Punta Esférica

Fresa con longitud de corte extra corta de 2 filos con cuello rebajado, que proporciona alta rigidez y reduce vibraciones. Geometría de punta esférica diseñada para ofrecer un alto rendimiento en el contorneado de superficies complejas en materiales no féreos.

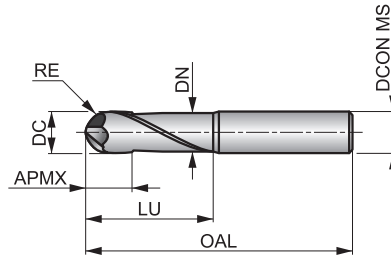

HM	W	NOF 2
	λ 30°	γ 15°
DIN 6535HA	Bright	DC h9



Grupo de Material de la pieza adecuado. Valores de inicio de la velocidad de corte (m/min) y código alfabético. Las tablas con avances por diente y factores de corrección en la pag. 266.

N1.1 ■ 709 N	N1.2 ■ 533 N	N1.3 ■ 357 N	N2.1 ■ 357 N	N2.2 ■ 320 N	N2.3 ■ 229 N	N3.1 ■ 373 N	N3.2 ■ 219 N	N3.3 ■ 112 N	N4.1 ■ 373 0	N4.2 ■ 144 0
------------------------	------------------------	------------------------	------------------------	------------------------	------------------------	------------------------	------------------------	------------------------	------------------------	------------------------

DCON MS tolerancia h6; RE +0/-0.02 mm.

Product	DC (mm)	RE (mm)	DCON MS (mm)	APMX (mm)	OAL (mm)	NOF	LU (mm)	DN (mm)
S6291.0 ¹⁾	1.00	0.50	4.00	0.80	50.0	2	10.00	0.90
S6291.5 ¹⁾	1.50	0.75	4.00	1.20	50.0	2	12.00	1.40
S6292.0 ¹⁾	2.00	1.00	4.00	1.60	60.0	2	18.00	1.90
S6293.0	3.00	1.50	6.00	5.00	57.0	2	20.00	2.80
S6294.0	4.00	2.00	6.00	6.00	57.0	2	20.00	3.70
S6295.0	5.00	2.50	6.00	7.00	57.0	2	20.00	4.60
S6296.0	6.00	3.00	6.00	8.00	57.0	2	20.00	5.50
S6298.0	8.00	4.00	8.00	10.00	64.0	2	25.00	7.40
S62910.0	10.00	5.00	10.00	12.00	75.0	2	35.00	9.20
S62912.0	12.00	6.00	12.00	14.00	75.0	2	35.00	11.00
S62916.0	16.00	8.00	16.00	18.00	90.0	2	45.00	15.00
S62920.0	20.00	10.00	20.00	22.00	100.0	2	50.00	19.00

¹⁾ ángulo de desprendimiento de 11°.

S529



Fresa de Metal Duro de 2 Filos con Punta Esférica

Fresa con longitud de corte extra corta de 2 filos con cuello rebajado, que proporciona alta rigidez y reduce vibraciones. Geometría de punta esférica diseñada para ofrecer un alto rendimiento en el contorneado de superficies complejas. El recubrimiento TiSiN aumenta la vida útil y mejora el rendimiento al fresar materiales endurecidos hasta 63 HRC.

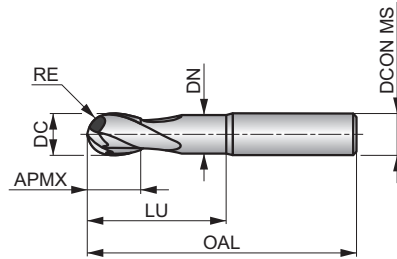

HM	N	NOF 2
	λ 30°	γ -10°
DIN 6335HA	TiSiN	DC h9



Grupo de Material de la pieza adecuado. Valores de inicio de la velocidad de corte (m/min) y código alfabético. Las tablas con avances por diente y factores de corrección en la pag. 266.

H1.1	H2.1	H2.2	H3.1	H3.2	H4.1	H4.2
■ 119 F	■ 70 E	■ 60 D	■ 78 E	■ 64 E	■ 50 D	■ 42 A

DCON MS tolerancia h6; RE +0/-0.02 mm.

Product	DC (mm)	RE (mm)	DCON MS (mm)	APMX (mm)	OAL (mm)	NOF	LU (mm)	DN (mm)
S5291.5	1.50	0.75	6.00	3.00	50.0	2	6.00	1.40
S5292.0XD4	2.00	1.00	4.00	4.00	50.0	2	8.00	1.90
S5292.0XD6	2.00	1.00	6.00	4.00	50.0	2	8.00	1.90
S5293.0XD3	3.00	1.50	3.00	5.00	50.0	2	14.00	2.80
S5293.0XD6	3.00	1.50	6.00	5.00	50.0	2	14.00	2.80
S5294.0XD4	4.00	2.00	4.00	8.00	50.0	2	20.00	3.70
S5294.0XD6	4.00	2.00	6.00	8.00	50.0	2	20.00	3.70
S5295.0XD5	5.00	2.50	5.00	9.00	50.0	2	20.00	4.60
S5295.0XD6	5.00	2.50	6.00	9.00	50.0	2	20.00	4.60
S5296.0	6.00	3.00	6.00	10.00	50.0	2	20.00	5.50
S5298.0	8.00	4.00	8.00	12.00	64.0	2	30.00	7.40
S52910.0	10.00	5.00	10.00	14.00	70.0	2	32.00	9.20
S52912.0	12.00	6.00	12.00	16.00	75.0	2	38.00	11.00
S52916.0	16.00	8.00	16.00	32.00	90.0	2	46.00	15.00

S531



Fresa de Metal Duro de 2 Filos con Punta Esférica, Alcance Largo

Fresa con longitud de corte extra corta y largo alcance de 2 filos con cuello reducido, que proporciona alta rigidez y reduce vibraciones. Geometría de punta esférica diseñada para el contorneado de superficies complejas. El recubrimiento TiSiN aumenta la vida útil y mejora el rendimiento al fresar materiales endurecidos hasta 63 HRc.

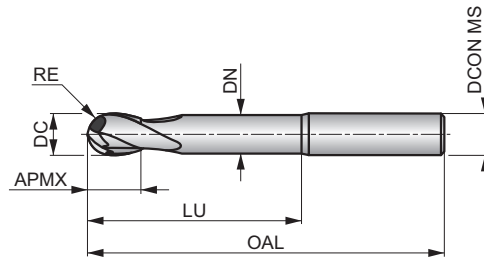

HM	N	NOF 2
	λ 30°	γ -10°
DIN 6535HA	TiSiN	DC h9



Grupo de Material de la pieza adecuado. Valores de inicio de la velocidad de corte (m/min) y código alfabético. Las tablas con avances por diente y factores de corrección en la pag. 266.

H1.1 ■ 96 F	H2.1 ■ 57 E	H2.2 ■ 49 D	H3.1 ■ 63 E	H3.2 ■ 52 E	H4.1 ■ 40 D	H4.2 ■ 34 A
-----------------------	-----------------------	-----------------------	-----------------------	-----------------------	-----------------------	-----------------------

DCON MS tolerancia h6; RE +0/-0.02 mm.

Product	DC (mm)	RE (mm)	DCON MS (mm)	APMX (mm)	OAL (mm)	NOF	LU (mm)	DN (mm)
S5311.5	1.50	0.75	6.00	3.00	75.0	2	10.00	1.40
S5312.0XD4	2.00	1.00	4.00	4.00	75.0	2	14.00	1.90
S5312.0XD6	2.00	1.00	6.00	4.00	75.0	2	14.00	1.90
S5313.0XD3	3.00	1.50	3.00	5.00	60.0	2	21.00	2.80
S5313.0XD6	3.00	1.50	6.00	5.00	75.0	2	21.00	2.80
S5314.0XD4	4.00	2.00	4.00	8.00	60.0	2	28.00	3.70
S5314.0XD6	4.00	2.00	6.00	8.00	75.0	2	28.00	3.70
S5315.0XD5	5.00	2.50	5.00	9.00	60.0	2	32.00	4.60
S5315.0XD6	5.00	2.50	6.00	9.00	75.0	2	32.00	4.60
S5316.0	6.00	3.00	6.00	10.00	75.0	2	40.00	5.50
S5318.0	8.00	4.00	8.00	12.00	75.0	2	40.00	7.40
S53110.0	10.00	5.00	10.00	14.00	75.0	2	40.00	9.20
S53112.0	12.00	6.00	12.00	16.00	100.0	2	60.00	11.00
S53116.0	16.00	8.00	16.00	32.00	125.0	2	80.00	15.00

S533



Fresa de Metal Duro de 2 Filos con Punta Esférica, Alcance Extra Largo

Fresa con longitud de corte extra corta y alcance extra largo de 2 filos con cuello reducido, que proporciona alta rigidez y reduce vibraciones. Geometría de punta esférica diseñada para el contorneado de superficies complejas. El recubrimiento TiSiN aumenta la vida útil y mejora el rendimiento al fresar materiales endurecidos hasta 63 HRc.

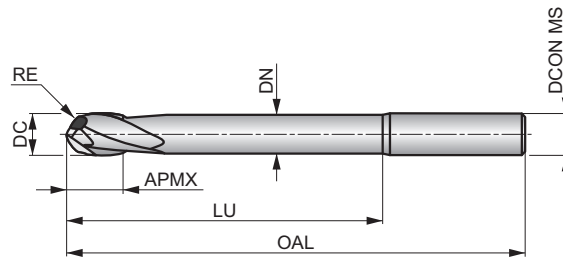

HM	N	NOF 2
	λ 30°	γ -10°
DIN 6335HA	TiSiN	DC h9



Grupo de Material de la pieza adecuado. Valores de inicio de la velocidad de corte (m/min) y código alfabético. Las tablas con avances por diente y factores de corrección en la pag. 266.

H1.1 ■ 59 F	H2.1 ■ 35 E	H2.2 ■ 30 D	H3.1 ■ 39 E	H3.2 ■ 32 E	H4.1 ■ 25 D	H4.2 ■ 21 A
-----------------------	-----------------------	-----------------------	-----------------------	-----------------------	-----------------------	-----------------------

DCON MS tolerancia h6; RE +0/-0.02 mm.

Product	DC (mm)	RE (mm)	DCON MS (mm)	APMX (mm)	OAL (mm)	NOF	LU (mm)	DN (mm)
S5332.0XD4	2.00	1.00	4.00	4.00	100.0	2	20.00	1.90
S5332.0XD6	2.00	1.00	6.00	4.00	100.0	2	20.00	1.90
S5333.0XD4	3.00	1.50	4.00	5.00	100.0	2	30.00	2.80
S5333.0XD6	3.00	1.50	6.00	5.00	100.0	2	30.00	2.80
S5334.0XD4	4.00	2.00	4.00	8.00	100.0	2	40.00	3.70
S5334.0XD6	4.00	2.00	6.00	8.00	100.0	2	40.00	3.70
S5335.0XD5	5.00	2.50	5.00	9.00	100.0	2	50.00	4.60
S5335.0XD6	5.00	2.50	6.00	9.00	100.0	2	50.00	4.60
S5336.0	6.00	3.00	6.00	10.00	100.0	2	60.00	5.50
S5338.0	8.00	4.00	8.00	12.00	100.0	2	60.00	7.40
S53310.0	10.00	5.00	10.00	14.00	125.0	2	85.00	9.20
S53312.0	12.00	6.00	12.00	16.00	125.0	2	85.00	11.00
S53314.0	14.00	7.00	14.00	32.00	150.0	2	110.00	13.00
S53316.0	16.00	8.00	16.00	32.00	150.0	2	110.00	15.00

S534



Fresa de Metal Duro de 4 Filos con Punta Esférica

Fresa con longitud de corte extra corta de 4 fillos con cuello reducido que proporciona alta rigidez y reduce vibraciones. Geometría de punta esférica diseñada para el contorneado de superficies complejas. El recubrimiento TiSiN aumenta la vida útil y mejora el rendimiento al fresar materiales endurecidos hasta 63 HRC.

HM	N	NOF 4
	λ 30°	γ -10°
DIN 6535HA	TiSiN	DC h9

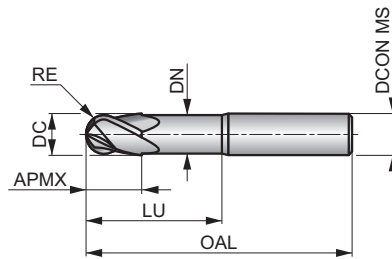

Grupo de Material de la pieza adecuado. Valores de inicio de la velocidad de corte (m/min) y código alfabético. Las tablas con avances por diente y factores de corrección en la pag. 266.

H1.1	H2.1	H2.2	H3.1	H3.2	H4.1	H4.2
■ 119 E	■ 70 D	■ 60 C	■ 78 D	■ 64 D	■ 50 C	■ 42 A

DCON MS tolerancia h6; RE +0/-0.02 mm.

Product	DC (mm)	RE (mm)	DCON MS (mm)	APMX (mm)	OAL (mm)	NOF	LU (mm)	DN (mm)
S5343.0	3.00	1.50	6.00	5.00	50.0	4	14.00	2.80
S5344.0	4.00	2.00	6.00	8.00	50.0	4	20.00	3.70
S5345.0	5.00	2.50	6.00	9.00	50.0	4	20.00	4.60
S5346.0	6.00	3.00	6.00	10.00	50.0	4	20.00	5.50
S5348.0	8.00	4.00	8.00	12.00	64.0	4	30.00	7.40
S53410.0	10.00	5.00	10.00	14.00	70.0	4	32.00	9.20
S53412.0	12.00	6.00	12.00	16.00	75.0	4	38.00	11.00
S53414.0	14.00	7.00	14.00	32.00	90.0	4	44.00	13.00
S53416.0	16.00	8.00	16.00	32.00	90.0	4	46.00	15.00

S535



Fresa de Metal Duro de 4 Filos con Punta Esférica, Alcance Largo

Fresa con longitud de corte extra corta y largo alcance de 4 fillos con cuello reducido, que proporciona alta rigidez y reduce vibraciones. Geometría de punta esférica diseñada para el contorneado de superficies complejas. El recubrimiento TiSiN aumenta la vida útil y mejora el rendimiento al fresar materiales endurecidos hasta 63 HRC.

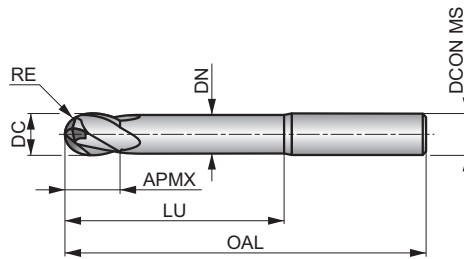

HM	N	NOF 4
	λ 30°	γ -10°
DIN 6335HA	TiSiN	DC h9



Grupo de Material de la pieza adecuado. Valores de inicio de la velocidad de corte (m/min) y código alfabético. Las tablas con avances por diente y factores de corrección en la pag. 266.

H1.1	H2.1	H2.2	H3.1	H3.2	H4.1	H4.2
■ 96 E	■ 57 D	■ 49 C	■ 63 D	■ 52 D	■ 40 C	■ 34 A

DCON MS tolerancia h6; RE +/-0.02 mm.

Product	DC (mm)	RE (mm)	DCON MS (mm)	APMX (mm)	OAL (mm)	NOF	LU (mm)	DN (mm)
S5353.0	3.00	1.50	6.00	5.00	75.0	4	21.00	2.80
S5354.0	4.00	2.00	6.00	8.00	75.0	4	28.00	3.70
S5355.0	5.00	2.50	6.00	9.00	75.0	4	32.00	4.60
S5356.0	6.00	3.00	6.00	10.00	75.0	4	40.00	5.50
S5358.0	8.00	4.00	8.00	12.00	75.0	4	40.00	7.40
S53510.0	10.00	5.00	10.00	14.00	75.0	4	40.00	9.20
S53512.0	12.00	6.00	12.00	16.00	100.0	4	60.00	11.00
S53514.0	14.00	7.00	14.00	32.00	125.0	4	80.00	13.00
S53516.0	16.00	8.00	16.00	32.00	125.0	4	80.00	15.00

S791



Fresa de Barril de Metal Duro de 3-4 Filos

Fresa con longitud de corte media de 3 o 4 filos, con un gran radio tangencial y punta esférica para incrementar el contacto con la pieza, reducir drásticamente el tiempo de mecanizado y mejorar el acabado superficial entre pasadas. El recubrimiento AlCrN aumenta la vida de la herramienta y mejora el rendimiento. Para operaciones de semi acabado y acabado.

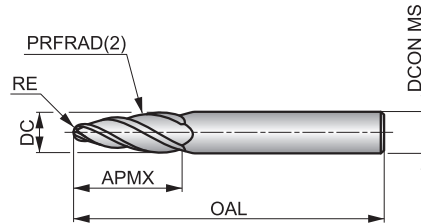

HM	N	NOF 3-4
	λ 30°	γ 8°
DIN 6535HA	AlCrN	
DORMER		



Grupo de Material de la pieza adecuado. Valores de inicio de la velocidad de corte (m/min) y código alfabético. Las tablas con avances por diente y factores de corrección en la pag. 266.

P1.1 ■ 161 F	P1.2 ■ 181 F	P1.3 ■ 186 F	P2.1 ■ 138 F	P2.2 ■ 121 F	P2.3 ■ 108 E	P3.1 ■ 112 F	P3.2 ■ 90 E	P3.3 ■ 76 E	P4.1 ■ 66 E	P4.2 ■ 57 E	P4.3 ▣ 46 E	M1.1 ■ 94 F	M1.2 ■ 79 F
M2.1 ■ 83 F	M2.2 ■ 69 E	M3.1 ▣ 77 E	M3.2 ▣ 66 E	M3.3 ▣ 59 E	M4.1 ▣ 58 E	K1.1 ■ 161 F	K1.2 ■ 119 F	K1.3 ■ 89 F	K2.1 ■ 165 F	K2.2 ■ 134 F	K2.3 ■ 107 E	K3.1 ■ 146 F	K3.2 ■ 112 F
K3.3 ■ 90 E	K4.1 ■ 136 E	K4.2 ■ 102 E	K4.3 ■ 75 E	K4.4 ■ 64 E	K4.5 ■ 54 E	K5.1 ■ 154 E	K5.2 ■ 115 E	K5.3 ■ 89 E	N1.1 ▣ 1355 I	N1.2 ▣ 1267 I	N1.3 ▣ 1179 I	N2.1 ▣ 1179 F	N2.2 ▣ 1160 F
N2.3 ▣ 115 F	N3.1 ■ 187 F	N3.2 ■ 109 F	N3.3 ▣ 56 F	N4.1 ▣ 187 F	N4.2 ▣ 72 F	S1.1 ▣ 58 E	S1.2 ▣ 56 E	S2.1 ▣ 43 E	S3.1 ▣ 33 E	S4.1 ▣ 26 E			

DCON MS tolerancia h6; RE ±0.01 mm; PRFRAD(2) ±0.01 mm.

Product	DC (mm)	RE (mm)	PRFRAD(2) (mm)	DCON MS (mm)	APMX (mm)	OAL (mm)	NOF
S7916.0	6.00	1.00	95.0	6.00	22.00	67.0	3
S7918.0	8.00	1.00	90.0	8.00	25.00	75.0	3
S79110.0	10.00	2.00	85.0	10.00	26.00	75.0	4
S79112.0	12.00	2.00	80.0	12.00	28.00	83.0	4
S79116.0	16.00	3.00	75.0	16.00	31.00	90.0	4

Forma de la rosca (THFT)													
Grupo básico estándar (BSG)													
Longitud Útil (ULDR)	2×D	2×D	2×D	2×D	1.5×D	1.5×D	2×D	2×D		1.5×D			
Código de Material (BMC)	HM	HM	HM	HM	HM	HM	HM	HM	HM	HM			
Geometría del canal (FDC)													
Ángulo de la hélice del canal (FHA)	λ 10°	λ 10°	λ 27°	λ 27°	λ 10°	λ 10°	λ 10°	λ 10°	λ 10°	λ 10°			
Mano (dirección de corte)													
Recubrimiento													
Mango													
Tipo de salida del refrigerante (CXSC)													
Código de Familia de Producto	J200	J205	J210	J215	J220	J225	J235	J245	J260	J280			
Gama de diámetros de corte PSF	M4 – M16	M8 – M16	M6 – M16	M6 – M16	M6 – M24	M12 – M18	1/4 – 3/4	1/4 – 3/4	1/8 – 2"	1/8 – 3"			
	168	169	170	171	172	173	174	175	176	177			
P	P1	■	■	■	■	■	■	■	■	■			
	P2	■	■	■	■	■	■	■	■	■			
	P3	■	■	■	■	■	■	■	■	■			
	P4	■	■	■	■	■	■	■	■	■			
M	M1	■	■	■	■	■	■	■	■	■			
	M2	■	■	■	■	■	■	■	■	■			
	M3	■	■	■	■	■	■	■	■	■			
	M4	▣	▣	■	■	▣	▣	■	■	■			
K	K1	■	■	■	■	■	■	■	■	■			
	K2	■	■	■	■	■	■	■	■	■			
	K3	■	■	■	■	■	■	■	■	■			
	K4	■	■	■	■	■	■	■	■	■			
	K5	■	■	■	■	■	■	■	■	■			
N	N1	■	■	■	■	■	■	■	■	■			
	N2	■	■	■	■	■	■	■	■	■			
	N3	■	■	■	■	■	■	■	■	■			
	N4	■	■	■	■	■	■	■	■	■			
	N5	■	■	■	■	■	■	■	■	■			
S	S1	▣	■	▣	■	▣	■	■	■	■			
	S2	▣	▣	▣	▣	▣	▣	▣	▣	▣			
	S3	▣	▣	▣	▣	▣	▣	▣	▣	▣			
	S4	▣	▣	▣	▣	▣	■	▣	▣	▣			
H	H1	▣	▣	■	■	■	■	■	■	■			
	H2												
	H3			▣	▣	▣	▣	▣	▣	▣			
	H4												

J200



Fresa de Roscar de Metal Duro, con Avellanador, Métrico

Herramienta universal de alto rendimiento para mecanizar diámetros iguales o mayores que TDZ con el mismo paso. Agujeros ciegos o pasantes a izquierda o derecha casi hasta el fondo. Con avellanador a 60° para achaflanar en un solo ciclo de mecanizado. Recubrimiento Alcrona Pro para el mejor resultado de mecanizado en una amplia gama de materiales.

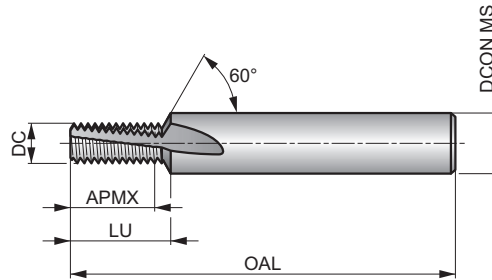

		2xD
HM		λ 10°

Grupo de Material de la pieza adecuado. Valores de inicio de la velocidad de corte (m/min) y código alfabético. Las tablas con avances por diente y factores de corrección en la pag. 266.

P1.1 ■ 172 B	P1.2 ■ 193 B	P1.3 ■ 200 B	P2.1 ■ 148 B	P2.2 ■ 130 B	P2.3 ■ 115 B	P3.1 ■ 133 B	P3.2 ■ 107 B	P3.3 ■ 90 B	P4.1 ■ 79 B	P4.2 ■ 67 B	P4.3 ▣ 55 B	M1.1 ■ 62 B	M1.2 ■ 52 B
M2.1 ■ 55 B	M2.2 ■ 45 B	M2.3 ▣ 38 B	M3.1 ■ 47 A	M3.2 ■ 40 A	M3.3 ▣ 36 A	M4.1 ■ 30 A	M4.2 ▣ 26 A	K1.1 ■ 130 B	K1.2 ■ 96 B	K1.3 ■ 72 B	K2.1 ■ 123 B	K2.2 ■ 100 B	K2.3 ■ 80 B
K3.1 ■ 109 B	K3.2 ■ 83 B	K3.3 ■ 67 B	K4.1 ■ 101 A	K4.2 ■ 76 A	K4.3 ■ 56 A	K4.4 ■ 48 A	K4.5 ▣ 40 A	K5.1 ■ 114 B	K5.2 ■ 86 B	K5.3 ■ 66 B	N1.1 ■ 400 C	N1.2 ■ 300 C	N1.3 ■ 200 C
N2.1 ■ 262 C	N2.2 ■ 235 C	N2.3 ■ 170 C	N3.1 ■ 610 C	N3.2 ■ 360 C	N3.3 ■ 180 C	N4.1 ■ 290 C	N4.2 ■ 145 C	N4.3 ■ 65 C	S1.1 ■ 40 A	S1.2 ▣ 40 A	S1.3 ▣ 30 A	S2.1 ▣ 33 A	S2.2 ▣ 25 A
S3.1 ▣ 25 A	S3.2 ▣ 21 A	S4.1 ▣ 20 A	S4.2 ▣ 16 A	H1.1 ▣ 60 A									

Rosca Interna

Product	TDZ	TP	DC	APMX	OAL	DCON MS	NOF	LU
		(mm)	(mm)	(mm)	(mm)	(mm)		(mm)
J2003.2X.7	M4	0.70	3.20	8.40	57.0	6.00	3	9.50
J2004.1X.8	M5	0.80	4.10	11.20	57.0	6.00	3	12.10
J2004.8X1.0	M6	1.00	4.80	13.00	63.0	8.00	3	14.40
J2006.5X1.25	M8	1.25	6.50	17.50	72.0	10.00	3	19.10
J2008.2X1.5	M10	1.50	8.20	21.00	83.0	12.00	3	22.80
J2009.9X1.75	M12	1.75	9.90	26.25	83.0	14.00	4	28.20
J20011.6X2.0	M14	2.00	11.60	30.00	92.0	16.00	4	32.20
J20013.6X2.0	M16	2.00	13.60	34.00	92.0	18.00	4	36.20

J205



Fresa de Roscar de Metal Duro, Refrigeración Interna y Avellanador, Métrico

Herramienta universal de alto rendimiento para mecanizar diámetros iguales o mayores que TDZ con el mismo paso. Agujeros ciegos o pasantes a izquierda o derecha casi hasta el fondo. Con avellanador a 60° para achaflanar. Recubrimiento Alcrona Pro para el mejor resultado de mecanizado y con refrigeración interna para una mejor evacuación de la viruta

		2xD
HM		λ 10°
	Alcrona Pro	DIN 6535HB

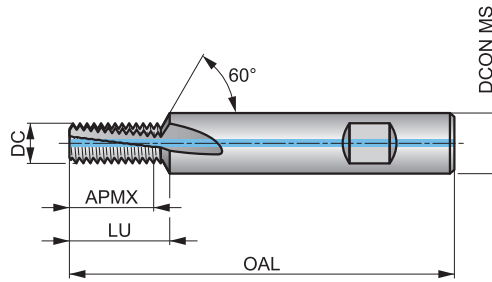

Grupo de Material de la pieza adecuado. Valores de inicio de la velocidad de corte (m/min) y código alfabético. Las tablas con avances por diente y factores de corrección en la pag. 266.

P1.1 ■ 172 B	P1.2 ■ 193 B	P1.3 ■ 200 B	P2.1 ■ 148 B	P2.2 ■ 130 B	P2.3 ■ 115 B	P3.1 ■ 133 B	P3.2 ■ 107 B	P3.3 ■ 90 B	P4.1 ■ 79 B	P4.2 ■ 67 B	P4.3 ▣ 55 B	M1.1 ■ 62 B	M1.2 ■ 52 B
M2.1 ■ 55 B	M2.2 ■ 45 B	M2.3 ■ 38 B	M3.1 ■ 47 A	M3.2 ■ 40 A	M3.3 ■ 36 A	M4.1 ■ 30 A	M4.2 ▣ 26 A	K1.1 ■ 130 B	K1.2 ■ 96 B	K1.3 ■ 72 B	K2.1 ■ 123 B	K2.2 ■ 100 B	K2.3 ■ 80 B
K3.1 ■ 109 B	K3.2 ■ 83 B	K3.3 ■ 67 B	K4.1 ■ 101 A	K4.2 ■ 76 A	K4.3 ■ 56 A	K4.4 ■ 48 A	K4.5 ▣ 40 A	K5.1 ■ 114 B	K5.2 ■ 86 B	K5.3 ■ 66 B	N1.1 ■ 400 C	N1.2 ■ 300 C	N1.3 ■ 200 C
N2.1 ■ 262 C	N2.2 ■ 235 C	N2.3 ■ 170 C	N3.1 ■ 610 C	N3.2 ■ 360 C	N3.3 ■ 180 C	N4.1 ■ 290 C	N4.2 ■ 145 C	N4.3 ■ 65 C	S1.1 ■ 40 A	S1.2 ■ 40 A	S1.3 ▣ 30 A	S2.1 ■ 33 A	S2.2 ▣ 25 A
S3.1 ■ 25 A	S3.2 ▣ 21 A	S4.1 ■ 20 A	S4.2 ▣ 16 A	H1.1 ▣ 60 A									

Rosca Interna

Product	TDZ	TP	DC	APMX	OAL	DCON MS	NOF	LU
		(mm)	(mm)	(mm)	(mm)	(mm)		(mm)
J2056.5X1.25	M8	1.25	6.50	17.50	72.0	10.00	3	19.10
J2058.2X1.50	M10	1.50	8.20	21.00	83.0	12.00	3	22.80
J2059.9X1.75	M12	1.75	9.90	26.25	83.0	14.00	4	28.20
J20511.6X2.0	M14	2.00	11.60	30.00	92.0	16.00	4	32.20
J20513.6X2.0	M16	2.00	13.60	34.00	92.0	18.00	4	36.20

J210



Fresa de Roscar de Metal Duro, con Ángulo de Hélice de 27°, Métrico

Herramienta universal de alto rendimiento para mecanizar diámetros iguales o mayores que TDZ con el mismo paso. Agujeros ciegos o pasantes a izquierda o derecha casi hasta el fondo. Recubrimiento Alcrona Pro para el mejor resultado de mecanizado en una amplia gama de materiales y hélice de 27° para una acción de corte más suave.

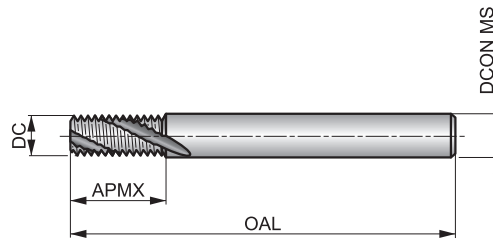

		2xD
HM		λ 27°
	Alcrona Pro	DIN 6535HA

Grupo de Material de la pieza adecuado. Valores de inicio de la velocidad de corte (m/min) y código alfabético. Las tablas con avances por diente y factores de corrección en la pag. 266.

P1.1 ■ 181 B	P1.2 ■ 203 B	P1.3 ■ 210 B	P2.1 ■ 156 B	P2.2 ■ 137 B	P2.3 ■ 121 B	P3.1 ■ 140 B	P3.2 ■ 112 B	P3.3 ■ 95 B	P4.1 ■ 83 B	P4.2 ■ 70 B	P4.3 ▣ 58 B	M1.1 ■ 65 B	M1.2 ■ 55 B
M2.1 ■ 58 B	M2.2 ■ 47 B	M2.3 ▣ 40 B	M3.1 ■ 50 A	M3.2 ■ 42 A	M3.3 ▣ 38 A	M4.1 ■ 32 A	M4.2 ▣ 27 A	K1.1 ■ 137 B	K1.2 ■ 101 B	K1.3 ■ 76 B	K2.1 ■ 129 B	K2.2 ■ 105 B	K2.3 ■ 84 B
K3.1 ■ 115 B	K3.2 ■ 87 B	K3.3 ■ 71 B	K4.1 ■ 106 A	K4.2 ■ 80 A	K4.3 ■ 59 A	K4.4 ■ 51 A	K4.5 ▣ 42 A	K5.1 ■ 120 B	K5.2 ■ 90 B	K5.3 ■ 70 B	N1.1 ■ 420 C	N1.2 ■ 315 C	N1.3 ■ 210 C
N2.1 ■ 275 C	N2.2 ■ 247 C	N2.3 ■ 179 C	N3.1 ■ 640 C	N3.2 ■ 378 C	N3.3 ■ 189 C	N4.1 ■ 305 C	N4.2 ■ 153 C	N4.3 ■ 69 C	S1.1 ■ 42 A	S1.2 ▣ 42 A	S1.3 ▣ 32 A	S2.1 ▣ 35 A	S2.2 ▣ 26 A
S3.1 ▣ 26 A	S3.2 ▣ 22 A	S4.1 ▣ 21 A	S4.2 ▣ 17 A	H1.1 ■ 63 A	H3.1 ▣ 45 A								

Rosca Interna

Product	TDZ	TP	DC	APMX	OAL	DCON MS	NOF
		(mm)	(mm)	(mm)	(mm)	(mm)	
J2104.5X1.0	M6	1.00	4.50	13.00	57.0	6.00	3
J2106.0X1.25	M8	1.25	6.00	17.50	65.0	6.00	3
J2107.5X1.5	M10	1.50	7.50	21.00	72.0	8.00	3
J2109.5X1.75	M12	1.75	9.50	26.25	80.0	10.00	3
J21010.0X2.0	M14	2.00	10.00	30.00	83.0	10.00	4
J21012.0X2.0	M16	2.00	12.00	34.00	92.0	12.00	4

J215



Fresa de Roscar de Metal Duro, con Ángulo de Hélice de 27° y Refrigeración Interna, Métrico

Herramienta universal de alto rendimiento para mecanizar diámetros iguales o mayores que TDZ con el mismo paso. Agujeros ciegos o pasantes a izquierda o derecha casi hasta el fondo. Recubrimiento Alcrona Pro para el mejor resultado de mecanizado con refrigeración interna para una mejor evacuación de la viruta y hélice de 27° para una acción de corte más suave.

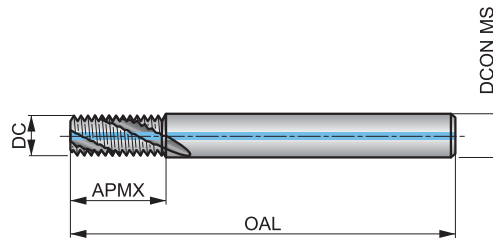

		2xD
HM		λ 27°
	Alcrona Pro	DIN 6535HA

Grupo de Material de la pieza adecuado. Valores de inicio de la velocidad de corte (m/min) y código alfabético. Las tablas con avances por diente y factores de corrección en la pag. 266.

P1.1 ■ 181 B	P1.2 ■ 203 B	P1.3 ■ 210 B	P2.1 ■ 156 B	P2.2 ■ 137 B	P2.3 ■ 121 B	P3.1 ■ 140 B	P3.2 ■ 112 B	P3.3 ■ 95 B	P4.1 ■ 83 B	P4.2 ■ 70 B	P4.3 ■ 58 B	M1.1 ■ 65 B	M1.2 ■ 55 B
M2.1 ■ 58 B	M2.2 ■ 47 B	M2.3 ■ 40 B	M3.1 ■ 50 A	M3.2 ■ 42 A	M3.3 ■ 38 A	M4.1 ■ 32 A	M4.2 □ 27 A	K1.1 ■ 137 B	K1.2 ■ 101 B	K1.3 ■ 76 B	K2.1 ■ 129 B	K2.2 ■ 105 B	K2.3 ■ 84 B
K3.1 ■ 115 B	K3.2 ■ 87 B	K3.3 ■ 71 B	K4.1 ■ 106 A	K4.2 ■ 80 A	K4.3 ■ 59 A	K4.4 ■ 51 A	K4.5 ■ 42 A	K5.1 ■ 120 B	K5.2 ■ 90 B	K5.3 ■ 70 B	N1.1 ■ 420 C	N1.2 ■ 315 C	N1.3 ■ 210 C
N2.1 ■ 275 C	N2.2 ■ 247 C	N2.3 ■ 179 C	N3.1 ■ 640 C	N3.2 ■ 378 C	N3.3 ■ 189 C	N4.1 ■ 305 C	N4.2 ■ 153 C	N4.3 ■ 69 C	S1.1 ■ 42 A	S1.2 ■ 42 A	S1.3 □ 32 A	S2.1 ■ 35 A	S2.2 □ 26 A
S3.1 ■ 26 A	S3.2 □ 22 A	S4.1 ■ 21 A	S4.2 □ 17 A	H1.1 ■ 63 A	H3.1 □ 45 A								

Rosca Interna

Product	TDZ	TP	DC	APMX	OAL	DCON MS	NOF
		(mm)	(mm)	(mm)	(mm)	(mm)	
J2154.5X1.0	M6	1.00	4.50	13.00	57.0	6.00	3
J2156.0X1.25	M8	1.25	6.00	17.50	65.0	6.00	3
J2157.5X1.5	M10	1.50	7.50	21.00	72.0	8.00	3
J2159.5X1.75	M12	1.75	9.50	26.25	80.0	10.00	3
J21510.0X2.0	M14	2.00	10.00	30.00	83.0	10.00	4
J21512.0X2.0	M16	2.00	12.00	34.00	92.0	12.00	4

J220



Fresa de Roscar de Metal Duro, Métrica Fina

Herramienta universal de alto rendimiento para mecanizar diámetros iguales o mayores que TDZ con el mismo paso. Agujeros ciegos o pasantes a izquierda o derecha casi hasta el fondo. Recubrimiento Alcrona Pro para el mejor resultado de mecanizado en una amplia gama de materiales.

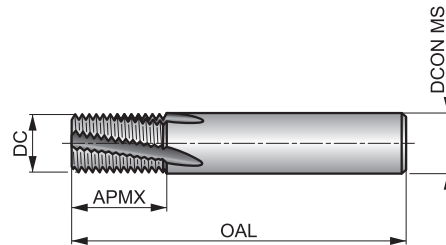

		1.5xD
HM		λ 10°

Grupo de Material de la pieza adecuado. Valores de inicio de la velocidad de corte (m/min) y código alfabético. Las tablas con avances por diente y factores de corrección en la pag. 266.

P1.1 ■ 190 E	P1.2 ■ 212 E	P1.3 ■ 242 E	P2.1 ■ 163 E	P2.2 ■ 143 E	P2.3 ■ 127 E	P3.1 ■ 146 E	P3.2 ■ 118 E	P3.3 ■ 99 E	P4.1 ■ 87 E	P4.2 ■ 74 E	P4.3 ■ 61 E	M1.1 ■ 69 E	M1.2 ■ 58 E
M2.1 ■ 61 E	M2.2 ■ 50 E	M2.3 ▣ 42 E	M3.1 ■ 52 D	M3.2 ■ 44 D	M3.3 ▣ 40 D	M4.1 ■ 33 D	M4.2 ▣ 29 D	K1.1 ■ 143 E	K1.2 ■ 106 E	K1.3 ■ 80 E	K2.1 ■ 136 E	K2.2 ■ 110 E	K2.3 ■ 88 E
K3.1 ■ 120 E	K3.2 ■ 91 E	K3.3 ■ 74 E	K4.1 ■ 111 D	K4.2 ■ 84 D	K4.3 ■ 62 D	K4.4 ■ 53 D	K4.5 ▣ 44 D	K5.1 ■ 126 E	K5.2 ■ 95 E	K5.3 ■ 73 E	N1.1 ■ 440 F	N1.2 ■ 330 F	N1.3 ■ 220 F
N2.1 ■ 288 F	N2.2 ■ 259 F	N2.3 ■ 187 F	N3.1 ■ 671 F	N3.2 ■ 396 F	N3.3 ■ 198 F	N4.1 ■ 319 F	N4.2 ■ 160 F	N4.3 ■ 72 F	S1.1 ■ 44 D	S1.2 ▣ 44 D	S1.3 ▣ 33 D	S2.1 ▣ 36 D	S2.2 ▣ 28 D
S3.1 ▣ 28 D	S3.2 ▣ 23 D	S4.1 ▣ 22 D	S4.2 ▣ 18 D	H1.1 ■ 66 D	H3.1 ▣ 48 D								

Rosca Interna

Product	TDZ	TP	DC	APMX	OAL	DCON MS	NOF
		(mm)	(mm)	(mm)	(mm)	(mm)	
J2204.8X.5	M6	0.50	4.80	10.00	57.0	6.00	3
J2206.0X.75	M8	0.75	6.00	12.00	57.0	6.00	3
J2206.0X1.0	M8	1.00	6.00	12.00	57.0	6.00	3
J2208.0X1.0	M10	1.00	8.00	16.00	63.0	8.00	4
J22010.0X1.0	M12	1.00	10.00	20.00	72.0	10.00	4
J22010.0X1.5	M12	1.50	10.00	20.00	72.0	10.00	4
J22012.0X1.0	M14	1.00	12.00	22.00	83.0	12.00	4
J22012.0X1.5	M14	1.50	12.00	22.00	83.0	12.00	4
J22014.0X1.0	M16	1.00	14.00	26.00	83.0	14.00	5
J22014.0X1.5	M16	1.50	14.00	26.00	83.0	14.00	5
J22016.0X2.0	M20	2.00	16.00	30.00	92.0	16.00	5
J22016.0X2.5	M20	2.50	16.00	42.50	105.0	16.00	5
J22019.0X3.0	M24	3.00	19.00	50.00	125.0	20.00	5
J22020.0X2.0	M24	2.00	20.00	35.00	104.0	20.00	5

J225



Fresa de Roscar de Metal Duro, Refrigeración Interna, Métrica Fina

Herramienta universal de alto rendimiento para mecanizar diámetros iguales o mayores que TDZ con el mismo paso. Agujeros ciegos o pasantes a izquierda o derecha casi hasta el fondo. Recubrimiento Alcrona Pro para el mejor resultado de mecanizado y con refrigeración interna para una mejor evacuación de la viruta.

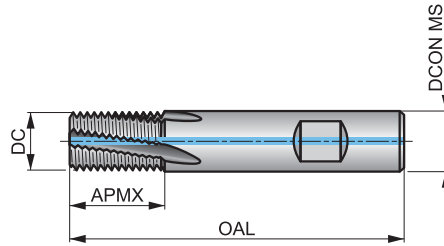

		1.5xD
HM		λ 10°
	Alcrona Pro	DIN 6535HB

Grupo de Material de la pieza adecuado. Valores de inicio de la velocidad de corte (m/min) y código alfabético. Las tablas con avances por diente y factores de corrección en la pag. 266.

P1.1 ■ 190 E	P1.2 ■ 212 E	P1.3 ■ 242 E	P2.1 ■ 163 E	P2.2 ■ 143 E	P2.3 ■ 127 E	P3.1 ■ 146 E	P3.2 ■ 118 E	P3.3 ■ 99 E	P4.1 ■ 87 E	P4.2 ■ 74 E	P4.3 ■ 61 E	M1.1 ■ 69 E	M1.2 ■ 58 E
M2.1 ■ 61 E	M2.2 ■ 50 E	M2.3 ■ 42 E	M3.1 ■ 52 D	M3.2 ■ 44 D	M3.3 ■ 40 D	M4.1 ■ 33 D	M4.2 □ 29 D	K1.1 ■ 143 E	K1.2 ■ 106 E	K1.3 ■ 80 E	K2.1 ■ 136 E	K2.2 ■ 110 E	K2.3 ■ 88 E
K3.1 ■ 120 E	K3.2 ■ 91 E	K3.3 ■ 74 E	K4.1 ■ 111 D	K4.2 ■ 84 D	K4.3 ■ 62 D	K4.4 ■ 53 D	K4.5 ■ 44 D	K5.1 ■ 126 E	K5.2 ■ 95 E	K5.3 ■ 73 E	N1.1 ■ 440 F	N1.2 ■ 330 F	N1.3 ■ 220 F
N2.1 ■ 288 F	N2.2 ■ 259 F	N2.3 ■ 187 F	N3.1 ■ 671 F	N3.2 ■ 396 F	N3.3 ■ 198 F	N4.1 ■ 319 F	N4.2 ■ 160 F	N4.3 ■ 72 F	S1.1 ■ 44 D	S1.2 ■ 44 D	S1.3 □ 33 D	S2.1 ■ 36 D	S2.2 □ 28 D
S3.1 ■ 28 D	S3.2 □ 23 D	S4.1 ■ 22 D	S4.2 □ 18 D	H1.1 ■ 66 D	H3.1 □ 48 D								

Rosca Interna

Product	TDZ	TP	DC	APMX	OAL	DCON MS	NOF
		(mm)	(mm)	(mm)	(mm)	(mm)	
J22510.0X1.5	M12	1.50	10.00	20.00	72.0	10.00	4
J22512.0X1.0	M14	1.00	12.00	22.00	83.0	12.00	4
J22514.0X1.5	M16	1.50	14.00	26.00	83.0	14.00	5
J22516.0X1.5	M18	1.50	16.00	30.00	92.0	16.00	5

J235



Fresa de Roscar de Metal Duro, Refrigeración Interna, UNC

Herramienta universal de alto rendimiento para mecanizar diámetros iguales o mayores que TDZ con el mismo paso. Agujeros ciegos o pasantes a izquierda o derecha casi hasta el fondo. Recubrimiento Alcrona Pro para el mejor resultado de mecanizado y con refrigeración interna para una mejor evacuación de la viruta.

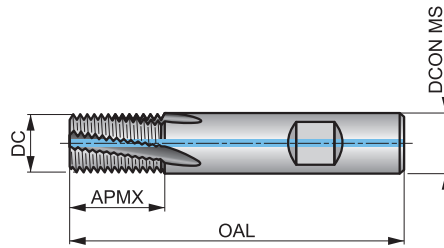

Grupo de Material de la pieza adecuado. Valores de inicio de la velocidad de corte (m/min) y código alfabético. Las tablas con avances por diente y factores de corrección en la pag. 266.

P1.1 ■ 181 H	P1.2 ■ 203 H	P1.3 ■ 210 H	P2.1 ■ 156 H	P2.2 ■ 137 H	P2.3 ■ 121 H	P3.1 ■ 140 H	P3.2 ■ 112 H	P3.3 ■ 95 H	P4.1 ■ 83 H	P4.2 ■ 70 H	P4.3 ■ 58 H	M1.1 ■ 65 H	M1.2 ■ 55 H
M2.1 ■ 58 H	M2.2 ■ 47 H	M2.3 ■ 40 H	M3.1 ■ 50 G	M3.2 ■ 42 G	M3.3 ■ 38 G	M4.1 ■ 32 G	M4.2 □ 27 G	K1.1 ■ 137 H	K1.2 ■ 101 H	K1.3 ■ 76 H	K2.1 ■ 129 H	K2.2 ■ 105 H	K2.3 ■ 84 H
K3.1 ■ 115 H	K3.2 ■ 87 H	K3.3 ■ 71 H	K4.1 ■ 106 G	K4.2 ■ 80 G	K4.3 ■ 59 G	K4.4 ■ 51 G	K4.5 ■ 42 G	K5.1 ■ 120 H	K5.2 ■ 90 H	K5.3 ■ 70 H	N1.1 ■ 420 I	N1.2 ■ 315 I	N1.3 ■ 210 I
N2.1 ■ 275 I	N2.2 ■ 247 I	N2.3 ■ 179 I	N3.1 ■ 640 I	N3.2 ■ 378 I	N3.3 ■ 189 I	N4.1 ■ 305 I	N4.2 ■ 153 I	N4.3 ■ 69 I	S1.1 ■ 42 G	S1.2 ■ 42 G	S1.3 □ 32 G	S2.1 ■ 35 G	S2.2 □ 26 G
S3.1 ■ 26 G	S3.2 □ 22 G	S4.1 ■ 21 G	S4.2 □ 17 G	H1.1 ■ 63 G	H3.1 □ 45 G								

Rosca Interna

Product	TDZ	TPI	DC	APMX	OAL	DCON MS	NOF
			(mm)	(mm)	(mm)	(mm)	
J2354.8-20	1/4	20	4.80	14.00	57.0	6.00	3
J2355.5-18	5/16	18	5.50	14.00	57.0	6.00	3
J2357.5-16	3/8	16	7.50	19.00	63.0	8.00	4
J2358.0-14	7/16	14	8.00	19.00	63.0	8.00	4
J23510.0-13	1/2	13	10.00	22.00	72.0	10.00	4
J23510.0-12	9/16	12	10.00	22.00	72.0	10.00	4
J23512.0-11	5/8	11	12.00	26.00	83.0	12.00	4
J23514.0-10	3/4	10	14.00	32.00	83.0	14.00	5

J245



Fresa de Roscar de Metal Duro, Refrigeración Interna, UNF

Herramienta universal de alto rendimiento para mecanizar diámetros iguales o mayores que TDZ con el mismo paso. Agujeros ciegos o pasantes a izquierda o derecha casi hasta el fondo. Recubrimiento Alcrona Pro para el mejor resultado de mecanizado y con refrigeración interna para una mejor evacuación de la viruta.

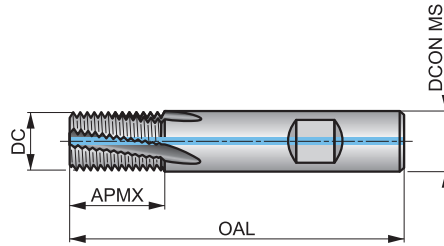

Grupo de Material de la pieza adecuado. Valores de inicio de la velocidad de corte (m/min) y código alfabético. Las tablas con avances por diente y factores de corrección en la pag. 266.

P1.1 ■ 181 K	P1.2 ■ 203 K	P1.3 ■ 210 K	P2.1 ■ 156 K	P2.2 ■ 137 K	P2.3 ■ 121 K	P3.1 ■ 140 K	P3.2 ■ 112 K	P3.3 ■ 95 K	P4.1 ■ 83 K	P4.2 ■ 70 K	P4.3 ■ 58 K	M1.1 ■ 65 K	M1.2 ■ 55 K
M2.1 ■ 58 K	M2.2 ■ 47 K	M2.3 ■ 40 K	M3.1 ■ 50 J	M3.2 ■ 42 J	M3.3 ■ 38 J	M4.1 ■ 32 J	M4.2 ▣ 27 J	K1.1 ■ 137 K	K1.2 ■ 101 K	K1.3 ■ 76 K	K2.1 ■ 129 K	K2.2 ■ 105 K	K2.3 ■ 84 K
K3.1 ■ 115 K	K3.2 ■ 87 K	K3.3 ■ 71 K	K4.1 ■ 106 J	K4.2 ■ 80 J	K4.3 ■ 59 J	K4.4 ■ 51 J	K4.5 ■ 42 J	K5.1 ■ 120 K	K5.2 ■ 90 K	K5.3 ■ 70 K	N1.1 ■ 420 L	N1.2 ■ 315 L	N1.3 ■ 210 L
N2.1 ■ 275 L	N2.2 ■ 247 L	N2.3 ■ 179 L	N3.1 ■ 640 L	N3.2 ■ 378 L	N3.3 ■ 189 L	N4.1 ■ 305 L	N4.2 ■ 153 L	N4.3 ■ 69 L	S1.1 ■ 42 J	S1.2 ■ 42 J	S1.3 ▣ 32 J	S2.1 ■ 35 J	S2.2 ▣ 26 J
S3.1 ■ 26 J	S3.2 ▣ 22 J	S4.1 ■ 21 J	S4.2 ▣ 17 J	H1.1 ■ 63 J	H3.1 ▣ 45 J								

Rosca Interna

Product	TDZ	TPI	DC	APMX	OAL	DCON MS	NOF
			(mm)	(mm)	(mm)	(mm)	
J2454.8-28	1/4	28	4.80	14.00	57.0	6.00	3
J2456.0-24	5/16, 3/8	24	6.00	14.00	57.0	6.00	3
J2458.0-20	7/16, 1/2	20	8.00	19.00	63.0	8.00	4
J24510.0-18	9/16, 5/8	18	10.00	22.00	72.0	10.00	4
J24514.0-16	3/4	16	14.00	32.00	83.0	14.00	5

J260



Fresa de Roscar de Metal Duro, NPT

Herramienta universal de alto rendimiento para mecanizar diámetros iguales o mayores que TDZ con el mismo paso. Agujeros ciegos o pasantes a izquierda o derecha casi hasta el fondo. Recubrimiento Alcrona Pro para el mejor resultado de mecanizado en una amplia gama de materiales.

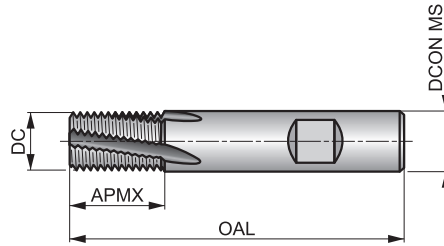

Grupo de Material de la pieza adecuado. Valores de inicio de la velocidad de corte (m/min) y código alfabético. Las tablas con avances por diente y factores de corrección en la pag. 266.

P1.1 ■ 190 R	P1.2 ■ 212 R	P1.3 ■ 242 R	P2.1 ■ 163 R	P2.2 ■ 143 R	P2.3 ■ 127 R	P3.1 ■ 146 R	P3.2 ■ 118 R	P3.3 ■ 99 R	P4.1 ■ 87 R	P4.2 ■ 74 R	P4.3 ■ 61 R	M1.1 ■ 69 R	M1.2 ■ 58 R
M2.1 ■ 61 R	M2.2 ■ 50 R	M2.3 ■ 42 R	M3.1 ■ 52 Q	M3.2 ■ 44 Q	M3.3 ■ 40 Q	M4.1 ■ 33 Q	M4.2 ▣ 29 Q	K1.1 ■ 143 R	K1.2 ■ 106 R	K1.3 ■ 80 R	K2.1 ■ 136 R	K2.2 ■ 110 R	K2.3 ■ 88 R
K3.1 ■ 120 R	K3.2 ■ 91 R	K3.3 ■ 74 R	K4.1 ■ 111 Q	K4.2 ■ 84 Q	K4.3 ■ 62 Q	K4.4 ■ 53 Q	K4.5 ■ 44 Q	K5.1 ■ 126 R	K5.2 ■ 95 R	K5.3 ■ 73 R	N1.1 ■ 440 S	N1.2 ■ 330 S	N1.3 ■ 220 S
N2.1 ■ 288 S	N2.2 ■ 259 S	N2.3 ■ 187 S	N3.1 ■ 671 S	N3.2 ■ 396 S	N3.3 ■ 198 S	N4.1 ■ 319 S	N4.2 ■ 160 S	N4.3 ■ 72 S	S1.1 ■ 44 Q	S1.2 ■ 44 Q	S1.3 ▣ 33 Q	S2.1 ■ 36 Q	S2.2 ▣ 28 Q
S3.1 ■ 28 Q	S3.2 ▣ 23 Q	S4.1 ■ 22 Q	S4.2 ▣ 18 Q	H1.1 ■ 66 Q	H3.1 ▣ 48 Q								

Rosca Interna

Product	TDZ	TPI	DC	APMX	OAL	DCON MS	NOF
			(mm)	(mm)	(mm)	(mm)	
J2607.9-27	1/8	27	7.90	11.50	58.0	8.00	3
J2609.9-18	1/4, 3/8	18	9.90	15.92	66.0	10.00	3
J26015.9-14	1/2, 3/4	14	15.90	20.46	82.0	16.00	4
J26019.9-11.5	1", 2"	11.5	19.90	27.12	92.0	20.00	5

J280



Fresa de Roscar de Metal Duro, G(BSP)

Herramienta universal de alto rendimiento para mecanizar diámetros iguales o mayores que TDZ con el mismo paso. Agujeros ciegos o pasantes a izquierda o derecha casi hasta el fondo. Recubrimiento Alcrona Pro para el mejor resultado de mecanizado en una amplia gama de materiales. Adecuada para producir roscas interiores y exteriores.

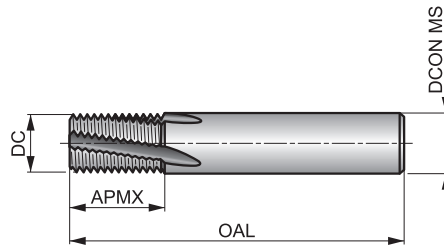

		1.5xD
HM		λ 10°
	Alcrona Pro	DIN 6535HA

Grupo de Material de la pieza adecuado. Valores de inicio de la velocidad de corte (m/min) y código alfabético. Las tablas con avances por diente y factores de corrección en la pag. 266.

P1.1 ■ 190 N	P1.2 ■ 212 N	P1.3 ■ 242 N	P2.1 ■ 163 N	P2.2 ■ 143 N	P2.3 ■ 127 N	P3.1 ■ 146 N	P3.2 ■ 118 N	P3.3 ■ 99 N	P4.1 ■ 87 N	P4.2 ■ 74 N	P4.3 ■ 61 N	M1.1 ■ 69 N	M1.2 ■ 58 N
M2.1 ■ 61 N	M2.2 ■ 50 N	M2.3 ■ 42 N	M3.1 ■ 52 M	M3.2 ■ 44 M	M3.3 ■ 40 M	M4.1 ■ 33 M	M4.2 □ 29 M	K1.1 ■ 143 N	K1.2 ■ 106 N	K1.3 ■ 80 N	K2.1 ■ 136 N	K2.2 ■ 110 N	K2.3 ■ 88 N
K3.1 ■ 120 N	K3.2 ■ 91 N	K3.3 ■ 74 N	K4.1 ■ 111 M	K4.2 ■ 84 M	K4.3 ■ 62 M	K4.4 ■ 53 M	K4.5 ■ 44 M	K5.1 ■ 126 N	K5.2 ■ 95 N	K5.3 ■ 76 N	N1.1 ■ 440 0	N1.2 ■ 330 0	N1.3 ■ 220 0
N2.1 ■ 288 0	N2.2 ■ 259 0	N2.3 ■ 187 0	N3.1 ■ 671 0	N3.2 ■ 396 0	N3.3 ■ 198 0	N4.1 ■ 319 0	N4.2 ■ 160 0	N4.3 ■ 72 0	S1.1 ■ 44 M	S1.2 ■ 44 M	S1.3 □ 33 M	S2.1 ■ 36 M	S2.2 □ 28 M
S3.1 ■ 28 M	S3.2 □ 23 M	S4.1 ■ 22 M	S4.2 □ 18 M	H1.1 ■ 66 M	H3.1 □ 48 M								

Rosca Interna y Externa

Product	TDZ	TPI	DC	APMX	OAL	DCON MS	NOF
			(mm)	(mm)	(mm)	(mm)	
J2806.0-28	1/8	28	6.00	15.00	57.0	6.00	3
J28010.0-19	1/4	19	10.00	20.00	72.0	10.00	4
J28014.0-19	3/8	19	14.00	26.00	83.0	14.00	5
J28016.0-14	1/2, 5/8	14	16.00	30.00	92.0	16.00	5
J28020.0-14	5/8, 3/4, 7/8	14	20.00	35.00	104.0	20.00	5
J28025.0-11	1", 3"	11	25.00	45.00	121.0	25.00	6



LIMAS ROTATIVAS

Código de Material (BMC)	HM	HM	HM	HM	HM	HM	HM	HM	HM	HM	HM	HM	HM
Código de Tipo de Lima Rotativa (BTC)	DC	DC	DC	DC	DC	DC	DC	DC	DC	DC	DC	DC	DC
Forma de la Lima Rotativa	A	A	B	B	C	C	D	D	E	F	F	G	G
Recubrimiento	Bright	TIAIN	Bright	TIAIN	Bright	TIAIN	Bright	TIAIN	Bright	Bright	TIAIN	Bright	TIAIN
Grupo básico estándar (BSG)	DORMER	DORMER	DORMER	DORMER	DORMER	DORMER	DORMER	DORMER	DORMER	DORMER	DORMER	DORMER	DORMER
Ángulo de aplicación													
Punta de la Lima Rotativa													
Código de Familia de Producto	P801	P801C	P803	P803C	P805	P805C	P807	P807C	P809	P811	P811C	P813	P813C
Gama de diámetros de corte PSF	3.00 – 16.00	3.00 – 12.70	3.00 – 16.00	3.00 – 12.70	3.00 – 16.00	3.00 – 12.70	3.00 – 16.00	3.00 – 12.70	3.00 – 16.00	3.00 – 16.00	3.00 – 12.70	3.00 – 16.00	3.00 – 12.70
	182	183	184	185	186	187	188	189	190	191	192	193	194
P	P1	■	■	■	■	■	■	■	■	■	■	■	■
	P2	■	■	■	■	■	■	■	■	■	■	■	■
	P3	■	■	■	■	■	■	■	■	■	■	■	■
	P4	■	■	■	■	■	■	■	■	■	■	■	■
M	M1	■	■	■	■	■	■	■	■	■	■	■	■
	M2	■	■	■	■	■	■	■	■	■	■	■	■
	M3	■	■	■	■	■	■	■	■	■	■	■	■
	M4	■	■	■	■	■	■	■	■	■	■	■	■
K	K1	■	■	■	■	■	■	■	■	■	■	■	■
	K2	■	■	■	■	■	■	■	■	■	■	■	■
	K3	■	■	■	■	■	■	■	■	■	■	■	■
	K4	■	■	■	■	■	■	■	■	■	■	■	■
	K5	■	■	■	■	■	■	■	■	■	■	■	■
N	N1												
	N2												
	N3	■	■	■	■	■	■	■	■	■	■	■	■
	N4												
	N5												
S	S1	■	■	■	■	■	■	■	■	■	■	■	■
	S2	■	■	■	■	■	■	■	■	■	■	■	■
	S3	■	■	■	■	■	■	■	■	■	■	■	■
	S4	■	■	■	■	■	■	■	■	■	■	■	■
H	H1	■	■	■	■	■	■	■	■	■	■	■	■
	H2	■	■	■	■	■	■	■	■	■	■	■	■
	H3	■	■	■	■	■	■	■	■	■	■	■	■
	H4	■	■	■	■	■	■	■	■	■	■	■	■

Primera Opción
 Opción Alternativa

ISO
13399PMK
NSH

	HM DC H Bright DORMER	HM DC H TiAlN DORMER	HM DC J Bright DORMER 60°	HM DC K Bright DORMER 90°	HM DC L Bright DORMER	HM DC L TiAlN DORMER	HM DC M Bright DORMER	HM DC N Bright DORMER							
	P815	P815C	P817	P819	P821	P821C	P823	P825							
	3.00 – 16.00	8.00 – 12.70	3.00 – 16.00	3.00 – 16.00	3.00 – 16.00	3.00 – 12.70	3.00 – 16.00	3.00 – 16.00							
	195	196	197	198	199	200	201	202							
P1	■	■	■	■	■	■	■	■							
P2	■	■	■	■	■	■	■	■							
P3	■	■	■	■	■	■	■	■							
P4	■	■	■	■	■	■	■	■							
M1	■	■	■	■	■	■	■	■							
M2	■	■	■	■	■	■	■	■							
M3	■	■	■	■	■	■	■	■							
M4	■	■	■	■	■	■	■	■							
K1	■	■	■	■	■	■	■	■							
K2	■	■	■	■	■	■	■	■							
K3	■	■	■	■	■	■	■	■							
K4	■	■	■	■	■	■	■	■							
K5	■	■	■	■	■	■	■	■							
N1															
N2															
N3	■	■	■	■	■	■	■	■							
N4															
N5															
S1	■	■	■	■	■	■	■	■							
S2	■	■	■	■	■	■	■	■							
S3	■	■	■	■	■	■	■	■							
S4	■	■	■	■	■	■	■	■							
H1	■	■	■	■	■	■	■	■							
H2	■	■	■	■	■	■	■	■							
H3	■	■	■	■	■	■	■	■							
H4	■	■	■	■	■	■	■	■							

■ Primera Opción ▣ Opción Alternativa

P801



Lima Rotativa – Cilíndrica sin corte Frontal, Forma A, Acabado Brillante

Lima rotativa tipo DC de doble corte con espacio reducido entre filos para recortar y desbarbar superficies. Metal duro integral en diámetro Ø6 mm y por encima de 6 mm cabeza de metal duro en mango de acero endurecido.

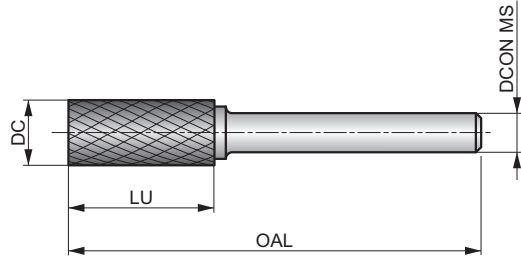

HM	A	Bright
DC		

Grupo de Material de la pieza adecuado. Velocidad operativa recomendada (RPM) en la pag. 277.

P1.1	P1.2	P1.3	P2.1	P2.2	P2.3	P3.1	P3.2	P3.3	P4.1	P4.2	P4.3	M1.1	M1.2
M2.1	M2.2	M2.3	M3.1	M3.2	M3.3	M4.1	M4.2	K1.1	K1.2	K1.3	K2.1	K2.2	K2.3
K3.1	K3.2	K3.3	K4.1	K4.2	K4.3	K4.4	K4.5	K5.1	K5.2	K5.3	N3.1	N3.2	N3.3
S1.1	S1.2	S1.3	S2.1	S2.2	S3.1	S3.2	S4.1	S4.2	H1.1	H2.1	H2.2	H3.1	H3.2
H4.1	H4.2												

DC ≤ 6.00 mm: DCON MS tolerancia h6; DC > 6.00 mm: soldada en un mango de acero con DCON MS tolerancia h7.
Los productos de esta serie también están disponibles en forma de Set. Por favor, vea P880.

Product	DC (mm)	DCON MS (mm)	LU (mm)	OAL (mm)
P8013.0X3.0	3.00	3.00	14.00	38.0
P8016.3X3.0 ¹⁾	6.30	3.00	12.70	45.0
P8016.0X6.0	6.00	6.00	18.00	50.0
P8018.0X6.0 ¹⁾	8.00	6.00	19.00	64.0
P8019.6X6.0 ¹⁾	9.60	6.00	19.00	64.0
P80112.7X6.0 ¹⁾	12.70	6.00	25.00	70.0
P80116.0X6.0 ¹⁾	16.00	6.00	25.00	70.0

¹⁾ Brazed on steel shank

P801C



Lima Rotativa – Cilíndrica sin Corte Frontal, Forma A, Recubrimiento TiAlN

Lima rotativa tipo DC de doble corte con espacio reducido entre filos para recortar y desbarbar superficies. Metal duro integral en diámetro Ø6 mm y por encima de 6 mm cabeza de metal duro en mango de acero endurecido. Recubrimiento TiAlN para alargar la vida de herramienta, reducir fricción y mejorar la evacuación de viruta.

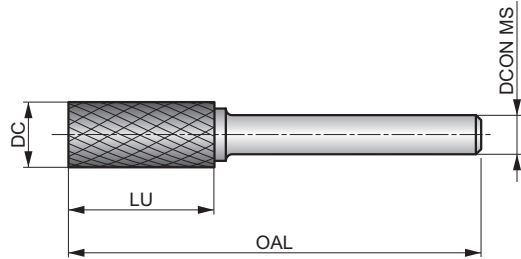

HM	A	TiAlN
DC	DORMER	



Grupo de Material de la pieza adecuado. Velocidad operativa recomendada (RPM) en la pag. 277.

P1.1	P1.2	P1.3	P2.1	P2.2	P2.3	P3.1	P3.2	P3.3	P4.1	P4.2	P4.3	M1.1	M1.2
M2.1	M2.2	M2.3	M3.1	M3.2	M3.3	M4.1	M4.2	K1.1	K1.2	K1.3	K2.1	K2.2	K2.3
K3.1	K3.2	K3.3	K4.1	K4.2	K4.3	K4.4	K4.5	K5.1	K5.2	K5.3	N3.1	N3.2	N3.3
S1.1	S1.2	S1.3	S2.1	S2.2	S3.1	S3.2	S4.1	S4.2	H1.1	H2.1	H2.2	H3.1	H3.2
H4.1	H4.2												

DC ≤ 6.00 mm: DCON MS tolerancia h6; DC > 6.00 mm: soldada en un mango de acero con DCON MS tolerancia h7.

Product	DC (mm)	DCON MS (mm)	LU (mm)	OAL (mm)
P801C3.0X3.0	3.00	3.00	14.00	38.0
P801C6.0X6.0	6.00	6.00	18.00	50.0
P801C8.0X6.0 ¹⁾	8.00	6.00	19.00	64.0
P801C9.6X6.0 ¹⁾	9.60	6.00	19.00	64.0
P801C12.7X6.0 ¹⁾	12.70	6.00	25.00	70.0

¹⁾ Brazed on steel shank

P803



Lima Rotativa – Cilíndrica con corte Frontal, Forma B, Acabado Brillante

Lima rotativa tipo DC de doble corte con espacio reducido entre filos para recortar y desbarbar superficies y esquinas a derecha. Metal duro integral en diámetro Ø6 mm y por encima de 6 mm cabeza de metal duro en mango de acero endurecido.

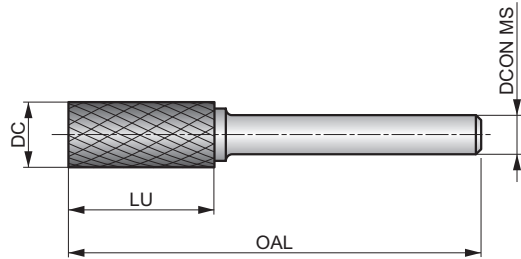

HM		
Bright	DC	



Grupo de Material de la pieza adecuado. Velocidad operativa recomendada (RPM) en la pag. 277.

P1.1	P1.2	P1.3	P2.1	P2.2	P2.3	P3.1	P3.2	P3.3	P4.1	P4.2	P4.3	M1.1	M1.2
M2.1	M2.2	M2.3	M3.1	M3.2	M3.3	M4.1	M4.2	K1.1	K1.2	K1.3	K2.1	K2.2	K2.3
K3.1	K3.2	K3.3	K4.1	K4.2	K4.3	K4.4	K4.5	K5.1	K5.2	K5.3	N3.1	N3.2	N3.3
S1.1	S1.2	S1.3	S2.1	S2.2	S3.1	S3.2	S4.1	S4.2	H1.1	H2.1	H2.2	H3.1	H3.2
H4.1	H4.2												

DC ≤ 6.00 mm: DCON MS tolerancia h6; DC > 6.00 mm: soldada en un mango de acero con DCON MS tolerancia h7.
 Los productos de esta serie también están disponibles en forma de Set. Por favor, vea P880 o P890.

Product	DC (mm)	DCON MS (mm)	LU (mm)	OAL (mm)
P8033.0X3.0	3.00	3.00	14.00	38.0
P8036.3X3.0 ¹⁾	6.30	3.00	12.70	45.0
P8036.0X6.0	6.00	6.00	18.00	50.0
P8038.0X6.0 ¹⁾	8.00	6.00	19.00	64.0
P8039.6X6.0 ¹⁾	9.60	6.00	19.00	64.0
P80312.7X6.0 ¹⁾	12.70	6.00	25.00	70.0
P80316.0X6.0 ¹⁾	16.00	6.00	25.00	70.0

¹⁾ Brazed on steel shank

P803C



Lima Rotativa – Cilíndrica con Corte Frontal, Forma B, Recubrimiento TiAlN

Lima rotativa tipo DC de doble corte con espacio reducido entre filos para recortar y desbarbar superficies y esquinas a derecha. Metal duro integral en diámetro Ø6 mm y por encima de 6 mm cabeza de metal duro en mango de acero endurecido. Recubrimiento TiAlN para alargar la vida de herramienta, reducir fricción y mejorar la evacuación de viruta.

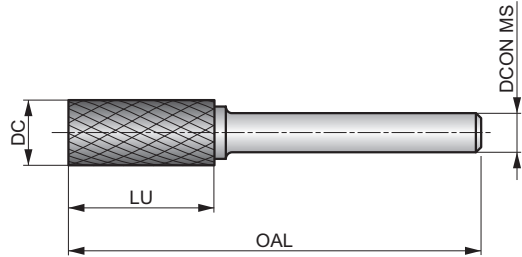

HM	B	
TiAlN	DC	DORMER



Grupo de Material de la pieza adecuado. Velocidad operativa recomendada (RPM) en la pag. 277.

P1.1	P1.2	P1.3	P2.1	P2.2	P2.3	P3.1	P3.2	P3.3	P4.1	P4.2	P4.3	M1.1	M1.2
M2.1	M2.2	M2.3	M3.1	M3.2	M3.3	M4.1	M4.2	K1.1	K1.2	K1.3	K2.1	K2.2	K2.3
K3.1	K3.2	K3.3	K4.1	K4.2	K4.3	K4.4	K4.5	K5.1	K5.2	K5.3	N3.1	N3.2	N3.3
S1.1	S1.2	S1.3	S2.1	S2.2	S3.1	S3.2	S4.1	S4.2	H1.1	H2.1	H2.2	H3.1	H3.2
H4.1	H4.2												

DC ≤ 6.00 mm: DCON MS tolerancia h6; DC > 6.00 mm: soldada en un mango de acero con DCON MS tolerancia h7.
Los productos de esta serie también están disponibles en forma de Set. Por favor, vea P880.

Product	DC (mm)	DCON MS (mm)	LU (mm)	OAL (mm)
P803C3.0X3.0	3.00	3.00	14.00	38.0
P803C6.0X6.0	6.00	6.00	18.00	50.0
P803C8.0X6.0 ¹⁾	8.00	6.00	19.00	64.0
P803C9.6X6.0 ¹⁾	9.60	6.00	19.00	64.0
P803C12.7X6.0 ¹⁾	12.70	6.00	25.00	70.0

¹⁾ Brazed on steel shank

P805



Lima Rotativa – Cilíndrica con Punta Esférica, Forma C, Acabado Brillante

Lima rotativa tipo DC de doble corte con espacio reducido entre filos para recortar y desbarbar contornos y arcos circulares. Metal duro integral en diámetro Ø6 mm y por encima de 6 mm cabeza de metal duro en mango de acero endurecido.

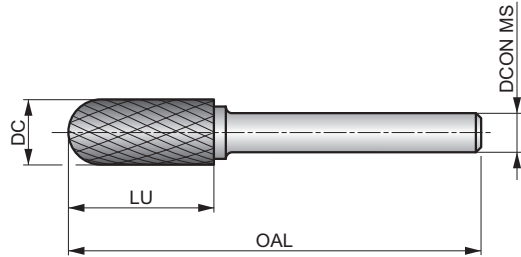

HM		Bright
DC		



Grupo de Material de la pieza adecuado. Velocidad operativa recomendada (RPM) en la pag. 277.

P1.1	P1.2	P1.3	P2.1	P2.2	P2.3	P3.1	P3.2	P3.3	P4.1	P4.2	P4.3	M1.1	M1.2
M2.1	M2.2	M2.3	M3.1	M3.2	M3.3	M4.1	M4.2	K1.1	K1.2	K1.3	K2.1	K2.2	K2.3
K3.1	K3.2	K3.3	K4.1	K4.2	K4.3	K4.4	K4.5	K5.1	K5.2	K5.3	N3.1	N3.2	N3.3
S1.1	S1.2	S1.3	S2.1	S2.2	S3.1	S3.2	S4.1	S4.2	H1.1	H2.1	H2.2	H3.1	H3.2
H4.1	H4.2												

DC ≤ 6.00 mm: DCON MS tolerancia h6; DC > 6.00 mm: soldada en un mango de acero con DCON MS tolerancia h7.
Los productos de esta serie también están disponibles en forma de Set. Por favor, vea P880 o P890.

Product	DC (mm)	DCON MS (mm)	LU (mm)	OAL (mm)
P8053.0X3.0	3.00	3.00	14.00	38.0
P8056.3X3.0 ¹⁾	6.30	3.00	12.70	45.0
P8056.0X6.0	6.00	6.00	18.00	50.0
P8058.0X6.0 ¹⁾	8.00	6.00	19.00	64.0
P8059.6X6.0 ¹⁾	9.60	6.00	19.00	64.0
P80512.7X6.0 ¹⁾	12.70	6.00	25.00	70.0
P80516.0X6.0 ¹⁾	16.00	6.00	25.00	70.0

¹⁾ Brazed on steel shank

P805C



Lima Rotativa – Cilíndrica con Punta Esférica, Forma C, Recubrimiento TiAlN

Lima rotativa tipo DC de doble corte con espacio reducido entre filos para recortar y desbarbar contornos y arcos circulares. Metal duro integral en diámetro Ø6 mm y por encima de 6 mm cabeza de metal duro en mango de acero endurecido. Recubrimiento TiAlN para alargar la vida de herramienta, reducir fricción y mejorar la evacuación de viruta.

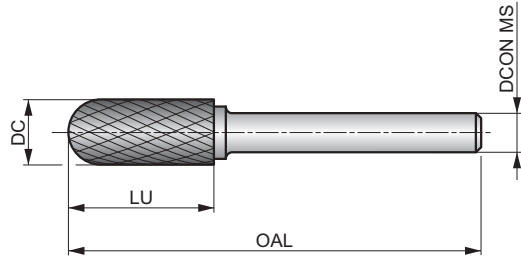

HM		
DC		



Grupo de Material de la pieza adecuado. Velocidad operativa recomendada (RPM) en la pag. 277.

P1.1	P1.2	P1.3	P2.1	P2.2	P2.3	P3.1	P3.2	P3.3	P4.1	P4.2	P4.3	M1.1	M1.2
M2.1	M2.2	M2.3	M3.1	M3.2	M3.3	M4.1	M4.2	K1.1	K1.2	K1.3	K2.1	K2.2	K2.3
K3.1	K3.2	K3.3	K4.1	K4.2	K4.3	K4.4	K4.5	K5.1	K5.2	K5.3	N3.1	N3.2	N3.3
S1.1	S1.2	S1.3	S2.1	S2.2	S3.1	S3.2	S4.1	S4.2	H1.1	H2.1	H2.2	H3.1	H3.2
H4.1	H4.2												

DC ≤ 6.00 mm: DCON MS tolerancia h6; DC > 6.00 mm: soldada en un mango de acero con DCON MS tolerancia h7.
Los productos de esta serie también están disponibles en forma de Set. Por favor, vea P880.

Product	DC (mm)	DCON MS (mm)	LU (mm)	OAL (mm)
P805C3.0X3.0	3.00	3.00	14.00	38.0
P805C6.0X6.0	6.00	6.00	18.00	50.0
P805C8.0X6.0 ¹⁾	8.00	6.00	19.00	64.0
P805C9.6X6.0 ¹⁾	9.60	6.00	19.00	64.0
P805C12.7X6.0 ¹⁾	12.70	6.00	25.00	70.0

¹⁾ Brazed on steel shank

P807



Lima Rotativa – Esférica, Forma D, Acabado Brillante

Lima rotativa tipo DC de doble corte con espacio reducido entre filos para tallado intrincado, grabado en metales y preparación para soldadura. Metal duro integral en diámetro Ø6 mm y por encima de 6 mm cabeza de metal duro en mango de acero endurecido.

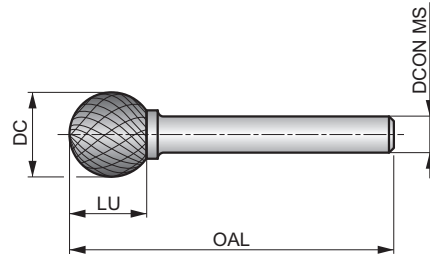

HM		Bright
DC		



Grupo de Material de la pieza adecuado. Velocidad operativa recomendada (RPM) en la pag. 277.

P1.1	P1.2	P1.3	P2.1	P2.2	P2.3	P3.1	P3.2	P3.3	P4.1	P4.2	P4.3	M1.1	M1.2
M2.1	M2.2	M2.3	M3.1	M3.2	M3.3	M4.1	M4.2	K1.1	K1.2	K1.3	K2.1	K2.2	K2.3
K3.1	K3.2	K3.3	K4.1	K4.2	K4.3	K4.4	K4.5	K5.1	K5.2	K5.3	N3.1	N3.2	N3.3
S1.1	S1.2	S1.3	S2.1	S2.2	S3.1	S3.2	S4.1	S4.2	H1.1	H2.1	H2.2	H3.1	H3.2
H4.1	H4.2												

DC ≤ 6.00 mm: DCON MS tolerancia h6; DC > 6.00 mm: soldada en un mango de acero con DCON MS tolerancia h7.
Los productos de esta serie también están disponibles en forma de Set. Por favor, vea P880.

Product	DC (mm)	DCON MS (mm)	LU (mm)	OAL (mm)
P8073.0X3.0	3.00	3.00	2.50	38.0
P8074.0X3.0	4.00	3.00	3.40	38.0
P8076.3X3.0 ¹⁾	6.30	3.00	5.00	38.0
P8076.0X6.0	6.00	6.00	4.70	50.0
P8078.0X6.0 ¹⁾	8.00	6.00	6.00	52.0
P8079.6X6.0 ¹⁾	9.60	6.00	8.00	54.0
P80712.7X6.0 ¹⁾	12.70	6.00	11.00	56.0
P80716.0X6.0 ¹⁾	16.00	6.00	14.00	59.0

¹⁾ Brazed on steel shank

P807C



Lima Rotativa – Esférica, Forma D, Recubrimiento TiAlN

Lima rotativa tipo DC de doble corte con espacio reducido entre filos para tallado intrincado, grabado en metales y preparación para soldadura. Metal duro integral en diámetro Ø6 mm y por encima de 6 mm cabeza de metal duro en mango de acero endurecido. Recubrimiento TiAlN para alargar la vida de herramienta, reducir fricción y mejorar la evacuación de viruta.

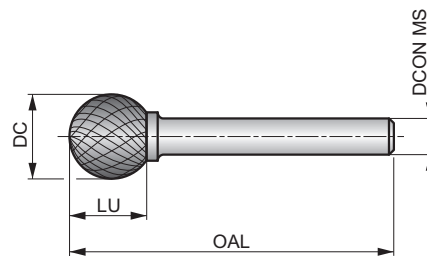

HM		
DC		



Grupo de Material de la pieza adecuado. Velocidad operativa recomendada (RPM) en la pag. 277.

P1.1	P1.2	P1.3	P2.1	P2.2	P2.3	P3.1	P3.2	P3.3	P4.1	P4.2	P4.3	M1.1	M1.2
M2.1	M2.2	M2.3	M3.1	M3.2	M3.3	M4.1	M4.2	K1.1	K1.2	K1.3	K2.1	K2.2	K2.3
K3.1	K3.2	K3.3	K4.1	K4.2	K4.3	K4.4	K4.5	K5.1	K5.2	K5.3	N3.1	N3.2	N3.3
S1.1	S1.2	S1.3	S2.1	S2.2	S3.1	S3.2	S4.1	S4.2	H1.1	H2.1	H2.2	H3.1	H3.2
H4.1	H4.2												

DC ≤ 6.00 mm: DCON MS tolerancia h6; DC > 6.00 mm: soldada en un mango de acero con DCON MS tolerancia h7. Los productos de esta serie también están disponibles en forma de Set. Por favor, vea P880.

Product	DC (mm)	DCON MS (mm)	LU (mm)	OAL (mm)
P807C3.0X3.0	3.00	3.00	2.50	38.0
P807C6.0X6.0	6.00	6.00	4.70	50.0
P807C8.0X6.0 ¹⁾	8.00	6.00	6.00	52.0
P807C9.6X6.0 ¹⁾	9.60	6.00	8.00	54.0
P807C12.7X6.0 ¹⁾	12.70	6.00	11.00	56.0

¹⁾ Brazed on steel shank

P809



Lima Rotativa – Ovalada, Forma E

Lima rotativa tipo DC de doble corte con espacio reducido entre filos para contorneado de esquinas redondas. Metal duro integral en diámetro Ø6 mm y por encima de 6 mm cabeza de metal duro en mango de acero endurecido.

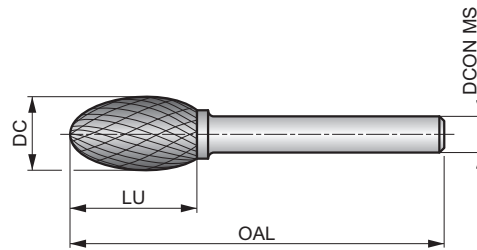

HM		Bright				
DC						

Grupo de Material de la pieza adecuado. Velocidad operativa recomendada (RPM) en la pag. 277.

P1.1	P1.2	P1.3	P2.1	P2.2	P2.3	P3.1	P3.2	P3.3	P4.1	P4.2	P4.3	M1.1	M1.2
M2.1	M2.2	M2.3	M3.1	M3.2	M3.3	M4.1	M4.2	K1.1	K1.2	K1.3	K2.1	K2.2	K2.3
K3.1	K3.2	K3.3	K4.1	K4.2	K4.3	K4.4	K4.5	K5.1	K5.2	K5.3	N3.1	N3.2	N3.3
S1.1	S1.2	S1.3	S2.1	S2.2	S3.1	S3.2	S4.1	S4.2	H1.1	H2.1	H2.2	H3.1	H3.2
H4.1	H4.2												

DC ≤ 6.00 mm: DCON MS tolerancia h6; DC > 6.00 mm: soldada en un mango de acero con DCON MS tolerancia h7.
 Los productos de esta serie también están disponibles en forma de Set. Por favor, vea P880.

Product	DC (mm)	DCON MS (mm)	LU (mm)	OAL (mm)
P8093.0X3.0	3.00	3.00	6.00	38.0
P8096.3X3.0 ¹⁾	6.30	3.00	9.50	42.0
P8096.0X6.0	6.00	6.00	10.00	50.0
P8098.0X6.0 ¹⁾	8.00	6.00	15.00	60.0
P8099.6X6.0 ¹⁾	9.60	6.00	16.00	60.0
P80912.7X6.0 ¹⁾	12.70	6.00	22.00	67.0
P80916.0X6.0 ¹⁾	16.00	6.00	25.00	70.0

¹⁾ Brazed on steel shank

P811



Lima Rotativa – Arbol con Punta Esférica, Forma F, Acabado Brillante

Lima rotativa tipo DC de doble corte con espacio reducido entre filos para contorneado en múltiples ángulos, redondeado de esquinas y corte en áreas de difícil acceso. Metal duro integral en diámetro Ø6 mm y por encima de 6 mm cabeza de metal duro en mango de acero endurecido.

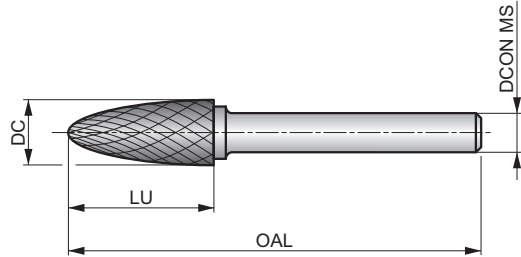

HM	F	Bright
DC		



Grupo de Material de la pieza adecuado. Velocidad operativa recomendada (RPM) en la pag. 277.

P1.1	P1.2	P1.3	P2.1	P2.2	P2.3	P3.1	P3.2	P3.3	P4.1	P4.2	P4.3	M1.1	M1.2
M2.1	M2.2	M2.3	M3.1	M3.2	M3.3	M4.1	M4.2	K1.1	K1.2	K1.3	K2.1	K2.2	K2.3
K3.1	K3.2	K3.3	K4.1	K4.2	K4.3	K4.4	K4.5	K5.1	K5.2	K5.3	N3.1	N3.2	N3.3
S1.1	S1.2	S1.3	S2.1	S2.2	S3.1	S3.2	S4.1	S4.2	H1.1	H2.1	H2.2	H3.1	H3.2
H4.1	H4.2												

DC ≤ 6.00 mm: DCON MS tolerancia h6; DC > 6.00 mm: soldada en un mango de acero con DCON MS tolerancia h7.
 Los productos de esta serie también están disponibles en forma de Set. Por favor, vea P880 o P890.

Product	DC (mm)	DCON MS (mm)	LU (mm)	OAL (mm)
P8113.0X3.0	3.00	3.00	14.00	38.0
P8116.3X3.0 ¹⁾	6.30	3.00	12.70	45.0
P8116.0X6.0	6.00	6.00	18.00	50.0
P8118.0X6.0 ¹⁾	8.00	6.00	20.00	65.0
P8119.6X6.0 ¹⁾	9.60	6.00	19.00	64.0
P81112.7X6.0 ¹⁾	12.70	6.00	25.00	70.0
P81116.0X6.0 ¹⁾	16.00	6.00	25.00	70.0

¹⁾ Brazed on steel shank

P811C



Lima Rotativa – Arbol con Punta Esférica, Forma F, Recubrimiento TiAlN

Lima rotativa tipo DC de doble corte con espacio reducido entre filos para contorneado en múltiples ángulos, redondeado de esquinas y corte en áreas de difícil acceso. Metal duro integral en diámetro Ø6 mm y por encima de 6 mm cabeza de metal duro en mango de acero endurecido. Recubrimiento TiAlN para alargar la vida de herramienta, reducir fricción y mejorar la evacuación de viruta.

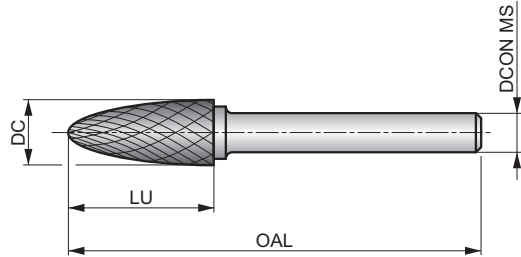

HM		
DC		



Grupo de Material de la pieza adecuado. Velocidad operativa recomendada (RPM) en la pag. 277.

P1.1	P1.2	P1.3	P2.1	P2.2	P2.3	P3.1	P3.2	P3.3	P4.1	P4.2	P4.3	M1.1	M1.2
M2.1	M2.2	M2.3	M3.1	M3.2	M3.3	M4.1	M4.2	K1.1	K1.2	K1.3	K2.1	K2.2	K2.3
K3.1	K3.2	K3.3	K4.1	K4.2	K4.3	K4.4	K4.5	K5.1	K5.2	K5.3	N3.1	N3.2	N3.3
S1.1	S1.2	S1.3	S2.1	S2.2	S3.1	S3.2	S4.1	S4.2	H1.1	H2.1	H2.2	H3.1	H3.2
H4.1	H4.2												

DC ≤ 6.00 mm: DCON MS tolerancia h6; DC > 6.00 mm: soldada en un mango de acero con DCON MS tolerancia h7. Los productos de esta serie también están disponibles en forma de Set. Por favor, vea P880.

Product	DC (mm)	DCON MS (mm)	LU (mm)	OAL (mm)
P811C3.0X3.0	3.00	3.00	14.00	38.0
P811C6.0X6.0	6.00	6.00	18.00	50.0
P811C9.6X6.0 ¹⁾	9.60	6.00	19.00	64.0
P811C12.7X6.0 ¹⁾	12.70	6.00	25.00	70.0

¹⁾ Brazed on steel shank

P813



Lima Rotativa – Arbol con punta, Forma G, Acabado Brillante

Lima rotativa tipo DC de doble corte con espacio reducido entre filos para contorneado en múltiples ángulos y corte en áreas de difícil acceso. Metal duro integral en diámetro Ø6 mm y por encima de 6 mm cabeza de metal duro en mango de acero endurecido.

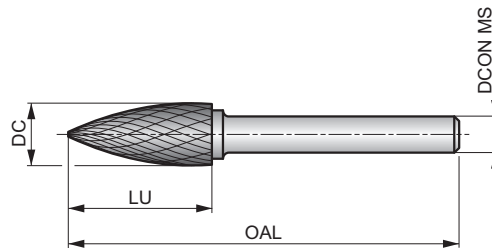

HM		Bright
DC		



Grupo de Material de la pieza adecuado. Velocidad operativa recomendada (RPM) en la pag. 277.

P1.1	P1.2	P1.3	P2.1	P2.2	P2.3	P3.1	P3.2	P3.3	P4.1	P4.2	P4.3	M1.1	M1.2
M2.1	M2.2	M2.3	M3.1	M3.2	M3.3	M4.1	M4.2	K1.1	K1.2	K1.3	K2.1	K2.2	K2.3
K3.1	K3.2	K3.3	K4.1	K4.2	K4.3	K4.4	K4.5	K5.1	K5.2	K5.3	N3.1	N3.2	N3.3
S1.1	S1.2	S1.3	S2.1	S2.2	S3.1	S3.2	S4.1	S4.2	H1.1	H2.1	H2.2	H3.1	H3.2
H4.1	H4.2												

DC ≤ 6.00 mm: DCON MS tolerancia h6; DC > 6.00 mm: soldada en un mango de acero con DCON MS tolerancia h7. Los productos de esta serie también están disponibles en forma de Set. Por favor, vea P880 o P890.

Product	DC (mm)	DCON MS (mm)	LU (mm)	OAL (mm)
P8133.0X3.0	3.00	3.00	14.00	38.0
P8136.3X3.0 ¹⁾	6.30	3.00	12.70	45.0
P8136.0X6.0	6.00	6.00	18.00	50.0
P8138.0X6.0 ¹⁾	8.00	6.00	19.00	64.0
P8139.6X6.0 ¹⁾	9.60	6.00	19.00	64.0
P81312.7X6.0 ¹⁾	12.70	6.00	25.00	70.0
P81316.0X6.0 ¹⁾	16.00	6.00	25.00	70.0

¹⁾ Brazed on steel shank

P813C



Lima Rotativa – Arbol con punta, Forma G, Recubrimiento TiAlN

Lima rotativa tipo DC de doble corte con espacio reducido entre filos para contorneado en múltiples ángulos y corte en áreas de difícil acceso. Metal duro integral en diámetro Ø6 mm y por encima de 6 mm cabeza de metal duro en mango de acero endurecido. Recubrimiento TiAlN para alargar la vida de herramienta, reducir fricción y mejorar la evacuación de viruta.

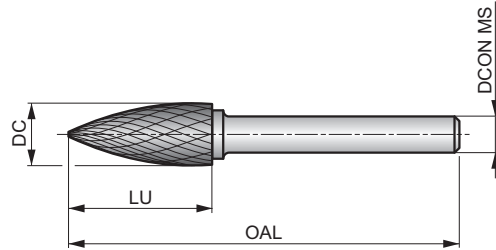

HM		
DC		



Grupo de Material de la pieza adecuado. Velocidad operativa recomendada (RPM) en la pag. 277.

P1.1	P1.2	P1.3	P2.1	P2.2	P2.3	P3.1	P3.2	P3.3	P4.1	P4.2	P4.3	M1.1	M1.2
M2.1	M2.2	M2.3	M3.1	M3.2	M3.3	M4.1	M4.2	K1.1	K1.2	K1.3	K2.1	K2.2	K2.3
K3.1	K3.2	K3.3	K4.1	K4.2	K4.3	K4.4	K4.5	K5.1	K5.2	K5.3	N3.1	N3.2	N3.3
S1.1	S1.2	S1.3	S2.1	S2.2	S3.1	S3.2	S4.1	S4.2	H1.1	H2.1	H2.2	H3.1	H3.2
H4.1	H4.2												

DC ≤ 6.00 mm: DCON MS tolerancia h6; DC > 6.00 mm: soldada en un mango de acero con DCON MS tolerancia h7. Los productos de esta serie también están disponibles en forma de Set. Por favor, vea P880.

Product	DC (mm)	DCON MS (mm)	LU (mm)	OAL (mm)
P813C3.0X3.0	3.00	3.00	14.00	38.0
P813C6.0X6.0	6.00	6.00	18.00	50.0
P813C9.6X6.0 ¹⁾	9.60	6.00	19.00	64.0
P813C12.7X6.0 ¹⁾	12.70	6.00	25.00	70.0

¹⁾ Brazed on steel shank

P815



Lima Rotativa – Llama, Forma H, Acabado Brillante

Lima rotativa tipo DC de doble corte con espacio reducido entre filos para contorneado de esquinas redondas y preparación para soldadura. Metal duro integral en diámetro Ø6 mm y por encima de 6 mm cabeza de metal duro en mango de acero endurecido.

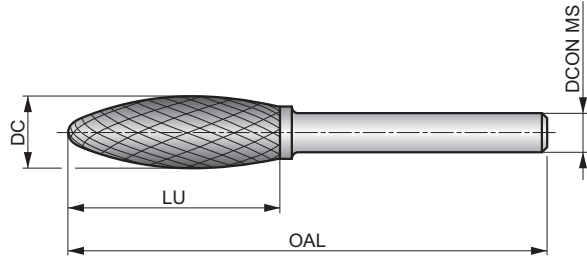

HM		Bright
DC		



Grupo de Material de la pieza adecuado. Velocidad operativa recomendada (RPM) en la pag. 277.

P1.1	P1.2	P1.3	P2.1	P2.2	P2.3	P3.1	P3.2	P3.3	P4.1	P4.2	P4.3	M1.1	M1.2
M2.1	M2.2	M2.3	M3.1	M3.2	M3.3	M4.1	M4.2	K1.1	K1.2	K1.3	K2.1	K2.2	K2.3
K3.1	K3.2	K3.3	K4.1	K4.2	K4.3	K4.4	K4.5	K5.1	K5.2	K5.3	N3.1	N3.2	N3.3
S1.1	S1.2	S1.3	S2.1	S2.2	S3.1	S3.2	S4.1	S4.2	H1.1	H2.1	H2.2	H3.1	H3.2
H4.1	H4.2												

DC ≤ 6.00 mm: DCON MS tolerancia h6; DC > 6.00 mm: soldada en un mango de acero con DCON MS tolerancia h7.
Los productos de esta serie también están disponibles en forma de Set. Por favor, vea P880.

Product	DC (mm)	DCON MS (mm)	LU (mm)	OAL (mm)
P8153.0X3.0	3.00	3.00	6.00	38.0
P8156.0X6.0	6.00	6.00	14.00	50.0
P8158.0X6.0 ¹⁾	8.00	6.00	19.00	64.0
P8159.6X6.0 ¹⁾	9.60	6.00	19.00	65.0
P81512.7X6.0 ¹⁾	12.70	6.00	32.00	77.0
P81516.0X6.0 ¹⁾	16.00	6.00	36.00	81.0

¹⁾ Brazed on steel shank

P815C



Lima Rotativa – Llama, Forma H, Recubrimiento TiAlN

Lima rotativa tipo DC de doble corte con espacio reducido entre filos para contorneado de esquinas redondas y preparación para soldadura. Cabeza de metal duro en mango de acero endurecido. Recubrimiento TiAlN para alargar la vida de herramienta, reducir fricción y mejorar la evacuación de viruta.

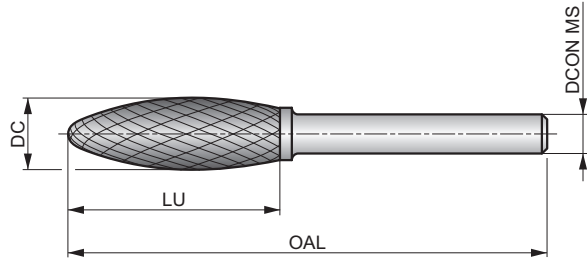

HM	H	TiAlN
DC	DORMER	



Grupo de Material de la pieza adecuado. Velocidad operativa recomendada (RPM) en la pag. 277.

P1.1	P1.2	P1.3	P2.1	P2.2	P2.3	P3.1	P3.2	P3.3	P4.1	P4.2	P4.3	M1.1	M1.2
M2.1	M2.2	M2.3	M3.1	M3.2	M3.3	M4.1	M4.2	K1.1	K1.2	K1.3	K2.1	K2.2	K2.3
K3.1	K3.2	K3.3	K4.1	K4.2	K4.3	K4.4	K4.5	K5.1	K5.2	K5.3	N3.1	N3.2	N3.3
S1.1	S1.2	S1.3	S2.1	S2.2	S3.1	S3.2	S4.1	S4.2	H1.1	H2.1	H2.2	H3.1	H3.2
H4.1	H4.2												

soldada en un mango de acero con DCON MS tolerancia h7.

Product	DC (mm)	DCON MS (mm)	LU (mm)	OAL (mm)
P815C8.0X6.0 ¹⁾	8.00	6.00	19.00	64.0
P815C12.7X6.0 ¹⁾	12.70	6.00	32.00	77.0

¹⁾ Brazed on steel shank

P817



Lima Rotativa – Cónica a 60°, Forma J

Lima rotativa tipo DC de doble corte con espacio reducido entre filos para achaflanado, cortes en V y preparación para soldadura. Metal duro integral en diámetro Ø6 mm y por encima de 6 mm cabeza de metal duro en mango de acero endurecido.

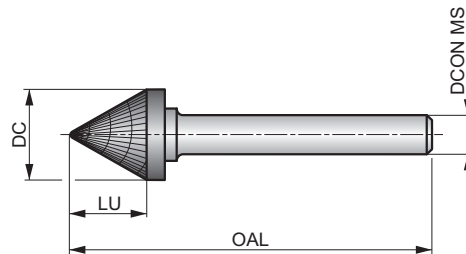

HM	J	Bright
60°	DC	DORMER



Grupo de Material de la pieza adecuado. Velocidad operativa recomendada (RPM) en la pag. 277.

P1.1	P1.2	P1.3	P2.1	P2.2	P2.3	P3.1	P3.2	P3.3	P4.1	P4.2	P4.3	M1.1	M1.2
M2.1	M2.2	M2.3	M3.1	M3.2	M3.3	M4.1	M4.2	K1.1	K1.2	K1.3	K2.1	K2.2	K2.3
K3.1	K3.2	K3.3	K4.1	K4.2	K4.3	K4.4	K4.5	K5.1	K5.2	K5.3	N3.1	N3.2	N3.3
S1.1	S1.2	S1.3	S2.1	S2.2	S3.1	S3.2	S4.1	S4.2	H1.1	H2.1	H2.2	H3.1	H3.2
H4.1	H4.2												

DC ≤ 6.00 mm: DCON MS tolerancia h6; DC > 6.00 mm: soldada en un mango de acero con DCON MS tolerancia h7.

Product	DC (mm)	DCON MS (mm)	LU (mm)	OAL (mm)
P8173.0X3.0	3.00	3.00	2.50	38.0
P8176.0X6.0	6.00	6.00	4.00	50.0
P8179.6X6.0 ¹⁾	9.60	6.00	8.00	56.0
P81712.7X6.0 ¹⁾	12.70	6.00	11.00	59.0
P81716.0X6.0 ¹⁾	16.00	6.00	14.50	63.0

¹⁾ Brazed on steel shank

P819



Lima Rotativa – Cónica a 90°, Forma K

Lima rotativa tipo DC de doble corte con espacio reducido entre filos para achaflanado, cortes en V y preparación para soldadura. Metal duro integral en diámetro Ø6 mm y por encima de 6 mm cabeza de metal duro en mango de acero endurecido.

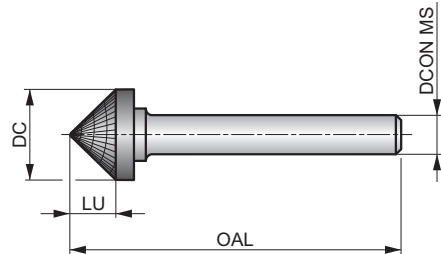

HM	K	Bright
90°	DC	DORMER



Grupo de Material de la pieza adecuado. Velocidad operativa recomendada (RPM) en la pag. 277.

P1.1	P1.2	P1.3	P2.1	P2.2	P2.3	P3.1	P3.2	P3.3	P4.1	P4.2	P4.3	M1.1	M1.2
M2.1	M2.2	M2.3	M3.1	M3.2	M3.3	M4.1	M4.2	K1.1	K1.2	K1.3	K2.1	K2.2	K2.3
K3.1	K3.2	K3.3	K4.1	K4.2	K4.3	K4.4	K4.5	K5.1	K5.2	K5.3	N3.1	N3.2	N3.3
S1.1	S1.2	S1.3	S2.1	S2.2	S3.1	S3.2	S4.1	S4.2	H1.1	H2.1	H2.2	H3.1	H3.2
H4.1	H4.2												

DC ≤ 6.00 mm: DCON MS tolerancia h6; DC > 6.00 mm: soldada en un mango de acero con DCON MS tolerancia h7.

Product	DC (mm)	DCON MS (mm)	LU (mm)	OAL (mm)
P8193.0X3.0	3.00	3.00	1.50	38.0
P8196.0X6.0	6.00	6.00	3.00	50.0
P8199.6X6.0 ¹⁾	9.60	6.00	4.70	53.0
P81912.7X6.0 ¹⁾	12.70	6.00	6.30	55.0
P81916.0X6.0 ¹⁾	16.00	6.00	8.00	57.0

¹⁾ Brazed on steel shank

P821



Lima Rotativa – Cono con Punta Esférica, Forma L, Acabado Brillante

Lima rotativa tipo DC de doble corte con espacio reducido entre filos para agrandar agujeros, redondear esquinas y acabado de superficies en ángulos estrechos u otras áreas de difícil acceso. Metal duro integral en diámetro Ø6 mm y por encima de 6 mm cabeza de metal duro en mango de acero endurecido.

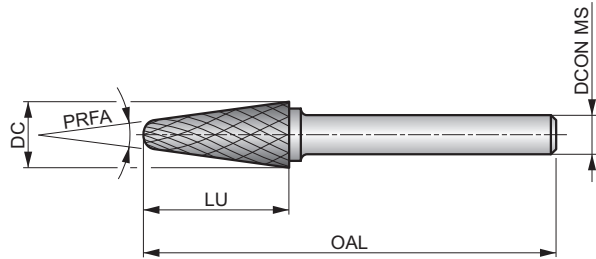

HM		Bright
DC		



Grupo de Material de la pieza adecuado. Velocidad operativa recomendada (RPM) en la pag. 277.

P1.1	P1.2	P1.3	P2.1	P2.2	P2.3	P3.1	P3.2	P3.3	P4.1	P4.2	P4.3	M1.1	M1.2
M2.1	M2.2	M2.3	M3.1	M3.2	M3.3	M4.1	M4.2	K1.1	K1.2	K1.3	K2.1	K2.2	K2.3
K3.1	K3.2	K3.3	K4.1	K4.2	K4.3	K4.4	K4.5	K5.1	K5.2	K5.3	N3.1	N3.2	N3.3
S1.1	S1.2	S1.3	S2.1	S2.2	S3.1	S3.2	S4.1	S4.2	H1.1	H2.1	H2.2	H3.1	H3.2
H4.1	H4.2												

DC ≤ 6.00 mm: DCON MS tolerancia h6; DC > 6.00 mm: soldada en un mango de acero con DCON MS tolerancia h7. Los productos de esta serie también están disponibles en forma de Set. Por favor, vea P880 o P890.

Product	DC (mm)	DCON MS (mm)	LU (mm)	OAL (mm)	PRFA (°)
P8213.0X3.0	3.00	3.00	14.00	38.0	8
P8216.0X6.0	6.00	6.00	18.00	50.0	14
P8218.0X6.0 ¹⁾	8.00	6.00	25.40	70.0	14
P8219.6X6.0 ¹⁾	9.60	6.00	30.00	76.0	14
P82112.7X6.0 ¹⁾	12.70	6.00	32.00	77.0	14
P82116.0X6.0 ¹⁾	16.00	6.00	33.00	78.0	14

¹⁾ Brazed on steel shank

P821C



Lima Rotativa – Cono con Punta Esférica, Forma L, Recubrimiento TiAlN

Lima rotativa tipo DC de doble corte con espacio reducido entre filos para agrandar agujeros, redondear esquinas y acabado de superficies en ángulos estrechos u otras áreas de difícil acceso. Metal duro integral en diámetro Ø6 mm y por encima de 6 mm cabeza de metal duro en mango de acero endurecido. Recubrimiento TiAlN para alargar la vida de herramienta.

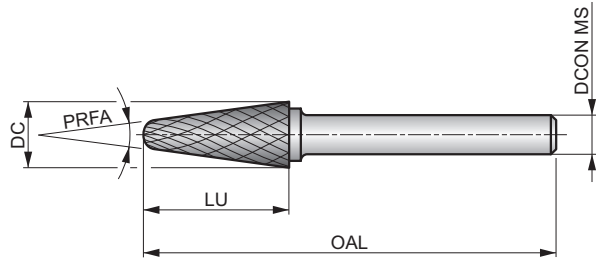

HM		
DC		



Grupo de Material de la pieza adecuado. Velocidad operativa recomendada (RPM) en la pag. 277.

P1.1	P1.2	P1.3	P2.1	P2.2	P2.3	P3.1	P3.2	P3.3	P4.1	P4.2	P4.3	M1.1	M1.2
M2.1	M2.2	M2.3	M3.1	M3.2	M3.3	M4.1	M4.2	K1.1	K1.2	K1.3	K2.1	K2.2	K2.3
K3.1	K3.2	K3.3	K4.1	K4.2	K4.3	K4.4	K4.5	K5.1	K5.2	K5.3	N3.1	N3.2	N3.3
S1.1	S1.2	S1.3	S2.1	S2.2	S3.1	S3.2	S4.1	S4.2	H1.1	H2.1	H2.2	H3.1	H3.2
H4.1	H4.2												

DC ≤ 6.00 mm: DCON MS tolerancia h6; DC > 6.00 mm: soldada en un mango de acero con DCON MS tolerancia h7.

Product	DC (mm)	DCON MS (mm)	LU (mm)	OAL (mm)	PRFA (°)
P821C3.0X3.0	3.00	3.00	14.00	38.0	8
P821C12.7X6.0 ¹⁾	12.70	6.00	32.00	77.0	14

¹⁾ Brazed on steel shank

P823



Lima Rotativa – Cono, Forma M

Lima rotativa tipo DC de doble corte con espacio reducido entre filos para agrandar agujeros y acabado de superficies en ángulos estrechos u otras áreas de difícil acceso. Metal duro integral en diámetro Ø6 mm y por encima de 6 mm cabeza de metal duro en mango de acero endurecido.

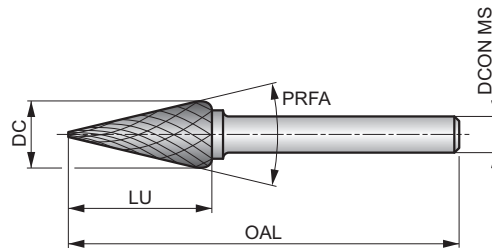

HM		Bright
DC		



Grupo de Material de la pieza adecuado. Velocidad operativa recomendada (RPM) en la pag. 277.

P1.1	P1.2	P1.3	P2.1	P2.2	P2.3	P3.1	P3.2	P3.3	P4.1	P4.2	P4.3	M1.1	M1.2
M2.1	M2.2	M2.3	M3.1	M3.2	M3.3	M4.1	M4.2	K1.1	K1.2	K1.3	K2.1	K2.2	K2.3
K3.1	K3.2	K3.3	K4.1	K4.2	K4.3	K4.4	K4.5	K5.1	K5.2	K5.3	N3.1	N3.2	N3.3
S1.1	S1.2	S1.3	S2.1	S2.2	S3.1	S3.2	S4.1	S4.2	H1.1	H2.1	H2.2	H3.1	H3.2
H4.1	H4.2												

DC ≤ 6.00 mm: DCON MS tolerancia h6; DC > 6.00 mm: soldada en un mango de acero con DCON MS tolerancia h7.
 Los productos de esta serie también están disponibles en forma de Set. Por favor, vea P880.

Product	DC (mm)	DCON MS (mm)	LU (mm)	OAL (mm)	PRFA (°)
P8233.0X3.0	3.00	3.00	11.00	38.0	14
P8236.3X3.0 ¹⁾	6.30	3.00	12.70	49.0	22
P8236.0X6.0	6.00	6.00	20.00	50.0	14
P8239.6X6.0 ¹⁾	9.60	6.00	16.00	64.0	28
P82312.7X6.0 ¹⁾	12.70	6.00	22.00	71.0	28
P82316.0X6.0 ¹⁾	16.00	6.00	25.00	71.0	31

¹⁾ Brazed on steel shank

P825



Lima Rotativa – Cono Invertido, Forma N

Lima rotativa tipo DC de doble corte con espacio reducido entre filos para cortes en V invertidos y achaflanado trasero. Metal duro integral en diámetro Ø6 mm y por encima de 6 mm cabeza de metal duro en mango de acero endurecido.

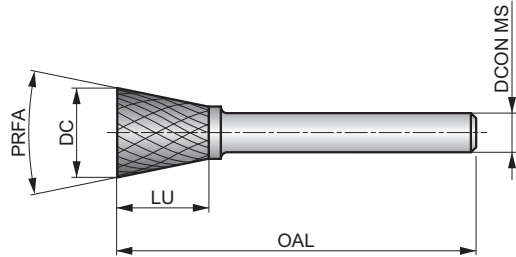

HM		Bright
DC		

Grupo de Material de la pieza adecuado. Velocidad operativa recomendada (RPM) en la pag. 277.

P1.1	P1.2	P1.3	P2.1	P2.2	P2.3	P3.1	P3.2	P3.3	P4.1	P4.2	P4.3	M1.1	M1.2
M2.1	M2.2	M2.3	M3.1	M3.2	M3.3	M4.1	M4.2	K1.1	K1.2	K1.3	K2.1	K2.2	K2.3
K3.1	K3.2	K3.3	K4.1	K4.2	K4.3	K4.4	K4.5	K5.1	K5.2	K5.3	N3.1	N3.2	N3.3
S1.1	S1.2	S1.3	S2.1	S2.2	S3.1	S3.2	S4.1	S4.2	H1.1	H2.1	H2.2	H3.1	H3.2
H4.1	H4.2												

DC ≤ 6.00 mm: DCON MS tolerancia h6; DC > 6.00 mm: soldada en un mango de acero con DCON MS tolerancia h7.

Product	DC (mm)	DCON MS (mm)	LU (mm)	OAL (mm)	PRFA (°)
P8253.0X3.0	3.00	3.00	4.00	38.0	10
P8256.3X3.0 ¹⁾	6.30	3.00	6.00	39.0	12
P8256.0X6.0	6.00	6.00	8.00	50.0	10
P8259.6X6.0 ¹⁾	9.60	6.00	9.50	55.0	16
P82512.7X6.0 ¹⁾	12.70	6.00	12.70	58.0	28
P82516.0X6.0 ¹⁾	16.00	6.00	19.00	64.0	18

¹⁾ Brazed on steel shank

Código de Material (BMC)		HM	HM	HM	HM	HM	HM	HM	HM										
Código de Tipo de Lima Rotativa (BTC)		ST	ST	ST	ST	ST	ST	ST	ST	ST									
Forma de la Lima Rotativa																			
Recubrimiento		Bright	Bright	Bright	Bright	Bright	Bright	Bright	Bright	Bright									
Grupo básico estándar (BSG)																			
Punta de la Lima Rotativa																			
Código de Familia de Producto		P701	P703	P705	P707	P709	P711	P713	P715	P721									
Gama de diámetros de corte PSF		6.00 – 12.70	6.00 – 12.70	6.00 – 12.70	6.00 – 12.70	12.70	6.00 – 12.70	6.00 – 12.70	8.00 – 12.70	9.60 – 12.70									
		204	205	206	207	208	209	210	211	212									
P	P1	■	■	■	■	■	■	■	■	■									
	P2	■	■	■	■	■	■	■	■	■									
	P3	■	■	■	■	■	■	■	■	■									
	P4	■	■	■	■	■	■	■	■	■									
M	M1																		
	M2																		
	M3																		
	M4																		
K	K1																		
	K2																		
	K3																		
	K4																		
	K5																		
N	N1																		
	N2																		
	N3																		
	N4																		
	N5																		
S	S1																		
	S2																		
	S3																		
	S4																		
H	H1																		
	H2																		
	H3																		
	H4																		

P701



Lima Rotativa – Cilíndrica sin Corte Frontal, Forma A

Lima rotativa tipo ST de un solo corte con rompevirutas y espacio medio entre filos para recortar y desbarbar superficies. Metal duro integral en diámetro Ø6 mm y por encima de 6 mm cabeza de metal duro en mango de acero endurecido. Primera elección para aceros.

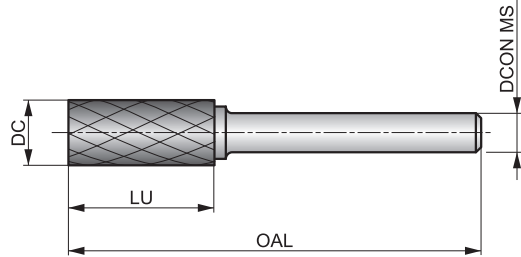

HM		Bright
ST		



Grupo de Material de la pieza adecuado. Velocidad operativa recomendada (RPM) en la pag. 277.

- | | | | | | | | | | | | |
|------|------|------|------|------|------|------|------|------|------|------|------|
| P1.1 | P1.2 | P1.3 | P2.1 | P2.2 | P2.3 | P3.1 | P3.2 | P3.3 | P4.1 | P4.2 | P4.3 |
| ■ | ■ | ■ | ■ | ■ | ■ | ■ | ■ | ■ | ■ | ■ | ■ |

DC=6.00 mm: DCON MS tolerancia h6; DC > 6.00 mm: Soldada en un mango de acero con DCON MS tolerancia h7.

Product	DC (mm)	DCON MS (mm)	LU (mm)	OAL (mm)
P7016.0X6.0	6.00	6.00	18.00	50.0
P7018.0X6.0 ¹⁾	8.00	6.00	19.00	64.0
P7019.6X6.0 ¹⁾	9.60	6.00	19.00	64.0
P70112.7X6.0 ¹⁾	12.70	6.00	25.00	70.0

¹⁾ Brazed on steel shank

P703



Lima Rotativa – Cilíndrica con Corte Frontal, Forma B

Lima rotativa tipo ST de un solo corte con rompevirutas y espacio medio entre filos para recortar y desbarbar superficies y esquinas a derecha. Metal duro integral en diámetro Ø6 mm y por encima de 6 mm cabeza de metal duro en mango de acero endurecido. Primera elección para aceros.

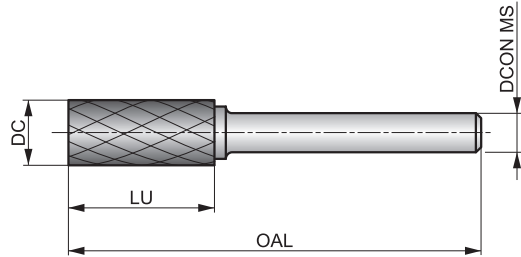

HM	B	
Bright	ST	



Grupo de Material de la pieza adecuado. Velocidad operativa recomendada (RPM) en la pag. 277.

- P1.1
- P1.2
- P1.3
- P2.1
- P2.2
- P2.3
- P3.1
- P3.2
- P3.3
- P4.1
- P4.2
- P4.3

DC=6.00 mm: DCON MS tolerancia h6; DC > 6.00 mm: Soldada en un mango de acero con DCON MS tolerancia h7. Los productos de esta serie también están disponibles en forma de Set. Por favor, vea P880.

Product	DC (mm)	DCON MS (mm)	LU (mm)	OAL (mm)
P7036.0X6.0	6.00	6.00	18.00	50.0
P7038.0X6.0 ¹⁾	8.00	6.00	19.00	64.0
P7039.6X6.0 ¹⁾	9.60	6.00	19.00	64.0
P70312.7X6.0 ¹⁾	12.70	6.00	25.00	70.0

¹⁾ Brazed on steel shank

P705



Lima Rotativa – Cilíndrica con Punta Esférica, Forma C

Lima rotativa tipo ST de un solo corte con rompevirutas y espacio medio entre filos para recortar y desbarbar contornos y arcos circulares. Metal duro integral en diámetro Ø6 mm y por encima de 6 mm cabeza de metal duro en mango de acero endurecido. Primera elección para aceros.

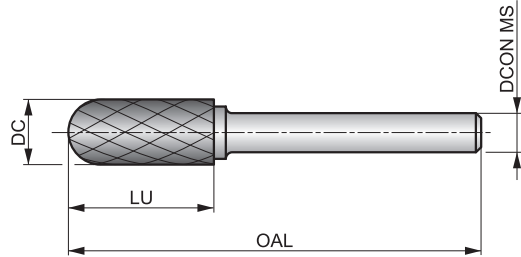

HM	
ST	



Grupo de Material de la pieza adecuado. Velocidad operativa recomendada (RPM) en la pag. 277.

- P1.1
- P1.2
- P1.3
- P2.1
- P2.2
- P2.3
- P3.1
- P3.2
- P3.3
- P4.1
- P4.2
- P4.3

DC=6.00 mm: DCON MS tolerancia h6; DC > 6.00 mm: Soldada en un mango de acero con DCON MS tolerancia h7.
Los productos de esta serie también están disponibles en forma de Set. Por favor, vea P880.

Product	DC (mm)	DCON MS (mm)	LU (mm)	OAL (mm)
P7056.0X6.0	6.00	6.00	18.00	50.0
P7058.0X6.0 ¹⁾	8.00	6.00	19.00	64.0
P7059.6X6.0 ¹⁾	9.60	6.00	19.00	64.0
P70512.7X6.0 ¹⁾	12.70	6.00	25.00	70.0

¹⁾ Brazed on steel shank

P707



Lima Rotativa – Esférica, Forma D

Lima rotativa tipo ST de un solo corte con rompevirutas y espacio medio entre filos para tallado intrincado, grabado en metales y preparación para soldadura. Metal duro integral en diámetro Ø6 mm y por encima de 6 mm cabeza de metal duro en mango de acero endurecido. Primera elección para aceros.

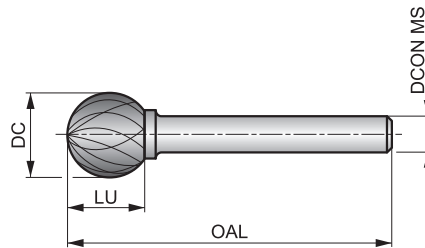

HM		Bright
ST		



Grupo de Material de la pieza adecuado. Velocidad operativa recomendada (RPM) en la pag. 277.

- P1.1
- P1.2
- P1.3
- P2.1
- P2.2
- P2.3
- P3.1
- P3.2
- P3.3
- P4.1
- P4.2
- P4.3

DC=6.00 mm: DCON MS tolerancia h6; DC > 6.00 mm: Soldada en un mango de acero con DCON MS tolerancia h7. Los productos de esta serie también están disponibles en forma de Set. Por favor, vea P880.

Product	DC (mm)	DCON MS (mm)	LU (mm)	OAL (mm)
P7076.0X6.0	6.00	6.00	4.70	50.0
P7078.0X6.0 ¹⁾	8.00	6.00	6.00	52.0
P7079.6X6.0 ¹⁾	9.60	6.00	8.00	54.0
P70712.7X6.0 ¹⁾	12.70	6.00	11.00	56.0

¹⁾ Brazed on steel shank

P709



Lima Rotativa – Ovalada, Forma E

Lima rotativa tipo ST de un solo corte con rompevirutas y espacio medio entre filos para contorneado de esquinas redondas. Cabeza de metal duro en mango de acero endurecido. Primera elección para aceros.

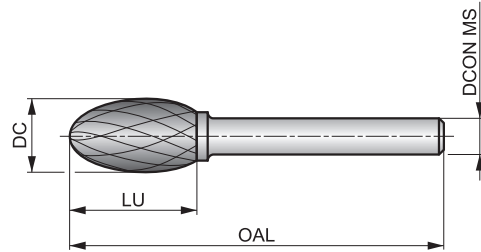

HM	E	Bright
ST		



Grupo de Material de la pieza adecuado. Velocidad operativa recomendada (RPM) en la pag. 277.

P1.1	P1.2	P1.3	P2.1	P2.2	P2.3	P3.1	P3.2	P3.3	P4.1	P4.2	P4.3
■	■	■	■	■	■	■	■	■	■	■	■

soldada en un mango de acero con DCON MS tolerancia h7.

Product	DC (mm)	DCON MS (mm)	LU (mm)	OAL (mm)
P70912.7X6.0¹⁾	12.70	6.00	22.00	67.0

¹⁾ Brazed on steel shank

P711



Lima Rotativa – Arbol con Punta Esférica, Forma F

Lima rotativa tipo ST de un solo corte con rompevirutas y espacio medio entre filos para contorneado en múltiples ángulos, redondeado de esquinas y corte en áreas de difícil acceso. Metal duro integral en diámetro Ø6 mm y por encima de 6 mm cabeza de metal duro en mango de acero endurecido. Primera elección para aceros.

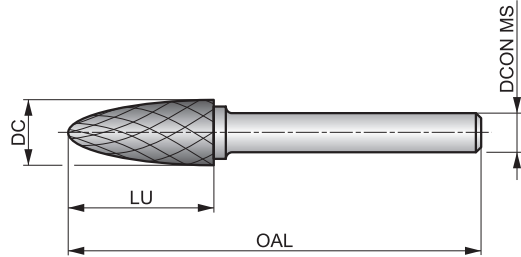

HM	F	Bright
ST		



Grupo de Material de la pieza adecuado. Velocidad operativa recomendada (RPM) en la pag. 277.

- P1.1
- P1.2
- P1.3
- P2.1
- P2.2
- P2.3
- P3.1
- P3.2
- P3.3
- P4.1
- P4.2
- P4.3

DC=6.00 mm: DCON MS tolerancia h6; DC > 6.00 mm: Soldada en un mango de acero con DCON MS tolerancia h7.
Los productos de esta serie también están disponibles en forma de Set. Por favor, vea P880.

Product	DC (mm)	DCON MS (mm)	LU (mm)	OAL (mm)
P7116.0X6.0	6.00	6.00	18.00	50.0
P7118.0X6.0 ¹⁾	8.00	6.00	20.00	65.0
P7119.6X6.0 ¹⁾	9.60	6.00	19.00	64.0
P71112.7X6.0 ¹⁾	12.70	6.00	25.00	70.0

¹⁾ Brazed on steel shank

P713



Lima Rotativa – Arbol con Punta, Forma G

Lima rotativa tipo ST de un solo corte con rompevirutas y espacio medio entre filos para contorneado en múltiples ángulos y corte en áreas de difícil acceso. Metal duro integral en diámetro Ø6 mm y por encima de 6 mm cabeza de metal duro en mango de acero endurecido. Primera elección para aceros.

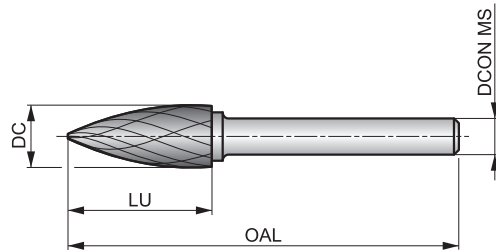

HM		Bright
ST		



Grupo de Material de la pieza adecuado. Velocidad operativa recomendada (RPM) en la pag. 277.

- P1.1
- P1.2
- P1.3
- P2.1
- P2.2
- P2.3
- P3.1
- P3.2
- P3.3
- P4.1
- P4.2
- P4.3

DC=6.00 mm: DCON MS tolerancia h6; DC > 6.00 mm: Soldada en un mango de acero con DCON MS tolerancia h7.

Product	DC (mm)	DCON MS (mm)	LU (mm)	OAL (mm)
P7136.0X6.0	6.00	6.00	18.00	50.0
P7138.0X6.0 ¹⁾	8.00	6.00	19.00	64.0
P7139.6X6.0 ¹⁾	9.60	6.00	19.00	64.0
P71312.7X6.0 ¹⁾	12.70	6.00	25.00	70.0

¹⁾ Brazed on steel shank

P715



Lima Rotativa – Llama, Forma H

Lima rotativa tipo ST de un solo corte con rompevirutas y espacio medio entre filos para contorneado de esquinas redondas y preparación para soldadura. Cabeza de metal duro en mango de acero endurecido. Primera elección para aceros.

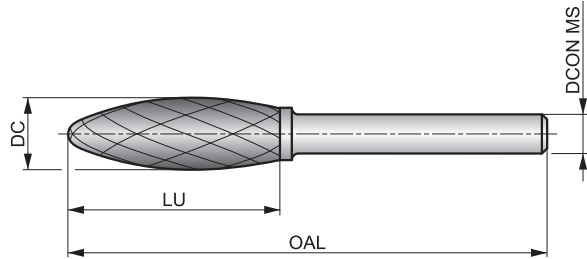

HM	H	Bright
ST	DORMER	



Grupo de Material de la pieza adecuado. Velocidad operativa recomendada (RPM) en la pag. 277.

- P1.1
- P1.2
- P1.3
- P2.1
- P2.2
- P2.3
- P3.1
- P3.2
- P3.3
- P4.1
- P4.2
- P4.3

soldada en un mango de acero con DCON MS tolerancia h7.

Product	DC (mm)	DCON MS (mm)	LU (mm)	OAL (mm)
P7158.0X6.0 ¹⁾	8.00	6.00	19.00	64.0
P71512.7X6.0 ¹⁾	12.70	6.00	32.00	77.0

¹⁾ Brazed on steel shank



P721



Lima Rotativa – Cono con Punta Esférica, Forma L

Lima rotativa tipo ST de un solo corte con rompevirutas y espacio medio entre filos para agrandar agujeros, redondear esquinas y acabado de superficies en ángulos cerrados y estrechos u otras áreas de difícil alcance. Cabeza de metal duro en mango de acero endurecido. Primera elección para aceros.

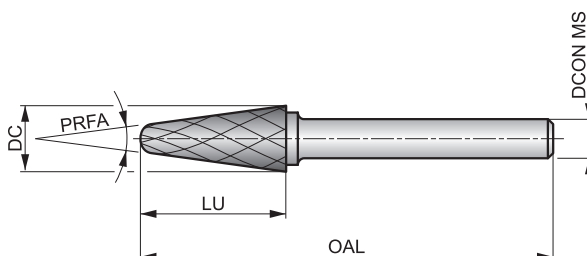

HM		Bright
ST		



Grupo de Material de la pieza adecuado. Velocidad operativa recomendada (RPM) en la pag. 277.

P1.1	P1.2	P1.3	P2.1	P2.2	P2.3	P3.1	P3.2	P3.3	P4.1	P4.2	P4.3
■	■	■	■	■	■	■	■	■	■	■	■

soldada en un mango de acero con DCON MS tolerancia h7.

Los productos de esta serie también están disponibles en forma de Set. Por favor, vea P880.

Product	DC (mm)	DCON MS (mm)	LU (mm)	OAL (mm)	PRFA (°)
P72110.0X6.0 ¹⁾	10.00	6.00	20.00	65.0	14
P7219.6X6.0 ¹⁾	9.60	6.00	30.00	76.0	14
P72112.7X6.0 ¹⁾	12.70	6.00	32.00	77.0	14

¹⁾ Brazed on steel shank

ISO
13399PMK
NSH

Código de Material (BMC)

HM

HM

HM

HM

HM

HM

HM

HM

Código de Tipo de Lima Rotativa (BTC)

VA

VA

VA

VA

VA

VA

VA

VA

Forma de la Lima Rotativa



Recubrimiento



Grupo básico estándar (BSG)



Código de Familia de Producto

P601

P605

P607

P609

P611

P613

P615

P621

Gama de diámetros de corte
PSF

3.00 - 12.70

3.00 - 12.70

3.00 - 12.70

8.00 - 12.70

3.00 - 12.70

6.00 - 12.70

8.00 - 12.70

8.00 - 12.70



214



215



216



217



218



219



220



221

P

P1

P2

P3

P4

M

M1

M2

M3

M4

K

K1

K2

K3

K4

K5

N

N1

N2

N3

N4

N5

S

S1

S2

S3

S4

H

H1

H2

H3

H4



■ Primera Opción

▣ Opción Alternativa

P601



Lima Rotativa – Cilíndrica sin Corte Frontal, Forma A

Lima rotativa tipo VA de un solo corte y espacio medio entre filos para recortar y desbarbar superficies. Metal duro integral en diámetro Ø6 mm y por encima de 6 mm cabeza de metal duro en mango de acero endurecido. Primera elección para aceros inoxidables.

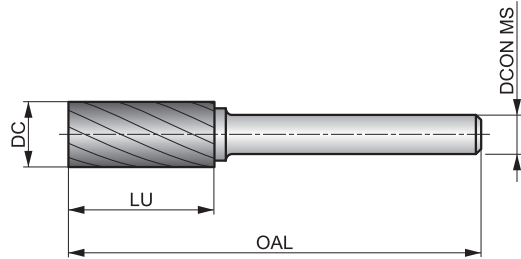

HM		Bright
VA		



Grupo de Material de la pieza adecuado. Velocidad operativa recomendada (RPM) en la pag. 277.

- | | | | | | | | | | | | |
|------|------|------|------|------|------|------|------|------|------|------|------|
| M1.1 | M1.2 | M2.1 | M2.2 | M2.3 | M3.1 | M3.2 | M3.3 | M4.1 | M4.2 | K4.1 | K4.2 |
| ■ | ■ | ■ | ■ | ■ | ■ | ■ | ■ | ■ | ■ | ▣ | ▣ |

DC ≤ 6.00 mm: DCON MS tolerancia h6; DC > 6.00 mm: soldada en un mango de acero con DCON MS tolerancia h7.
 Los productos de esta serie también están disponibles en forma de Set. Por favor, vea P880.

Product	DC (mm)	DCON MS (mm)	LU (mm)	OAL (mm)
P6013.0X3.0	3.00	3.00	14.00	38.0
P6016.3X3.0 ¹⁾	6.30	3.00	12.70	45.0
P6016.0X6.0	6.00	6.00	18.00	50.0
P6018.0X6.0 ¹⁾	8.00	6.00	19.00	64.0
P6019.6X6.0 ¹⁾	9.60	6.00	19.00	64.0
P60112.7X6.0 ¹⁾	12.70	6.00	25.00	70.0

¹⁾ Brazed on steel shank

P605



Lima Rotativa – Cilíndrica con Punta Esférica, Forma C

Lima rotativa tipo VA de un solo corte y espacio medio entre filos para recortar y desbarbar contornos y arcos circulares. Metal duro integral en diámetro Ø6 mm y por encima de 6 mm cabeza de metal duro en mango de acero endurecido. Primera elección para aceros inoxidables.

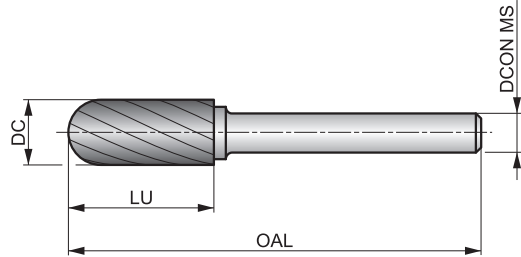

HM	C	Bright
VA		



Grupo de Material de la pieza adecuado. Velocidad operativa recomendada (RPM) en la pag. 277.

M1.1	M1.2	M2.1	M2.2	M2.3	M3.1	M3.2	M3.3	M4.1	M4.2	K4.1	K4.2
■	■	■	■	■	■	■	■	■	■	▣	▣

DC ≤ 6.00 mm: DCON MS tolerancia h6; DC > 6.00 mm: soldada en un mango de acero con DCON MS tolerancia h7.
Los productos de esta serie también están disponibles en forma de Set. Por favor, vea P880.

Product	DC (mm)	DCON MS (mm)	LU (mm)	OAL (mm)
P6053.0X3.0	3.00	3.00	14.00	38.0
P6056.3X3.0 ¹⁾	6.30	3.00	12.70	45.0
P6056.0X6.0	6.00	6.00	18.00	50.0
P6058.0X6.0 ¹⁾	8.00	6.00	19.00	64.0
P6059.6X6.0 ¹⁾	9.60	6.00	19.00	64.0
P60512.7X6.0 ¹⁾	12.70	6.00	25.00	70.0

¹⁾ Brazed on steel shank

P607



Lima Rotativa – Esférica, Forma D

Lima rotativa tipo VA de un solo corte y espacio medio entre filos para tallado intrincado, grabado en metales y preparación para soldadura. Metal duro integral en diámetro Ø6 mm y por encima de 6 mm cabeza de metal duro en mango de acero endurecido. Primera elección para aceros inoxidables.

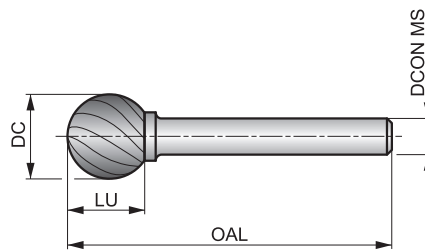

HM		Bright
VA		



Grupo de Material de la pieza adecuado. Velocidad operativa recomendada (RPM) en la pag. 277.

M1.1	M1.2	M2.1	M2.2	M2.3	M3.1	M3.2	M3.3	M4.1	M4.2	K4.1	K4.2
■	■	■	■	■	■	■	■	■	■	□	□

DC ≤ 6.00 mm: DCON MS tolerancia h6; DC > 6.00 mm: soldada en un mango de acero con DCON MS tolerancia h7.
Los productos de esta serie también están disponibles en forma de Set. Por favor, vea P880.

Product	DC (mm)	DCON MS (mm)	LU (mm)	OAL (mm)
P6073.0X3.0	3.00	3.00	2.50	38.0
P6076.3X3.0 ¹⁾	6.30	3.00	5.00	38.0
P6076.0X6.0	6.00	6.00	4.70	50.0
P6078.0X6.0 ¹⁾	8.00	6.00	6.00	52.0
P6079.6X6.0 ¹⁾	9.60	6.00	8.00	54.0
P60712.7X6.0 ¹⁾	12.70	6.00	11.00	56.0

¹⁾ Brazed on steel shank

P609



Lima Rotativa – Ovalada, Forma E

Lima rotativa tipo VA de un solo corte y espacio medio entre filos para contorneado de esquinas redondas. Cabeza de metal duro en mango de acero endurecido. Primera elección para aceros inoxidables.

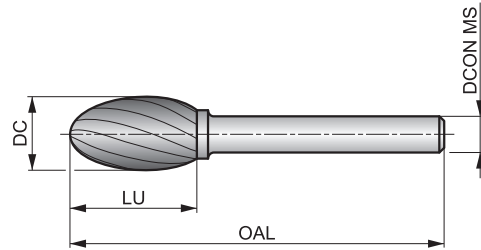

HM	E	Bright
VA		



Grupo de Material de la pieza adecuado. Velocidad operativa recomendada (RPM) en la pag. 277.

M1.1	M1.2	M2.1	M2.2	M2.3	M3.1	M3.2	M3.3	M4.1	M4.2	K4.1	K4.2
■	■	■	■	■	■	■	■	■	■	▣	▣

soldada en un mango de acero con DCON MS tolerancia h7.

Product	DC (mm)	DCON MS (mm)	LU (mm)	OAL (mm)
P6098.0X6.0 ¹⁾	8.00	6.00	15.00	60.0
P6099.6X6.0 ¹⁾	9.60	6.00	16.00	60.0
P60912.7X6.0 ¹⁾	12.70	6.00	22.00	67.0

¹⁾ Brazed on steel shank

P611



Lima Rotativa – Arbol con Punta Esférica, Forma F

Lima rotativa tipo VA de un solo corte y espacio medio entre filos para contorneado en múltiples ángulos, redondeado de esquinas y corte en áreas de difícil acceso. Metal duro integral en diámetro Ø6 mm y por encima de 6 mm cabeza de metal duro en mango de acero endurecido. Primera elección para aceros inoxidables.

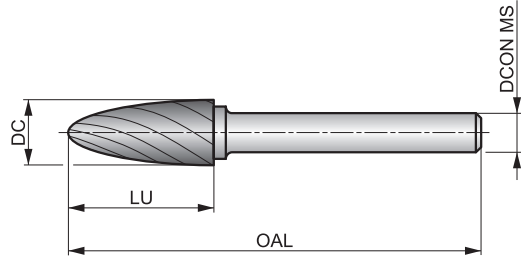

HM	F	Bright
VA		



Grupo de Material de la pieza adecuado. Velocidad operativa recomendada (RPM) en la pag. 277.

M1.1	M1.2	M2.1	M2.2	M2.3	M3.1	M3.2	M3.3	M4.1	M4.2	K4.1	K4.2
■	■	■	■	■	■	■	■	■	■	▣	▣

DC ≤ 6.00 mm: DCON MS tolerancia h6; DC > 6.00 mm: soldada en un mango de acero con DCON MS tolerancia h7.
Los productos de esta serie también están disponibles en forma de Set. Por favor, vea P880.

Product	DC (mm)	DCON MS (mm)	LU (mm)	OAL (mm)
P6113.0X3.0	3.00	3.00	14.00	38.0
P6116.3X3.0¹⁾	6.30	3.00	12.70	45.0
P6116.0X6.0	6.00	6.00	18.00	50.0
P6118.0X6.0¹⁾	8.00	6.00	20.00	65.0
P6119.6X6.0¹⁾	9.60	6.00	19.00	64.0
P61112.7X6.0¹⁾	12.70	6.00	25.00	70.0

¹⁾ Brazed on steel shank

P613



Lima Rotativa – Arbol con Punta, Forma G

Lima rotativa tipo VA de un solo corte y espacio medio entre filos para contorneado en múltiples ángulos y corte en áreas de difícil acceso. Metal duro integral en diámetro Ø6 mm y por encima de 6 mm cabeza de metal duro en mango de acero endurecido. Primera elección para aceros inoxidables.

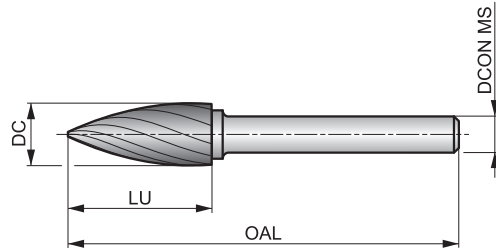

HM	G	Bright
VA		



Grupo de Material de la pieza adecuado. Velocidad operativa recomendada (RPM) en la pag. 277.

M1.1	M1.2	M2.1	M2.2	M2.3	M3.1	M3.2	M3.3	M4.1	M4.2	K4.1	K4.2
■	■	■	■	■	■	■	■	■	■	▣	▣

DC=6.00 mm: DCON MS tolerancia h6; DC > 6.00 mm: Soldada en un mango de acero con DCON MS tolerancia h7.

Product	DC (mm)	DCON MS (mm)	LU (mm)	OAL (mm)
P6136.0X6.0	6.00	6.00	18.00	50.0
P6138.0X6.0 ¹⁾	8.00	6.00	19.00	64.0
P6139.6X6.0 ¹⁾	9.60	6.00	19.00	64.0
P61312.7X6.0 ¹⁾	12.70	6.00	25.00	70.0

¹⁾ Brazed on steel shank

P615



Lima Rotativa – Llama, Forma H

Lima rotativa tipo VA de un solo corte y espacio medio entre filos para contorneado de esquinas redondas y preparación para soldadura. Cabeza de metal duro en mango de acero endurecido. Primera elección para aceros inoxidables.

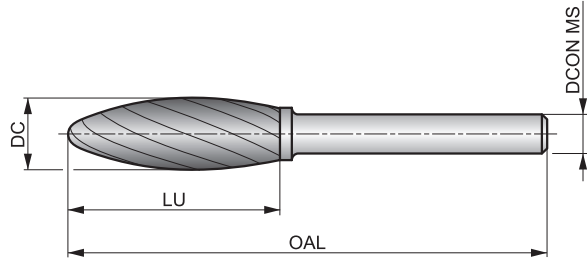

HM	H	Bright
VA	DORMER	



Grupo de Material de la pieza adecuado. Velocidad operativa recomendada (RPM) en la pag. 277.

M1.1	M1.2	M2.1	M2.2	M2.3	M3.1	M3.2	M3.3	M4.1	M4.2	K4.1	K4.2
■	■	■	■	■	■	■	■	■	■	▣	▣

soldada en un mango de acero con DCON MS tolerancia h7.

Product	DC (mm)	DCON MS (mm)	LU (mm)	OAL (mm)
P6158.0X6.0 ¹⁾	8.00	6.00	19.00	64.0
P6159.6X6.0 ¹⁾	9.60	6.00	19.00	65.0
P61512.7X6.0 ¹⁾	12.70	6.00	32.00	77.0

¹⁾ Brazed on steel shank

P621



Lima Rotativa – Cono con Punta Esférica, Forma L

Lima rotativa tipo VA de un solo corte y espacio medio entre filos para agrandar agujeros, redondear esquinas y acabado de superficies en ángulos cerrados y estrechos u otras áreas de difícil alcance. Cabeza de metal duro en mango de acero endurecido. Primera elección para aceros inoxidables.

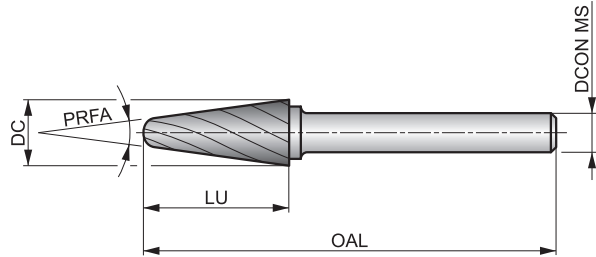

HM		Bright
VA		



Grupo de Material de la pieza adecuado. Velocidad operativa recomendada (RPM) en la pag. 277.

M1.1	M1.2	M2.1	M2.2	M2.3	M3.1	M3.2	M3.3	M4.1	M4.2	K4.1	K4.2
■	■	■	■	■	■	■	■	■	■	▣	▣

soldada en un mango de acero con DCON MS tolerancia h7.

Los productos de esta serie también están disponibles en forma de Set. Por favor, vea P880.

Product	DC (mm)	DCON MS (mm)	LU (mm)	OAL (mm)	PRFA (°)
P6218.0X6.0 ¹⁾	8.00	6.00	25.40	70.0	14
P62110.0X6.0 ¹⁾	10.00	6.00	20.00	65.0	14
P62112.7X6.0 ¹⁾	12.70	6.00	32.00	77.0	14

¹⁾ Brazed on steel shank

Código de Material (BMC)	HM	HM	HM	HM	HM	HM	HM	HM									
Código de Tipo de Lima Rotativa (BTC)	AL	AL	AL	AL	AL	AL	AL	GRP	GRP								
Forma de la Lima Rotativa																	
Recubrimiento	Bright	Bright	Bright	Bright	Bright	Bright	Bright	Bright	Bright								
Grupo básico estándar (BSG)																	
Ángulo de aplicación																	
Punta de la Lima Rotativa																	



Código de Familia de Producto	P831	P833	P835	P837	P841	P842	P843	P844									
Gama de diámetros de corte PSF	6.00 – 12.70	6.00 – 12.70	6.00 – 12.70	6.00 – 12.70	6.00 – 12.70	6.00 – 12.70	3.00 – 8.00	3.00 – 8.00									

P	P1																
	P2																
	P3																
	P4																
M	M1																
	M2																
	M3																
	M4																
K	K1																
	K2																
	K3																
	K4																
	K5																
N	N1	■	■	■	■	■	■										
	N2	■	■	■	■	■	■										
	N3	▣	▣	▣	▣	▣	▣										
	N4	■	■	■	■	■	■	■	■								
	N5																
S	S1	▣	▣	▣	▣	▣	▣										
	S2																
	S3																
	S4																
H	H1																
	H2																
	H3																
	H4																

P831



Lima Rotativa – Cilíndrica sin corte Frontal, Forma A

Lima rotativa tipo AL de un solo corte con filos muy espaciados para recortar y desbarbar superficies. Metal duro integral en diámetro Ø6 mm y por encima de 6 mm cabeza de metal duro en mango de acero endurecido. Primera elección para metales no férreos y plásticos.

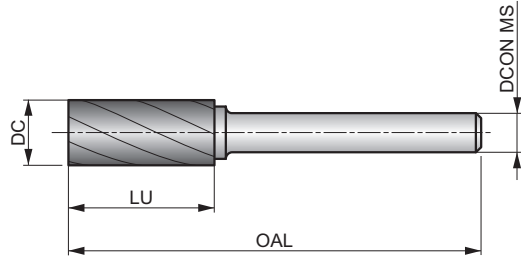

HM	A	Bright
AL		



Grupo de Material de la pieza adecuado. Velocidad operativa recomendada (RPM) en la pag. 277.

N1.1	N1.2	N1.3	N2.1	N2.2	N2.3	N3.1	N3.2	N4.1	N4.2	N4.3	S1.1
■	■	■	■	■	■	▣	▣	■	■	▣	▣

DC = 6.00 mm: DCON MS tolerancia h6; DC > 6.00 mm: Soldada en un mango de acero con DCON MS tolerancia h7.

Product	DC (mm)	DCON MS (mm)	LU (mm)	OAL (mm)
P8316.0X6.0	6.00	6.00	18.00	50.0
P8319.6X6.0 ¹⁾	9.60	6.00	19.00	64.0
P83112.7X6.0 ¹⁾	12.70	6.00	25.00	70.0

¹⁾ Brazed on steel shank

P833



Lima Rotativa – Cilíndrica con corte Frontal, Forma B

Lima rotativa tipo AL de un solo corte con filos muy espaciados para recortar y desbarbar superficies y esquinas a derecha. Metal duro integral en diámetro Ø6 mm y por encima de 6 mm cabeza de metal duro en mango de acero endurecido. Primera elección para metales no férricos y plásticos.

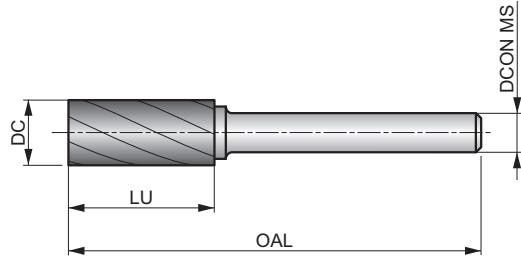

HM	B	
Bright	AL	



Grupo de Material de la pieza adecuado. Velocidad operativa recomendada (RPM) en la pag. 277.

- | | | | | | | | | | | | |
|------|------|------|------|------|------|------|------|------|------|------|------|
| N1.1 | N1.2 | N1.3 | N2.1 | N2.2 | N2.3 | N3.1 | N3.2 | N4.1 | N4.2 | N4.3 | S1.1 |
| ■ | ■ | ■ | ■ | ■ | ■ | ▣ | ▣ | ■ | ■ | ▣ | ▣ |

DC = 6.00 mm: DCON MS tolerancia h6; DC > 6.00 mm: Soldada en un mango de acero con DCON MS tolerancia h7.

Product	DC (mm)	DCON MS (mm)	LU (mm)	OAL (mm)
P8336.0X6.0	6.00	6.00	18.00	50.0
P8339.6X6.0 ¹⁾	9.60	6.00	19.00	64.0
P83312.7X6.0 ¹⁾	12.70	6.00	25.00	70.0

¹⁾ Brazed on steel shank

P835



Lima Rotativa – Cilíndrica con Punta Esférica, Forma C

Lima rotativa tipo AL de un solo corte con filos muy espaciados para recortar y desbarbar contornos y arcos circulares. Metal duro integral en diámetro Ø6 mm y por encima de 6 mm cabeza de metal duro en mango de acero endurecido. Primera elección para metales no féreos y plásticos.

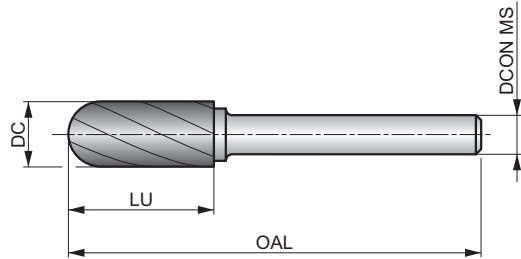

HM		Bright
AL		



Grupo de Material de la pieza adecuado. Velocidad operativa recomendada (RPM) en la pag. 277.

N1.1	N1.2	N1.3	N2.1	N2.2	N2.3	N3.1	N3.2	N4.1	N4.2	N4.3	S1.1
■	■	■	■	■	■	▣	▣	■	■	▣	▣

DC = 6.00 mm: DCON MS tolerancia h6; DC > 6.00 mm: Soldada en un mango de acero con DCON MS tolerancia h7.

Product	DC (mm)	DCON MS (mm)	LU (mm)	OAL (mm)
P8356.0X6.0	6.00	6.00	18.00	50.0
P8359.6X6.0 ¹⁾	9.60	6.00	19.00	64.0
P83512.7X6.0 ¹⁾	12.70	6.00	25.00	70.0

¹⁾ Brazed on steel shank

P837



Lima Rotativa – Esférica, Forma D

Lima rotativa tipo AL de un solo corte con filos muy espaciados para tallado intrincado, grabado en metales y preparación para soldadura. Metal duro integral en diámetro Ø6 mm y por encima de 6 mm cabeza de metal duro en mango de acero endurecido. Primera elección para metales no férricos y plásticos.

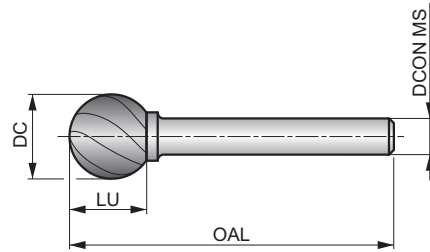

HM		Bright
AL		



Grupo de Material de la pieza adecuado. Velocidad operativa recomendada (RPM) en la pag. 277.

N1.1	N1.2	N1.3	N2.1	N2.2	N2.3	N3.1	N3.2	N4.1	N4.2	N4.3	S1.1
■	■	■	■	■	■	▣	▣	■	■	▣	▣

DC = 6.00 mm: DCON MS tolerancia h6; DC > 6.00 mm: Soldada en un mango de acero con DCON MS tolerancia h7.

Product	DC (mm)	DCON MS (mm)	LU (mm)	OAL (mm)
P8376.0X6.0	6.00	6.00	4.70	50.0
P8379.6X6.0 ¹⁾	9.60	6.00	8.00	54.0
P83712.7X6.0 ¹⁾	12.70	6.00	11.00	56.0

¹⁾ Brazed on steel shank

P841



Lima Rotativa – Arbol con Punta Esférica, Forma F

Lima rotativa tipo AL de un solo corte con filos muy espaciados para contorneado en múltiples ángulos, redondeo de esquinas y corte en áreas de difícil acceso. Metal duro integral en diámetro Ø6 mm y por encima de 6 mm cabeza de metal duro en mango de acero endurecido. Primera elección para metales no féreos y plásticos.

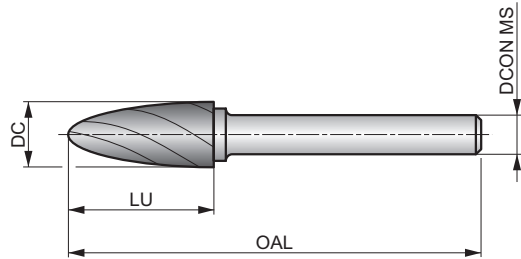

HM	F	Bright
AL		



Grupo de Material de la pieza adecuado. Velocidad operativa recomendada (RPM) en la pag. 277.

N1.1	N1.2	N1.3	N2.1	N2.2	N2.3	N3.1	N3.2	N4.1	N4.2	N4.3	S1.1
■	■	■	■	■	■	▣	▣	■	■	▣	▣

DC = 6.00 mm: DCON MS tolerancia h6; DC > 6.00 mm: Soldada en un mango de acero con DCON MS tolerancia h7.

Product	DC (mm)	DCON MS (mm)	LU (mm)	OAL (mm)
P8416.0X6.0	6.00	6.00	18.00	50.0
P8419.6X6.0 ¹⁾	9.60	6.00	19.00	64.0
P84112.7X6.0 ¹⁾	12.70	6.00	25.00	70.0

¹⁾ Brazed on steel shank

P842



Lima Rotativa – Cono con Punta Esférica, Forma L

Lima rotativa tipo AL de un solo corte con filos muy espaciados para agrandar agujeros, redondear esquinas y acabado de superficies en ángulos cerrados y estrechos u otras áreas de difícil alcance. Metal duro integral en diámetro Ø6 mm y por encima de 6 mm cabeza de metal duro en mango de acero endurecido. Primera elección para metales no férreos y plásticos.

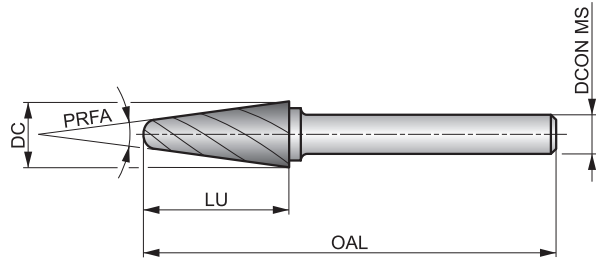

HM		Bright
AL		



Grupo de Material de la pieza adecuado. Velocidad operativa recomendada (RPM) en la pag. 277.

N1.1	N1.2	N1.3	N2.1	N2.2	N2.3	N3.1	N3.2	N4.1	N4.2	N4.3	S1.1
■	■	■	■	■	■	▣	▣	■	■	▣	▣

DC = 6.00 mm: DCON MS tolerancia h6; DC > 6.00 mm: Soldada en un mango de acero con DCON MS tolerancia h7.

Product	DC (mm)	DCON MS (mm)	LU (mm)	OAL (mm)	PRFA (°)
P8426.0X6.0	6.00	6.00	18.00	50.0	14
P8429.6X6.0 ¹⁾	9.60	6.00	30.00	76.0	14
P84212.7X6.0 ¹⁾	12.70	6.00	32.00	77.0	14

¹⁾ Brazed on steel shank

P843



Fresa con Corte de diamante – Ángulo de punta a 135°

Lima rotativa tipo GRP con corte de diamante y espacio medio entre filos para contorneado, recortar formas y hacer agujeros. Mango de metal duro para proporcionar rigidez. Primera elección para fibra de vidrio composites.

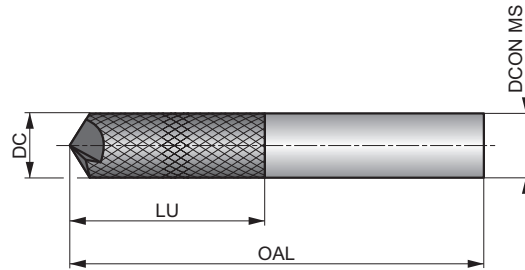

 HM	 Bright
 135°	 GRP



Grupo de Material de la pieza adecuado. Velocidad operativa recomendada (RPM) en la pag. 277.

N4.3

DCON MS tolerancia h6.

Product	DC (mm)	DCON MS (mm)	LU (mm)	OAL (mm)
P8433.0X3.0	3.00	3.00	13.00	45.0
P8436.0X6.0	6.00	6.00	19.00	63.0
P8438.0X8.0	8.00	8.00	25.00	63.0

P844



Fresa con Corte de diamante

Lima rotativa tipo GRP con corte de diamante y espacio medio entre filos para contorneado, ranurado, fresado de cavidades y recortar formas. Mango de metal duro para proporcionar rigidez. Primera elección para fibra de vidrio composites.

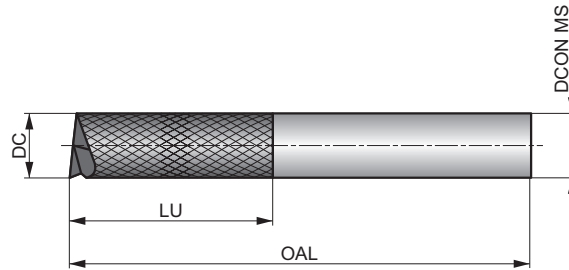

HM		Bright
	GRP	



Grupo de Material de la pieza adecuado. Velocidad operativa recomendada (RPM) en la pag. 277.

N4.3

DCON MS tolerancia h6.

Product	DC (mm)	DCON MS (mm)	LU (mm)	OAL (mm)
P8443.0X3.0	3.00	3.00	13.00	45.0
P8446.0X6.0	6.00	6.00	19.00	63.0
P8448.0X8.0	8.00	8.00	25.00	63.0

		HM	HM	HM	HM	HM	HM	HM	HM						
Código de Material (BMC)		HM	HM	HM	HM	HM	HM	HM	HM						
Código de Tipo de Lima Rotativa (BTC)		AS	AS	AS	AS	AS	AS	AS	AS						
Forma de la Lima Rotativa															
Recubrimiento		Bright	Bright	Bright	Bright	Bright	Bright	Bright	Bright	Bright					
Grupo básico estándar (BSG)															
Código de Familia de Producto		P501	P505	P507	P509	P511	P513	P515	P521	P523					
Gama de diámetros de corte PSF		3.00	3.00	3.00	3.00	3.00	3.00	3.00	3.00	3.00					
		234	235	236	237	238	239	240	241	242					
P	P1														
	P2														
	P3														
	P4														
M	M1														
	M2														
	M3	<input checked="" type="checkbox"/>	<input checked="" type="checkbox"/>	<input checked="" type="checkbox"/>	<input checked="" type="checkbox"/>	<input checked="" type="checkbox"/>	<input checked="" type="checkbox"/>	<input checked="" type="checkbox"/>	<input checked="" type="checkbox"/>	<input checked="" type="checkbox"/>					
	M4	<input checked="" type="checkbox"/>	<input checked="" type="checkbox"/>	<input checked="" type="checkbox"/>	<input checked="" type="checkbox"/>	<input checked="" type="checkbox"/>	<input checked="" type="checkbox"/>	<input checked="" type="checkbox"/>	<input checked="" type="checkbox"/>	<input checked="" type="checkbox"/>					
K	K1														
	K2														
	K3														
	K4														
	K5														
N	N1														
	N2														
	N3														
	N4														
	N5														
S	S1	<input checked="" type="checkbox"/>	<input checked="" type="checkbox"/>	<input checked="" type="checkbox"/>	<input checked="" type="checkbox"/>	<input checked="" type="checkbox"/>	<input checked="" type="checkbox"/>	<input checked="" type="checkbox"/>	<input checked="" type="checkbox"/>	<input checked="" type="checkbox"/>					
	S2	<input checked="" type="checkbox"/>	<input checked="" type="checkbox"/>	<input checked="" type="checkbox"/>	<input checked="" type="checkbox"/>	<input checked="" type="checkbox"/>	<input checked="" type="checkbox"/>	<input checked="" type="checkbox"/>	<input checked="" type="checkbox"/>	<input checked="" type="checkbox"/>					
	S3	<input checked="" type="checkbox"/>	<input checked="" type="checkbox"/>	<input checked="" type="checkbox"/>	<input checked="" type="checkbox"/>	<input checked="" type="checkbox"/>	<input checked="" type="checkbox"/>	<input checked="" type="checkbox"/>	<input checked="" type="checkbox"/>	<input checked="" type="checkbox"/>					
	S4	<input checked="" type="checkbox"/>	<input checked="" type="checkbox"/>	<input checked="" type="checkbox"/>	<input checked="" type="checkbox"/>	<input checked="" type="checkbox"/>	<input checked="" type="checkbox"/>	<input checked="" type="checkbox"/>	<input checked="" type="checkbox"/>	<input checked="" type="checkbox"/>					
H	H1														
	H2														
	H3														
	H4														

P501



Lima Rotativa – Cilíndrica sin Corte Frontal, Forma A

Lima rotativa tipo AS de un solo corte con corte transversal ligeramente a la izquierda para recortar y desbarbar superficies. Mango de metal duro para mayor rigidez. Primera elección para superaleaciones termorresistentes.

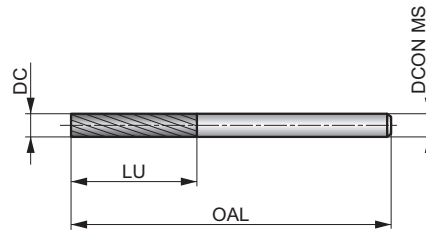

HM		Bright
AS		



Grupo de Material de la pieza adecuado. Velocidad operativa recomendada (RPM) en la pag. 277.

M3.1	M3.2	M3.3	M4.1	M4.2	S1.1	S1.2	S1.3	S2.1	S2.2	S3.1	S3.2	S4.1	S4.2
<input checked="" type="checkbox"/>	<input checked="" type="checkbox"/>	<input checked="" type="checkbox"/>	<input checked="" type="checkbox"/>	<input checked="" type="checkbox"/>	<input type="checkbox"/>	<input type="checkbox"/>	<input type="checkbox"/>	<input type="checkbox"/>	<input type="checkbox"/>	<input type="checkbox"/>	<input type="checkbox"/>	<input type="checkbox"/>	<input type="checkbox"/>

DCON MS tolerancia h6.

Los productos de esta serie también están disponibles en forma de Set. Por favor, vea P880.

Product	DC (mm)	DCON MS (mm)	LU (mm)	OAL (mm)
P5013.0X3.0	3.00	3.00	12.00	38.0

P505



Lima Rotativa – Cilíndrica con Punta Esférica, Forma C

Lima rotativa tipo AS de un solo corte con corte transversal ligeramente a la izquierda para recortar y desbarbar contornos y arcos circulares. Mango de metal duro para mayor rigidez. Primera elección para superaleaciones termorresistentes.

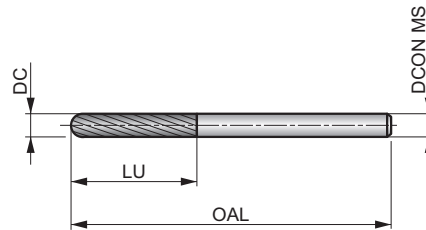

HM	C	Bright
AS		



Grupo de Material de la pieza adecuado. Velocidad operativa recomendada (RPM) en la pag. 277.

M3.1	M3.2	M3.3	M4.1	M4.2	S1.1	S1.2	S1.3	S2.1	S2.2	S3.1	S3.2	S4.1	S4.2
<input checked="" type="checkbox"/>	<input checked="" type="checkbox"/>	<input checked="" type="checkbox"/>	<input checked="" type="checkbox"/>	<input checked="" type="checkbox"/>	<input type="checkbox"/>	<input type="checkbox"/>	<input type="checkbox"/>	<input type="checkbox"/>	<input type="checkbox"/>	<input type="checkbox"/>	<input type="checkbox"/>	<input type="checkbox"/>	<input type="checkbox"/>

DCON MS tolerancia h6.

Los productos de esta serie también están disponibles en forma de Set. Por favor, vea P880.

Product	DC (mm)	DCON MS (mm)	LU (mm)	OAL (mm)
P5053.0X3.0	3.00	3.00	14.00	38.0

P507



Lima Rotativa – Esférica, Forma D

Lima rotativa tipo AS de un solo corte con corte transversal ligeramente a la izquierda para tallado intrincado, grabado en metales y preparación para soldadura. Mango de metal duro para mayor rigidez. Primera elección para superaleaciones termorresistentes.

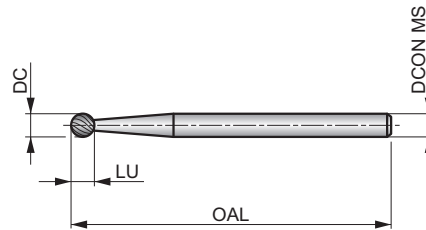

HM		Bright
AS		



Grupo de Material de la pieza adecuado. Velocidad operativa recomendada (RPM) en la pag. 277.

M3.1	M3.2	M3.3	M4.1	M4.2	S1.1	S1.2	S1.3	S2.1	S2.2	S3.1	S3.2	S4.1	S4.2
<input checked="" type="checkbox"/>	<input checked="" type="checkbox"/>	<input checked="" type="checkbox"/>	<input checked="" type="checkbox"/>	<input checked="" type="checkbox"/>	<input type="checkbox"/>	<input type="checkbox"/>	<input type="checkbox"/>	<input type="checkbox"/>	<input type="checkbox"/>	<input type="checkbox"/>	<input type="checkbox"/>	<input type="checkbox"/>	<input type="checkbox"/>

DCON MS tolerancia h6.
Los productos de esta serie también están disponibles en forma de Set. Por favor, vea P880.

Product	DC (mm)	DCON MS (mm)	LU (mm)	OAL (mm)
P5073.0X3.0	3.00	3.00	2.50	38.0

P509



Lima Rotativa – Ovalada, Forma E

Lima rotativa tipo AS de un solo corte con corte transversal ligeramente a la izquierda para contorneado de esquinas redondas. Mango de metal duro para mayor rigidez. Primera elección para superaleaciones termorresistentes.

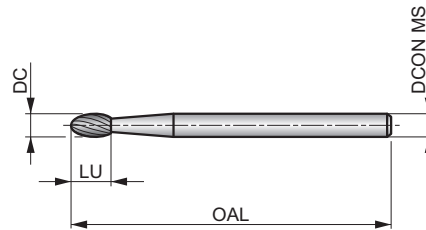

HM	E	Bright
AS		



Grupo de Material de la pieza adecuado. Velocidad operativa recomendada (RPM) en la pag. 277.

M3.1	M3.2	M3.3	M4.1	M4.2	S1.1	S1.2	S1.3	S2.1	S2.2	S3.1	S3.2	S4.1	S4.2
<input checked="" type="checkbox"/>	<input checked="" type="checkbox"/>	<input checked="" type="checkbox"/>	<input checked="" type="checkbox"/>	<input checked="" type="checkbox"/>	<input type="checkbox"/>	<input type="checkbox"/>	<input type="checkbox"/>	<input type="checkbox"/>	<input type="checkbox"/>	<input type="checkbox"/>	<input type="checkbox"/>	<input type="checkbox"/>	<input type="checkbox"/>

DCON MS tolerancia h6.
Los productos de esta serie también están disponibles en forma de Set. Por favor, vea P880.

Product	DC (mm)	DCON MS (mm)	LU (mm)	OAL (mm)
P5093.0X3.0	3.00	3.00	6.00	38.0

P511



Lima Rotativa – Arbol con Punta Esférica, Forma F

Lima rotativa tipo AS de un solo corte con corte transversal ligeramente a la izquierda para contorneado en múltiples ángulos, redondeo de esquinas y corte en áreas de difícil acceso. Mango de metal duro para mayor rigidez. Primera elección para superaleaciones termorresistentes.

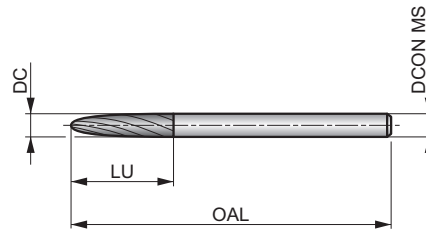

HM	F	Bright
AS		



Grupo de Material de la pieza adecuado. Velocidad operativa recomendada (RPM) en la pag. 277.

M3.1	M3.2	M3.3	M4.1	M4.2	S1.1	S1.2	S1.3	S2.1	S2.2	S3.1	S3.2	S4.1	S4.2
<input checked="" type="checkbox"/>	<input checked="" type="checkbox"/>	<input checked="" type="checkbox"/>	<input checked="" type="checkbox"/>	<input checked="" type="checkbox"/>	<input type="checkbox"/>	<input type="checkbox"/>	<input type="checkbox"/>	<input type="checkbox"/>	<input type="checkbox"/>	<input type="checkbox"/>	<input type="checkbox"/>	<input type="checkbox"/>	<input type="checkbox"/>

DCON MS tolerancia h6.

Los productos de esta serie también están disponibles en forma de Set. Por favor, vea P880.

Product	DC (mm)	DCON MS (mm)	LU (mm)	OAL (mm)
P5113.0X3.0	3.00	3.00	14.00	38.0

P513



Lima Rotativa – Arbol con Punta, Forma G

Lima rotativa tipo AS de un solo corte con corte transversal ligeramente a la izquierda para contorneado en múltiples ángulos y corte en áreas de difícil acceso. Mango de metal duro para mayor rigidez. Primera elección para superaleaciones termorresistentes.

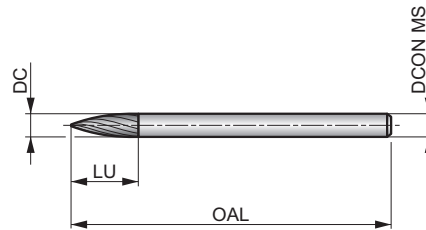

HM	G	Bright
AS		



Grupo de Material de la pieza adecuado. Velocidad operativa recomendada (RPM) en la pag. 277.

M3.1	M3.2	M3.3	M4.1	M4.2	S1.1	S1.2	S1.3	S2.1	S2.2	S3.1	S3.2	S4.1	S4.2
<input checked="" type="checkbox"/>	<input checked="" type="checkbox"/>	<input checked="" type="checkbox"/>	<input checked="" type="checkbox"/>	<input checked="" type="checkbox"/>	<input type="checkbox"/>	<input type="checkbox"/>	<input type="checkbox"/>	<input type="checkbox"/>	<input type="checkbox"/>	<input type="checkbox"/>	<input type="checkbox"/>	<input type="checkbox"/>	<input type="checkbox"/>

DCON MS tolerancia h6.

Los productos de esta serie también están disponibles en forma de Set. Por favor, vea P880.

Product	DC (mm)	DCON MS (mm)	LU (mm)	OAL (mm)
P5133.0X3.0X8.0	3.00	3.00	8.00	38.0
P5133.0X3.0X14.0	3.00	3.00	14.00	38.0

P515



Lima Rotativa – Llama, Forma H

Lima rotativa tipo AS de un solo corte con corte transversal ligeramente a la izquierda para contorneado de esquinas redondas y preparación para soldadura. Mango de metal duro para mayor rigidez. Primera elección para superaleaciones termorresistentes.

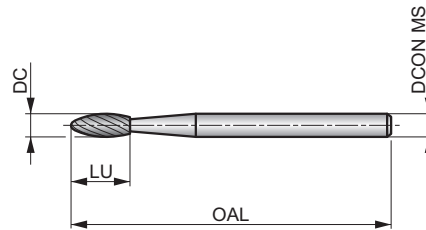

HM	H	Bright
AS	DORMER	



Grupo de Material de la pieza adecuado. Velocidad operativa recomendada (RPM) en la pag. 277.

M3.1	M3.2	M3.3	M4.1	M4.2	S1.1	S1.2	S1.3	S2.1	S2.2	S3.1	S3.2	S4.1	S4.2
☑	☑	☑	☑	☑	☐	☐	☐	☐	☐	☐	☐	☐	☐

DCON MS tolerancia h6.

Los productos de esta serie también están disponibles en forma de Set. Por favor, vea P880.

Product	DC (mm)	DCON MS (mm)	LU (mm)	OAL (mm)
P5153.0X3.0	3.00	3.00	6.00	38.0

P521



Lima Rotativa – Cono con Punta Esférica, Forma L

Lima rotativa tipo AS de un solo corte con corte transversal ligeramente a la izquierda para agrandar agujeros, redondear esquinas y acabado de superficies en ángulos estrechos u otras áreas de difícil acceso. Mango de metal duro para mayor rigidez. Primera elección para superaleaciones termostables.

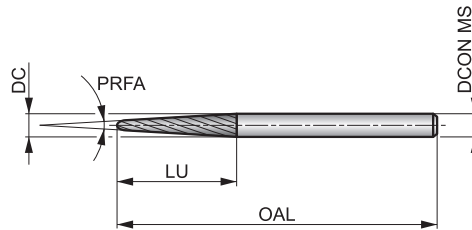

HM		Bright				
AS						

Grupo de Material de la pieza adecuado. Velocidad operativa recomendada (RPM) en la pag. 277.

M3.1	M3.2	M3.3	M4.1	M4.2	S1.1	S1.2	S1.3	S2.1	S2.2	S3.1	S3.2	S4.1	S4.2
<input checked="" type="checkbox"/>	<input checked="" type="checkbox"/>	<input checked="" type="checkbox"/>	<input checked="" type="checkbox"/>	<input checked="" type="checkbox"/>	<input type="checkbox"/>	<input type="checkbox"/>	<input type="checkbox"/>	<input type="checkbox"/>	<input type="checkbox"/>	<input type="checkbox"/>	<input type="checkbox"/>	<input type="checkbox"/>	<input type="checkbox"/>

DCON MS tolerancia h6.

Los productos de esta serie también están disponibles en forma de Set. Por favor, vea P880.

Product	DC (mm)	DCON MS (mm)	LU (mm)	OAL (mm)	PRFA (°)
P5213.0X3.0	3.00	3.00	14.00	38.0	8

P523



Lima Rotativa – Cono, Forma M

Lima rotativa tipo AS de un solo corte con corte transversal ligeramente a la izquierda para agrandar agujeros, acabado de superficies y cote en ángulos estrechos u otras áreas de difícil acceso. Mango de metal duro para mayor rigidez. Primera elección para superaleaciones termorresistentes.

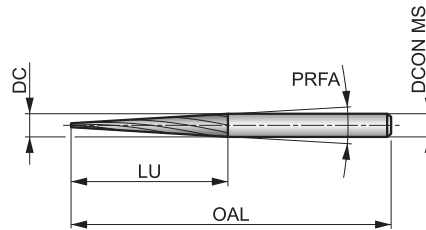

HM	M	Bright
AS		



Grupo de Material de la pieza adecuado. Velocidad operativa recomendada (RPM) en la pag. 277.

M3.1	M3.2	M3.3	M4.1	M4.2	S1.1	S1.2	S1.3	S2.1	S2.2	S3.1	S3.2	S4.1	S4.2
<input checked="" type="checkbox"/>	<input checked="" type="checkbox"/>	<input checked="" type="checkbox"/>	<input checked="" type="checkbox"/>	<input checked="" type="checkbox"/>	<input type="checkbox"/>	<input type="checkbox"/>	<input type="checkbox"/>	<input type="checkbox"/>	<input type="checkbox"/>	<input type="checkbox"/>	<input type="checkbox"/>	<input type="checkbox"/>	<input type="checkbox"/>

DCON MS tolerancia h6.
Los productos de esta serie también están disponibles en forma de Set. Por favor, vea P880.

Product	DC (mm)	DCON MS (mm)	LU (mm)	OAL (mm)	PRFA (°)
P5233.0X3.0	3.00	3.00	15.00	38.0	7

Código de Material (BMC)	HM	HM	HM	HM					
Código de Tipo de Lima Rotativa (BTC)			BR	BR					
Recubrimiento			Bright	Bright					
Grupo básico estándar (BSG)			DORMER	DORMER					
Ángulo de aplicación				150°					
Punta de la Lima Rotativa									

Código de Familia de Producto		P880	P890	P100	P101	M902				
Gama de diámetros de corte PSF		Set	Set	4.90 – 10.70	4.90 – 10.70	Set				
		244	245	246	247	248				
P	P1			■	■					
	P2			■	■					
	P3			■	■					
	P4			■	■					
M	M1			■	■					
	M2			■	■					
	M3			■	■					
	M4									
K	K1									
	K2									
	K3									
	K4									
	K5									
N	N1									
	N2									
	N3									
	N4									
	N5									
S	S1									
	S2									
	S3									
	S4									
H	H1									
	H2									
	H3									
	H4									

P880



Juego de Limas Rotativas

Juego con varias limas rotativas en diferentes formas y tamaños.

A = Tipos del Juego, B = No del Juego, C = Limas Rotativas en el Juego

Product	Nr.	A	B	C
P88001	Nr01	P803 + P805 + P807 + P809 + P813	5	P8039.6X6.0; P8059.6X6.0; P8079.6X6.0; P8099.6X6.0; P8139.6X6.0
P88002	Nr02	P803C + P805C + P807C + P811C + P813C	5	P803C9.6X6.0; P805C9.6X6.0; P807C9.6X6.0; P811C9.6X6.0; P813C9.6X6.0
P88003	Nr03	P601 + P605 + P607 + P611 + P621	5	P6019.6X6.0; P6059.6X6.0; P6079.6X6.0; P6119.6X6.0; P62110.0X6.0
P88004	Nr04	P703 + P705 + P707 + P711 + P721	5	P7039.6X6.0; P7059.6X6.0; P7079.6X6.0; P7119.6X6.0; P72110.0X6.0
P88006	Nr06	P501 + P505 + P507 + P509 + P511 + P513 + P515 + P521 + P523	10	P5013.0x3.0; P5053.0x3.0; P5073.0x3.0; P5093.0x3.0; P5113.0x3.0; P5133.0x3.0x8.0; P5133.0x3.0x14.0; P5153.0x3.0; P5213.0x3.0; P5233.0x3.0

P890



Lima Rotativa - Expositor

Expositor de 40 piezas para limas rotativas de la serie P8xx, tipo DC de doble corte con espacio reducido entre filos. Acabado brillante.

A = Tipos del Juego, B = No del Juego, C = Limas Rotativas en el Juego

Product	Nr.	A	B	C
P89001EMPTY	-	-	-	-
P89001	Nr01	P803 + P805 + P811 + P813 + P821	40	P803(6.0X6.0; 8.0X6.0; 9.6X6.0; 12.7X6.0) X 2; P805(6.0X6.0; 8.0X6.0; 9.6X6.0; 12.7X6.0) X 2; P811(6.0X6.0; 8.0X6.0; 9.6X6.0; 12.7X6.0) X 2; P813(6.0X6.0; 8.0X6.0; 9.6X6.0; 12.7X6.0) X 2; P821(6.0X6.0; 8.0X6.0; 9.6X6.0; 12.7X6.0) X 2

P100



Lima Rotativa Paso 1 para Extracción de Tornillos Rotos, Cilíndrica solo con corte Frontal

Lima rotativa Paso 1 de metal duro para extracción de tornillos rotos. Cuando un tornillo se rompe en el interior de un agujero roscado y es necesario extraerlo, utilice primero P100 para planear la superficie del tornillo roto. En segundo lugar utilice P101. Esta serie de herramientas asegura que la rosca del agujero no sufre daños cuando se extrae la pieza rota.

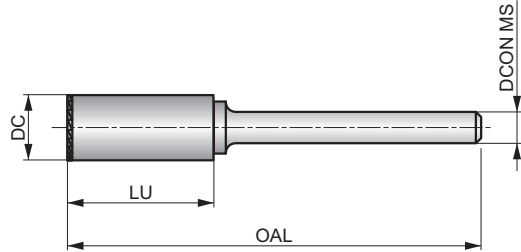

HM		Bright
BR		



Grupo de Material de la pieza adecuado. Velocidad operativa recomendada (RPM) en la pag. 277.

P1.1	P1.2	P1.3	P2.1	P2.2	P2.3	P3.1	P3.2	P3.3	P4.1	P4.2	M1.1	M1.2	M2.1
■	■	■	■	■	■	■	■	■	■	■	■	■	■
M2.2	M2.3	M3.1	M3.2	M3.3									
■	■	■	■	■									

Product	DC (mm)	DCON MS (mm)	LU (mm)	OAL (mm)	
P1004.9	4.90	6.00	20.00	50.0	1/4-20; 24; 28; M6
P1006.4	6.40	6.00	5.00	50.0	5/16-18; 24; 32; M8
P1007.8	7.80	6.00	19.00	65.0	3/8-16; 24; M10
P1009.3	9.30	6.00	19.00	65.0	7/16-14; 20; M12
P10010.7	10.70	6.00	25.00	70.0	1/2-13; 20; M14

P101



Lima Rotativa Paso 2 para Extracción de Tornillos Rotos, Cónica a 150°

Lima rotativa Paso 2 de metal duro para extracción de tornillos rotos. Cuando un tornillo se rompe en el interior de un agujero roscado y es necesario extraerlo, P101 genera un punto para centrado en la superficie del tornillo roto, previamente aplanada por P100. Lo prepara para el Paso 3, que consiste en taladrar el tornillo roto con una broca.

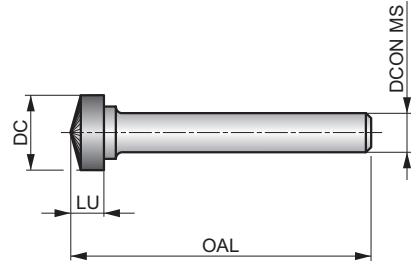

HM	Bright	150°
BR	DORMER	



Grupo de Material de la pieza adecuado. Velocidad operativa recomendada (RPM) en la pag. 277.

P1.1	P1.2	P1.3	P2.1	P2.2	P2.3	P3.1	P3.2	P3.3	P4.1	P4.2	M1.1	M1.2	M2.1
■	■	■	■	■	■	■	■	■	■	■	■	■	■
M2.2	M2.3	M3.1	M3.2	M3.3									
■	■	■	■	■									

Product	DC (mm)	DCON MS (mm)	LU (mm)	OAL (mm)	
P1014.9	4.90	6.00	20.00	50.0	1/4-20; 24; 28; M6
P1016.4	6.40	6.00	5.00	50.0	5/16-18; 24; 32; M8
P1017.8	7.80	6.00	5.00	50.0	3/8-16; 24; M10
P1019.3	9.30	6.00	5.00	50.0	7/16-14; 20; M12
P10110.7	10.70	6.00	5.00	50.0	1/2-13; 20; M14



M902

DORMER



Kit de extracción de tornillos

Las herramientas para extraer tornillos rotos a derecha vienen en juegos de cuatro. En primer lugar, se utiliza la lima rotativa P100 para aplanar el perno. En segundo lugar, se utiliza la lima rotativa P101 para crear un cono de inicio. En tercer lugar, se utiliza la broca extracorta HSS-E A117 para taladrar un agujero para el extractor. Finalmente, se utiliza el extractor de tornillos con un giro en sentido antihorario para extraer el perno roto sin dañar las roscas.

A = Tipos en el Juego, B = No en el Juego, C = Diámetros en el Juego

Product	Nr.	A	B	C
M902M6-M8	M6 – M8	M900, P100, P101, A117	4	P1004.9, P1014.9, A1173.0, M9002
M902M8-M10	M8 – M10	M900, P100, P101, A117	4	P1006.4, P1016.4, A1174.0, M9003
M902M10-M12	M10 – M12	M900, P100, P101, A117	4	P1007.8, P1017.8, A1174.2, M9003
M902M12-M14	M12 – M14	M900, P100, P101, A117	4	P1009.3, P1019.3, A1176.0, M9004
M902M14-M16	M14 – M16	M900, P100, P101, A117	4	P10010.7, P10110.7, A1178.0, M9005



INSTRUCCIONES

FRESAS INTEGRALES – PÁGINA RESUMEN

1 S771HB



2 Fresa de Metal Duro de 5 Filos con Divisores de viruta y Refrigeración Interna

Fresa con longitud de corte corta de 5 fillos con cuello reducido y hélice desigual que ayuda a reducir vibraciones, especialmente al utilizarla con estrategias de fresado dinámico. El recubrimiento AlCrN aumenta la vida de la herramienta y mejora el rendimiento. Rompevirutas y refrigeración interna para mejorar la evacuación de viruta en operaciones de cajeadado.

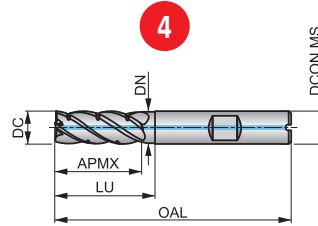

HM	FS	NOF 5
	$\lambda \neq$	$\gamma 10^\circ$
DIN 6535HB	AlCrN	DC h9



Grupo de Material de la pieza adecuado. Valores de inicio de la velocidad de corte (m/min) y código alfabético. Las tablas con avances por diente y factores de corrección en la pag. 266.

P1.1 ■ 222 J	P1.2 ■ 248 J	P1.3 ■ 255 J	P2.1 ■ 189 J	P2.2 ■ 166 J	P2.3 ■ 147 I	P3.1 ■ 153 J	P3.2 ■ 123 I	P3.3 ■ 104 I	P4.1 ■ 90 I	P4.2 ■ 78 I	M1.1 ■ 128 I	M1.2 ■ 108 I	M2.1 ■ 113 I
M2.2 ■ 93 I	M3.1 ■ 105 I	M3.2 ■ 90 I	K1.1 ■ 218 J	K1.2 ■ 162 J	K1.3 ■ 122 J	K2.1 ■ 225 J	K2.2 ■ 183 J	K2.3 ■ 146 I	K3.1 ■ 198 J	K3.2 ■ 152 I	K3.3 ■ 123 I	K4.1 ■ 185 I	K4.2 ■ 139 I
K4.3 ■ 102 I	K4.4 ■ 87 I	K4.5 ■ 72 I	K5.1 ■ 209 I	K5.2 ■ 156 I	K5.3 ■ 122 I	S1.2 ■ 76 I	S2.1 ■ 59 I	S3.1 ■ 44 G	S4.1 ■ 35 G				

DCON MS tolerancia h6; RE ±0.01 mm.

Product	DC (mm)	RE (mm)	DCON MS (mm)	APMX (mm)	OAL (mm)	NOF	LU (mm)	DN (mm)
S771HB10.0	10.00	0.20	10.00	25.00	72.0	5	30.00	9.70
S771HB12.0	12.00	0.20	12.00	30.00	83.0	5	38.00	11.70
S771HB16.0	16.00	0.30	16.00	39.00	92.0	5	44.00	15.70
S771HB20.0	20.00	0.30	20.00	48.00	104.0	5	54.00	19.70

Pos.	Descripción
1	Denominación de la fresa integral
2	Descripción del producto
3	Imagen
4	Representación esquemática de la herramienta
5	Características del producto



Pos.	Descripción
6	Operaciones de fresado
7	Recomendaciones de grupos de materiales, incluidas la velocidad de corte y la guía de avance
8	Código de producto
9	Dimensiones del producto

RESUMEN DE SÍMBOLOS

Símbolos generales

<input type="checkbox"/>	Uso principal	<input checked="" type="checkbox"/>	Uso posible
--------------------------	---------------	-------------------------------------	-------------





Perfil de la fresa

N	Fresa de uso general para materiales de baja a alta resistencia	NRA	Rompevirutas con perfil asimétrico redondeado de paso grande		Paso fino
FS	Rompevirutas con perfil de semiacabado	NR	Rompevirutas con perfil redondeado de paso grande		Paso grande
HRA	Rompevirutas con perfil asimétrico redondeado de paso fino	W	Fresa para materiales no féreos (suaves y maleables)		
NF	Rompevirutas con perfil plano de paso grande	W NRA	Para materiales no ferreos con rompevirutas con perfil asimétrico redondeado de paso grande		

Número de canales (NOF)

NOF 1	Número de canales = 1 (un solo diente)	NOF 3-6	Número de canales = 3 – 6 (dientes)	NOF 6-12	Número de canales = 6 – 12 (dientes)
NOF 2	Número de canales = 2 (dientes)	NOF 4	Número de canales = 4 (dientes)	NOF 6-8	Número de canales = 6 – 8 (dientes)
NOF 3	Número de canales = 3 (dientes)	NOF 4≠	Número de canales = 4 (paso diferencial)	NOF 8	Número de canales = 8 (dientes)
NOF 3≠	Número de canales = 3 (paso diferencial)	NOF 4-5	Número de canales = 4 – 5 (dientes)	NOF 10-12	Número de canales = 10 – 12 (dientes)
NOF 3-4	Número de canales = 3 – 4 (dientes)	NOF 4-6	Número de canales = 4 – 6 (dientes)		
NOF 3-5	Número de canales = 3 – 5 (dientes)	NOF 5	Número de canales = 5 (dientes)		

Longitud de corte

	Longitud de corte, corta		Longitud de corte, larga		Longitud de corte, extralarga
	Longitud de corte, media		Longitud de corte, extracorta		

Ángulo de la hélice del canal (FHA)





λ 0°	Ángulo de hélice de 0° (canal recto)	λ 28°	Ángulo de la hélice de 28° (canal)	λ 40°	Ángulo de la hélice de 40° (canal)
λ 10°	Ángulo de la hélice de 10° (canal)	λ 30°	Ángulo de la hélice de 30° (canal)	λ 45°	Ángulo de la hélice de 45° (canal)
λ 15°	Ángulo de la hélice de 15° (canal)	λ 34°	Ángulo de la hélice de 34° (canal)	λ 50°	Ángulo de la hélice de 50° (canal)
λ 25°	Ángulo de la hélice de 25° (canal)	λ 35°	Ángulo de la hélice de 35° (canal)	λ ≠	Hélice desigual (variable)

RESUMEN DE SÍMBOLOS











Ángulo de incidencia radial (GAMF)

 -26°	Ángulo de incidencia radial de -26° (corte)	 5°	Ángulo de incidencia radial de 5° (corte)	 13°	Ángulo de incidencia radial de 13° (corte)
 -10°	Ángulo de incidencia radial de -10° (corte)	 7°	Ángulo de incidencia radial de 7° (corte)	 20°	Ángulo de incidencia radial de 20° (corte)
 -6°	Ángulo de incidencia radial de -6° (corte)	 8°	Ángulo de incidencia radial de 8° (corte)	 15°	Ángulo de incidencia radial de 15° (corte)
 0°	Ángulo de incidencia radial de 0° (corte)	 9°	Ángulo de incidencia radial de 9° (corte)	 18°	Ángulo de incidencia radial de 18° (corte)
 3°	Ángulo de incidencia radial de 3° (corte)	 10°	Ángulo de incidencia radial de 10° (corte)		
 4°	Ángulo de incidencia radial de 4° (corte)	 12°	Ángulo de incidencia radial de 12° (corte)		





Mango

 DIN 1835B	DIN 1835B mango Weldon	 DIN 6535HA	DIN 6535 HA mango cilíndrico	 DIN 1835A	DIN 1835A mango cilíndrico
 DIN 6535HB	DIN 6535 HB mango Weldon	 DIN 1835	DIN 1835-B mango (Weldon) o D (roscado)		

Clase de tolerancia del diámetro de corte (TCDC)

 DC d11	d11 – Tolerancia en base al diámetro	 DC h11	h11 – Tolerancia en base al diámetro	 DC k10	k10 – Tolerancia en base al diámetro
 DC e8	e8 – Tolerancia en base al diámetro	 DC h12	h12 – Tolerancia en base al diámetro	 DC k12	k12 – Tolerancia en base al diámetro
 DC h9	h9 – Tolerancia en base al diámetro	 DC js14	js14 – Tolerancia en base al diámetro		
 DC h10	h10 – Tolerancia en base al diámetro	 DC js16	js16 – Tolerancia en base al diámetro		

Dirección

 Radial, diagonal, axial	 Radial
 Radial, diagonal	 Radial

Refrigeración (CSP)

 Refrigeración interna



RESUMEN DE SÍMBOLOS

Grupo básico estándar (BSG)

	Normas Dormer		DIN 6527 K Normas para fresas integrales de metal duro		DIN 851 Normas para fresas de ranuras en «T»
	DIN 327 D Normas para brocas de ranurar		DIN 1880 Normas para portafresas		DIN 885 A Normas para fresas de planear y refrentar
	DIN 844 L Normas para fresas integrales de HSS		DIN 1837 Normas para sierras de corte fino		DIN 1833 C Normas para fresas tipo cola de milano
	DIN 844 K Normas para fresas integrales		DIN 1838 Normas para sierras de corte grueso		
	DIN 6527 L Normas para fresas de metal duro		DIN 850 Normas para fresas de chavetero		

Ángulo de aplicación

	Avellanador de 60°		Punta de la broca 135°		Punta de la broca de punteo 150°
	Avellanador de 90°		Punta de la broca 180°		

Punta de la Lima Rotativa

	Extremo de fresa integral		Extremo de corte frontal		Extremo de punta de broca
--	---------------------------	--	--------------------------	--	---------------------------

Forma de la Lima Rotativa

	Forma cilíndrica sin corte frontal		Forma de árbol con punta esférica		Forma de cono con punta esférica
	Forma cilíndrica con corte frontal		Forma de árbol con punta		Forma de cono
	Forma cilíndrica con punta esférica		Forma de llama		Forma de cono invertido
	Forma esférica		Forma de avellanador 60°		
	Forma ovalada		Forma de avellanador 90°		

Código de Tipo de Lima Rotativa (BTC)











	Geometría de corte para acero		Geometría de corte para aluminio		Geometría de corte para extracción de tornillos
	Geometría de corte para acero inoxidable		Geometría de corte para fibra de vidrio y materiales compuestos		
	Geometría de corte doble		Geometría de corte para superaleaciones		

RESUMEN DE SÍMBOLOS













Código de Material (BMC)

HSS	Acero rápido	HSS-E PM	Herramienta de acero rápido pulvimetalúrgico
HSS-E	Acero rápido al Cobalto	HM	Material duro

Recubrimiento

 Bright	Brillante (sin recubrimiento)	 TiSiN	Recubrimiento de nitruro de titanio y silicio	 AlTiN	Recubrimiento de nitruro de titanio y aluminio
 Hi	Acabado superficial pulido brillante	 TiCN	Recubrimiento de carbonitruro de titanio	 AlCrN	Recubrimiento de nitruro de aluminio y cromo
 ST	Tratamiento superficial templado al vapor (oxidación por vapor)	 TiAlN	Recubrimiento de nitruro de aluminio y titanio	 AlCrN	Recubrimiento de nitruro de aluminio y cromo
 X-CEED	Recubrimiento especial de AlTiN (con la máxima resistencia a la oxidación)	 Diamond	Recubrimiento diamantado		

Operaciones de desbarbado

 Desbarbado: operacion de retirada de tornillo 1	 Desbarbado y tallado de superficies curvas	 Desbarbado trasero invertido
 Desbarbado: operacion de retirada de tornillo 2	 Desbarbado de radios de filete	 Desbarbado de superficies planas
 Desbarbado y tallado de ranuras cerradas	 Desbarbado y tallado a mano alzada	 Desbarbado de escuadras
 Guiado de fibras compuestas	 Desbarbado de chaflanes	 Desbarbado de ranuras en «V»

Otros símbolos

	Tamaño de tornillo
--	--------------------

PARÁMETROS DE LA HERRAMIENTA DE CORTE DE ACUERDO CON LA NORMA ISO 13399

Todas las herramientas de corte se definen por una serie de parámetros según la norma ISO 13399. Esta lista contiene todos los parámetros utilizados en este catálogo junto con sus definiciones.

La ISO 13399 es una norma internacional relativa a las herramientas de corte. Proporciona dimensiones y parámetros en un formato neutral, que es independiente de cualquier sistema particular o nomenclatura de una empresa. Cuando las herramientas de corte están claramente definidas según una norma global, cualquier tipo de software puede procesar los datos electrónicos con mayor rapidez, lo que mejora la calidad de la comunicación y contribuye a que el intercambio de información sea fluido. La utilización de un lenguaje común en las descripciones de nuestras herramientas de corte facilitará la comunicación entre sistemas. Le ahorrará mucho tiempo, pues le facilitará la recopilación de datos de alta calidad de nuestras 40 000 herramientas de metal duro e intercambiables. Al utilizar un sistema compatible con la norma ISO 13399, no será necesario interpretar los datos e introducirlos en el sistema manualmente.

SOLO SON EJEMPLOS!

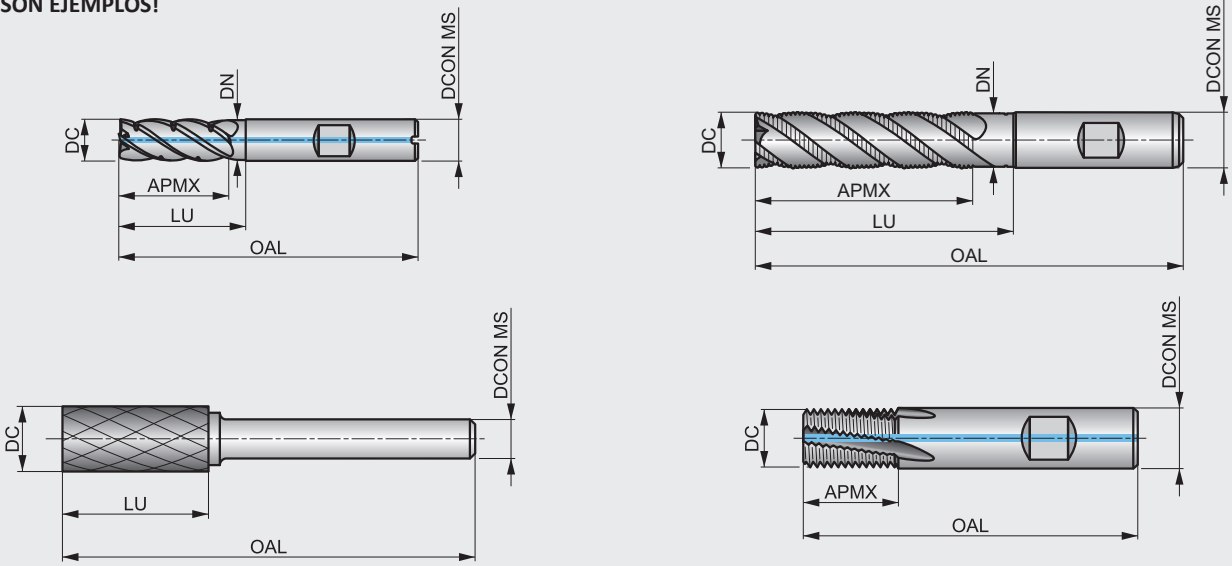





Código ISO 13399	Descripción
APMX	Profundidad de corte máxima
BD	Diámetro del cuerpo
BDX	Diámetro del cuerpo máximo
BCH	Longitud del chaflán de esquina
BS	Longitud del filo wiper
CBDP	Profundidad del agujero de conexión
CDI	Diámetro de corte de la plaquita
CDX	Profundidad de corte máxima
CW	Ancho de corte
CZC MS	Código de tamaño de conexión del lado de la máquina
D1	Diámetro del agujero de fijación
DAH4	Diámetro del agujero de acceso
DAH5	Diámetro del agujero de acceso
DAH6	Diámetro del agujero de acceso
DBC1	Diámetro de la circunferencia de pernos 1
DBC2	Diámetro de la circunferencia de pernos 2
DBC4	Diámetro de la circunferencia de pernos
DBC5	Diámetro de la circunferencia de pernos
DBC6	Diámetro de la circunferencia de pernos
DC	Diámetro de corte
DCB	Diámetro del agujero de conexión
DCCB	Diámetro de escariado del agujero de conexión

Código ISO 13399	Descripción
DCN	Diámetro de corte mínimo
DCON MS	Diámetro de conexión
DCX	Diámetro de corte máximo
DHUB	Diámetro de apoyo
DN	Diámetro del cuello
GAMF	Ángulo de incidencia radial
GAMP	Ángulo de desprendimiento axial
CHW	Ancho del chaflán de esquina
IC	Diámetro de la circunferencia inscrita
INSD	Diámetro de plaquita
INSL	Longitud de plaquita
KAPR	Ángulo del filo de corte de la herramienta
KWD	Profundidad del chavetero
KWW	Ancho del chavetero
L	Longitud del filo de corte
LB	Longitud del cuerpo
LE	Longitud efectiva del filo de corte
LF	Longitud funcional
LH	Longitud del cabezal
LU	Longitud útil
LUX	Longitud útil máxima
M	Dimensión M
NOF	Número de canales

Código ISO 13399	Descripción
OAL	Longitud total
P	Paso de la lama
PRFA	Ángulo de perfil
PRFRAD(2)	Radio de perfil
RE	Radio
S	Espesor de la plaquita de corte
S1	Espesor total de la plaquita de corte
TDZ	Tamaño del diámetro de rosca
TP	Paso de rosca
TPI	Hilos por pulgada
W1	Ancho de plaquita
ZNP	Número de filos periféricos en la herramienta

MATERIALES Y RECUBRIMIENTOS

Materiales

Acero rápido		Se trata de un acero rápido de aleación media que presenta una buena maquinabilidad y un excelente rendimiento. El HSS presenta características de dureza, tenacidad y resistencia al desgaste que lo hacen atractivo en una amplia variedad de aplicaciones, por ejemplo en brocas y machos de roscar.
Acero rápido al cobalto		Este acero rápido contiene cobalto para aumentar la dureza en caliente. La composición del HSCo proporciona una buena combinación de tenacidad y dureza. Posee una buena maquinabilidad y una elevada resistencia al desgaste, lo que lo hace apropiado para brocas, machos de roscar, fresas y escariadores.
Acero rápido al cobalto sinterizado		El acero rápido al cobalto sinterizado (HSCo pulvimetalúrgico) es un sustrato producido mediante tecnología pulvimetalúrgica. Las herramientas que emplean sustratos producidos por este método presentan una tenacidad y moluturabilidad superiores.
Materiales de metal duro (o materiales duros)		Un sustrato pulvimetalúrgico sinterizado, formado por un compuesto de carburo metálico con metal aglutinante. La materia prima más importante es el carburo de tungsteno (WC). El carburo de tungsteno contribuye al endurecimiento del material. El carburo de tántalo (TaC), el carburo de titanio (TiC) y el carburo de niobio (NbC) complementan al WC y adaptan sus propiedades según se desee. Estos tres materiales se conocen como carburos cúbicos. El cobalto (Co) actúa como aglutinante y mantiene el material unido.

Tratamientos superficiales/ Recubrimientos superficiales

Brillante (sin recubrimiento)		El acabado brillante (superficie sin recubrimiento) mejora el flujo de virutas en materiales blandos o no féreos y mantiene afilados los filos de corte en los materiales abrasivos.
Tratamiento de templado al vapor		El templado al vapor proporciona una superficie de óxido azul fuertemente adherida que permite retener el aceite de corte y evitar que la viruta se suelde con la herramienta, lo cual contrarresta la formación de un filo de aportación. El templado al vapor puede aplicarse a cualquier herramienta brillante, pero es más eficaz en brocas y machos de roscar.
Acabado superficial pulido brillante		El acabado superficial pulido brillante mejora enormemente el flujo de virutas en materiales blandos o no féreos y gomosos. El pulido facilita la evacuación de virutas y evita que el material se acumule en los filos de corte y en los canales.
Recubrimiento de nitruro (TiCN)		El carbonitruro de titanio es un recubrimiento cerámico que se aplica mediante tecnología de recubrimiento de PVD. El TiCN es más duro que el TiN y tiene un menor coeficiente de fricción. Debido a su dureza y tenacidad – en combinación con una buena resistencia al desgaste— se utiliza principalmente en el campo del fresado para mejorar el rendimiento de las fresas.
Recubrimientos de nitruro (TiAlN, TiAlN-Top y X-CEED)		El nitruro de aluminio y titanio es un recubrimiento cerámico multicapa aplicado mediante la tecnología de recubrimiento PVD, que presenta una gran tenacidad y estabilidad a la oxidación. Estas propiedades lo convierten en ideal para alcanzar velocidades y avances más rápidos, al tiempo que mejora la vida útil de la herramienta. El TiAlN se utiliza en aplicaciones de taladrado, roscado con macho y fresado y es apropiado para el mecanizado sin refrigerante. El recubrimiento TiAlN-Top es el mismo que el TiAlN, pero con un proceso posterior al recubrimiento diseñado para suavizar las imperfecciones, mejorar el flujo de la viruta y reducir la formación de filos de aportación. El recubrimiento TiAlN de tipo X-CEED – también conocido como recubrimiento Futura-Nano – es un recubrimiento de nanocapas diseñado para aplicaciones de mayor dureza en caliente y de mayor tensión.
Recubrimiento de nitruro de titanio y aluminio (AlTiN)		El nitruro de titanio y aluminio (AlTiN) es una tecnología de recubrimiento de base amplia y nanocapa que supone una mejora de los recubrimientos convencionales de TiAlN y puede ofrecer una tenacidad superior, una alta dureza en caliente y resistencia a la oxidación.
Recubrimientos Alcrona (AlCrN, Alcrona, Alcrona-Top y Alcrona-Pro)		La familia Alcrona (AlCrN) engloba recubrimientos de nitruro de aluminio y cromo que se utilizan principalmente para fresas. Las dos propiedades únicas de estos recubrimientos son la alta dureza en caliente y la alta resistencia a la oxidación. Cuando se utilizan en herramientas para aplicaciones de mecanizado que implican fuertes tensiones mecánicas y térmicas, estas propiedades se traducen en una mayor resistencia al desgaste. Existen varios niveles o versiones especiales de estos recubrimientos, que son específicos para diversas herramientas y aplicaciones.
Recubrimiento de nitruro de titanio y silicio (TiSiN)		El TiSiN está diseñado para condiciones de corte extremas y para el mecanizado a alta velocidad de materiales duros. Este recubrimiento multicapa tiene una capa exterior de nanocompuesto con nanocristalitos de Si ₃ N ₄ en una matriz cristalina de TiN y está diseñado para proteger el filo de corte frente a la transferencia de calor, la oxidación y la abrasión. Los recubrimientos de TiSiN pueden funcionar bien en condiciones de lubricación mínima o nula.
Recubrimiento diamantado (DLC)		El recubrimiento diamantado – también conocido como carbono diamantado (DLC) – proporciona la máxima lubricidad cuando se utiliza en herramientas de metal duro y evita la formación de filos al mecanizar grafito o materiales blandos no féreos.

INFORMACIÓN TÉCNICA SOBRE FRESADO

Nomenclatura

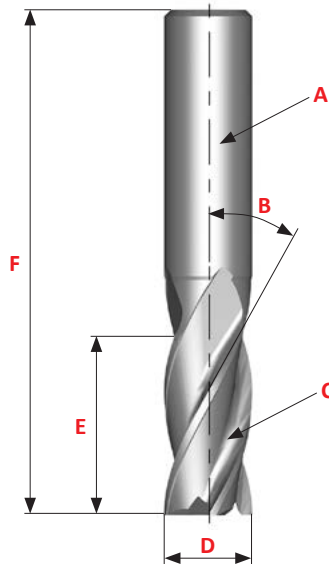

- A** Mango
- B** Ángulo de la hélice
- C** Canal
- D** Diámetro exterior *DC*
- E** Longitud de corte *AP*
- F** Longitud total *OAL*

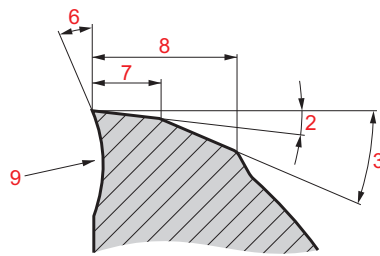
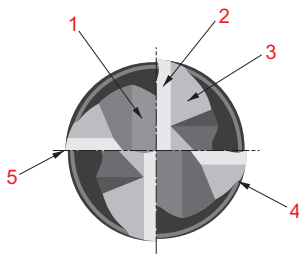

- 1** Entalladura
- 2** Ángulo de incidencia principal
- 3** Ángulo de incidencia secundaria
- 4** Talón
- 5** Filo de corte
- 6** Ángulo de desprendimiento
- 7** Ancho de la parte plana de incidencia principal
- 8** Ancho de la parte plana de incidencia secundaria
- 9** Cara de corte

Características de la fresa integral – elección del número de canales

El número de canales debe determinarse por:

- el material fresado;
- el tamaño de la pieza;
- las condiciones de fresado.

2 canales	3 canales	4 canales (o multicanal)
BAJA	FUERZA DE DESVIACIÓN	ALTA
GRANDE	ESPACIO DE VIRUTA	PEQUEÑO
<ul style="list-style-type: none"> • Gran espacio de viruta • Expulsión de la viruta sencilla • Se recomienda para ranurado • Se recomienda para fresado pesado • Menor rigidez debido a la pequeña superficie de la sección • Peor calidad del acabado superficial 	<ul style="list-style-type: none"> • Espacio de viruta casi del mismo tamaño que para 2 canales • Área de sección más grande: mayor rigidez que para 2 canales • Mejor acabado superficial 	<ul style="list-style-type: none"> • Máxima rigidez • Máxima área de sección: espacio de viruta pequeño • Ofrece el mejor acabado superficial posible • Se recomienda para perfilado, fresado lateral y ranurado hueco

INFORMACIÓN TÉCNICA SOBRE FRESADO

Características de la fresa integral: ángulo de la hélice

El aumento del número de canales hace que la carga sobre cada diente sea más homogénea y, en consecuencia, esto permite un mejor acabado. Pero con un ángulo de la hélice alto, la carga *FV* alrededor del eje de la fresa aumenta también.

Un *FV* elevado puede provocar:

- problemas de carga en los rodamientos del husillo;
- movimiento de la fresa a lo largo del eje del husillo. Para evitar este problema es necesario utilizar un portaherramientas mecánico o hidráulico tipo Weldon o mejor.



Consejos generales para fresar

El fresado es un proceso de mecanizado de superficies, que consiste en el eliminado progresivo de una determinada cantidad de material de la pieza de trabajo con un valor de avance relativamente bajo y con una alta velocidad de rotación. Las principales características del proceso de fresado es la eliminación de material de cada labio de la fresa, partiéndolo en pequeñas porciones (viruta).

Tipo de fresas

Las tres operaciones básicas de fresado se muestran a continuación: (A) fresado cilíndrico, (B) fresado frontal, (C) fresado de acabado.

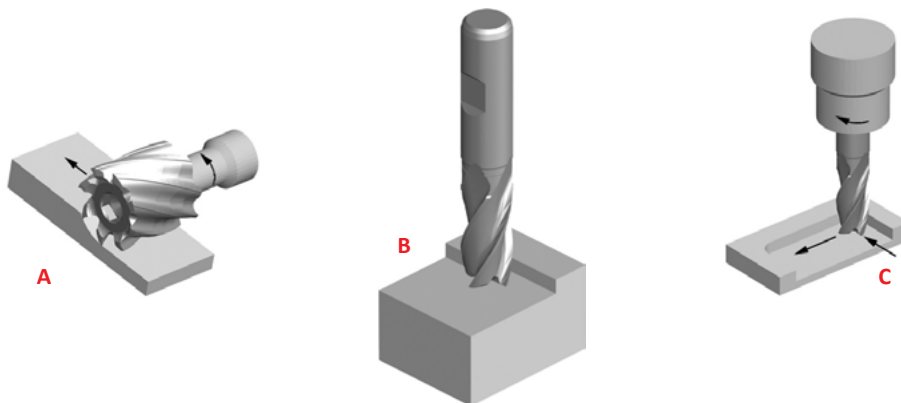

En el fresado cilíndrico el eje de rotación de las fresas es paralelo a la superficie de la pieza de trabajo a mecanizar. La fresa está rodeada de dientes a lo largo de su circunferencia, cada diente actúa como un punto de corte de la herramienta. Las fresas usadas para el fresado cilíndrico pueden tener estrías rectas o helicoidales, generando una sección de corte ortogonal u oblicua.





En el fresado frontal, la fresa se monta en el husillo de la máquina o en un portaherramientas, esta fresa tiene un eje de rotación perpendicular a la superficie de la pieza de trabajo. Las fresas frontales, tienen los filos de corte localizados en la periferia de la fresa y en la parte frontal.

En el fresado de acabado, las fresas generalmente rotan sobre un eje vertical a la pieza de trabajo. La fresa también puede estar inclinada respecto a la pieza de trabajo en caso que se quieran realizar superficies cónicas. Los dientes de corte están localizados en la periferia de la fresa y en la parte frontal.

INFORMACIÓN TÉCNICA SOBRE FRESADO

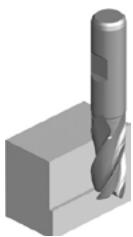
Aplicaciones

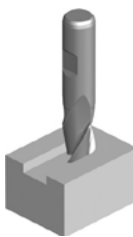
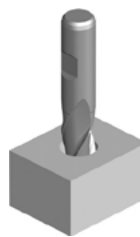
El Volumen de Viruta Arrancado (MRR) y las aplicaciones están estrechamente relacionadas. Por cada aplicación diferente, nosotros tenemos un valor distinto de Volumen de Viruta Arrancado (MRR) que aumenta con el aumento del área de contacto entre la herramienta y la pieza de trabajo. En el catálogo Dormer se muestran las distintas aplicaciones en distintos iconos.

Contorneado	Fresado Frontal	Ranurado	Fresado por penetración	Fresado en rampa
				
La profundidad radial de corte debe ser inferior a $0.25 \times$ diámetro de la fresa frontal.	La profundidad radial de corte debe ser inferior a $0.9 \times$ diámetro, la profundidad axial de corte debe ser inferior a $0.1 \times$ diámetro de las fresa frontal.	Para mecanizar ranuras para chavetas. La profundidad radial de corte ha de ser igual que el diámetro de la fresa frontal.	Es posible realizar un taladro en la pieza de trabajo solamente con las fresas frontales que tienen corte al centro, en estas aplicaciones el avance tiene que ser reducido.	Tanto la profundidad radial como la axial se realizan simultáneamente en la pieza de trabajo.

Fresado eficaz

Tipos de cortes

Fresado inverso o concurrente frente a fresado convencional

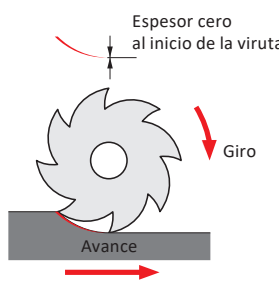
FRESADO INVERSO O CONCURRENTE	FRESADO CONVENCIONAL
 <p>Espesor máx. de la viruta formada</p> <p>Giro</p> <p>Avance</p>	 <p>Espesor cero al inicio de la viruta</p> <p>Giro</p> <p>Avance</p>

En el fresado inverso o concurrente, la fresa gira en la misma dirección que el avance de la mesa. El diente se encuentra con la pieza de trabajo en la parte superior del corte, por lo que produce primero la parte más gruesa de la viruta. En aplicaciones horizontales, la fuerza resultante creada por el fresado inverso puede actuar como fuerza de sujeción, que actúa en dirección a la mesa de la máquina. Es importante asegurarse de que la máquina-herramienta no tiene holgura en el husillo. Por lo general, el fresado inverso mejora el acabado superficial del producto y aumenta la vida útil de la herramienta.

En el fresado convencional, la fresa gira en la dirección opuesta a la de avance de la mesa. Por lo tanto, la anchura de la viruta comienza en cero y aumenta hasta un máximo al final del corte. Esto puede provocar un desgaste acelerado de la herramienta en determinadas condiciones. El fresado convencional puede ser ventajoso cuando se fresa acero laminado en caliente, endurecido en superficie y aceros con cascarilla superficial.

FRESADO PERIFÉRICO (CILÍNDRICO, BLOQUE)

Fresado periférico: fresado de una superficie paralela al eje de la fresa integral.

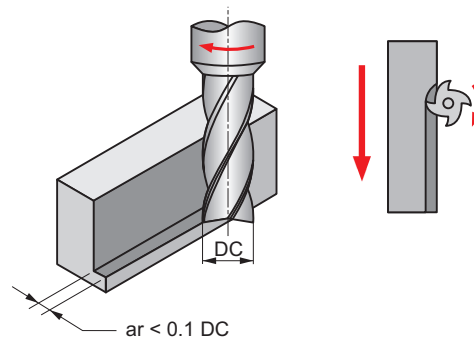

La profundidad de corte radial debe ser inferior a 0.1 del diámetro de la fresa: $ar < 0.1 DC$.



INFORMACIÓN TÉCNICA SOBRE FRESADO

Fresado axial

Movimiento directo entre la pieza y la línea central de la fresa integral cuando esta se hunde directamente en la pieza.

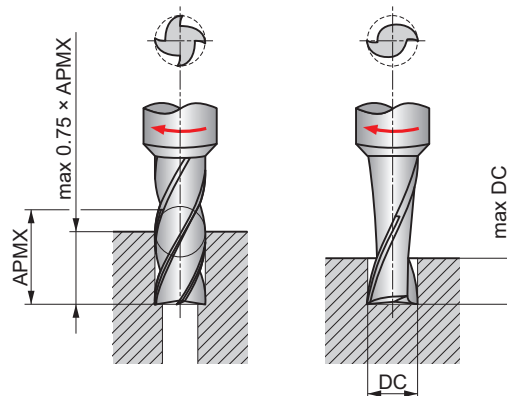

Para poder «taladrar», es decir, fresar con avance axial, una fresa integral debe tener un filo de corte de la cara final que llegue hasta el centro. Un ejemplo de este tipo de operación de taladrado macizo es el fresado de chavetas en el centro de un eje.

En el mandrinado, la profundidad de un agujero puede ser de hasta el 75 % de la longitud del filo de corte. Sin embargo, en el taladrado macizo no debe exceder 0.5 – 1.0 DC.

Ranurado

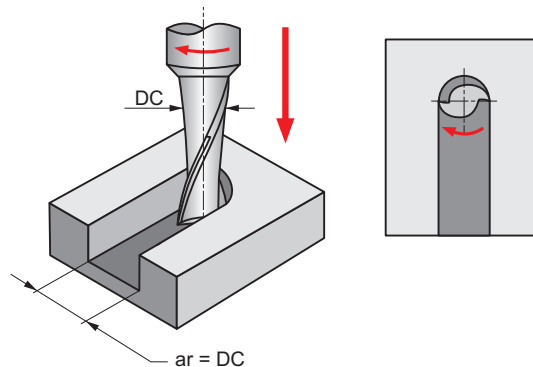

La profundidad de corte radial es igual al diámetro de la fresa: $ar = DC$.

Todas las aplicaciones de ranurado son una combinación de fresado convencional y fresado inverso o concurrente. Consulte la sección contigua.

Selección de la fresa integral

Utilice la herramienta más corta disponible para la aplicación con el mayor diámetro permitido y la menor longitud de canal que permita la profundidad de corte. Las fresas integrales extralargas tienen un voladizo excesivo, por lo que puede ser necesaria una reducción del avance de hasta un 25 %. Las fresas integrales de longitud corta, debido a su corta longitud total y de canal, tienen una mayor rigidez, por lo que puede ser necesario un aumento de las velocidades de avance de hasta el 25 %.

Velocidades

Las fresas integrales de metal duro deben funcionar a mayor velocidad que las de acero rápido. Muchas veces, los cortes más ligeros a mayor velocidad pueden mejorar el acabado de la pieza.

Cuando debe realizarse un corte de ranura, la velocidad debe reducirse aproximadamente un 20 %. Las velocidades se deben reducir al fresar materiales duros o difíciles de mecanizar, o al realizar cortes complejos. Las velocidades se deben aumentar al fresar materiales blandos o al realizar cortes ligeros. También hay que aumentar la velocidad para los cortes de acabado.

Refrigerantes

El uso de refrigerantes se recomienda al fresar acero dulce y aleaciones de alta temperatura. El cometido del medio refrigerante es dirigir las virutas lejos de la herramienta de corte y la pieza. Esto evita que se produzcan daños en los filos de corte debido al recortado de las virutas. En el mecanizado de titanio, el flujo de refrigerante debe ser intenso y dirigirse a la zona de corte para evitar el sobrecalentamiento y ayudar a la eliminación de la viruta.

FRESAS INTEGRALES DE HSS – TABLA DE AVANCE POR DIENTE

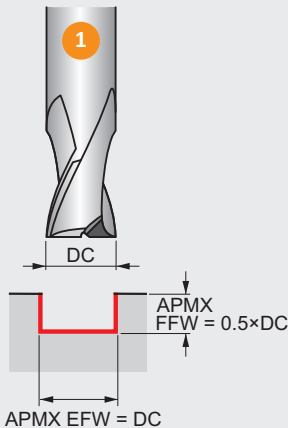

1

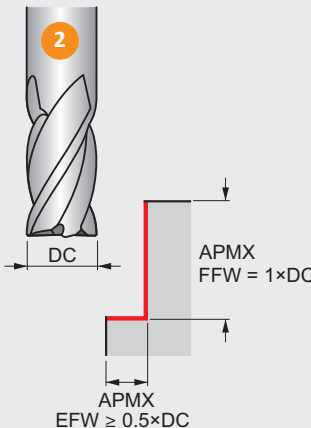

2

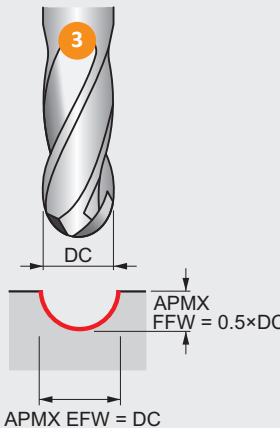

3

Avance por diente f_z (mm/diente) dependiendo de las condiciones de trabajo; puede que sea necesario ajustar estos valores $\pm 25\%$.

SOLO se deben considerar los valores en esta tabla como f_n (avance por revolución) si se realiza un fresado de penetración (plunging) en el material con una fresa integral con corte al centro.

Cómo utilizar esta tabla para encontrar el valor de avance por diente f_z :

1. Localice su código alfabético en la página del producto (ejemplo: 48C, «C» es el código alfabético).
2. Localice en la fila superior de la tabla el diámetro más adecuado para su aplicación de corte.
3. Localice su código alfabético en la columna de la izquierda de la tabla.
4. La intersección (celda) del diámetro y el código alfabético es el avance por diente f_z .

**SOLO PARA
FRESAS HSS,
HSS-E Y
HSS-E-PM**

		\varnothing DC (mm)																		
		1.00	2.00	3.00	4.00	5.00	6.00	8.00	10.0	12.0	16.0	20.0	25.0	28.0	32.0	36.0	40.0	63.0	80.0	100.0
Avances (mm/diente)	A	0.002	0.003	0.003	0.005	0.005	0.005	0.007	0.009	0.011	0.015	0.018	0.023	0.027	0.030	0.033	0.034	0.043	0.045	0.042
	B	0.003	0.004	0.004	0.006	0.006	0.007	0.009	0.012	0.014	0.018	0.023	0.029	0.033	0.038	0.041	0.043	0.054	0.057	0.052
	C	0.004	0.004	0.005	0.007	0.008	0.008	0.011	0.015	0.017	0.023	0.029	0.036	0.042	0.047	0.051	0.054	0.067	0.071	0.065
	D	0.005	0.006	0.006	0.009	0.010	0.010	0.014	0.018	0.022	0.029	0.036	0.045	0.052	0.059	0.064	0.067	0.084	0.089	0.082
	E	0.006	0.007	0.008	0.011	0.012	0.013	0.017	0.023	0.027	0.036	0.045	0.056	0.065	0.074	0.080	0.084	0.105	0.111	0.102
	F	0.007	0.008	0.010	0.013	0.014	0.016	0.020	0.028	0.032	0.043	0.054	0.067	0.078	0.089	0.096	0.101	0.126	0.133	0.122
	G	0.009	0.010	0.012	0.016	0.017	0.019	0.024	0.033	0.039	0.052	0.065	0.081	0.094	0.107	0.115	0.121	0.151	0.160	0.147
	H	0.010	0.012	0.014	0.019	0.021	0.022	0.029	0.040	0.047	0.062	0.078	0.097	0.112	0.128	0.138	0.145	0.181	0.192	0.176
	I	0.012	0.015	0.017	0.023	0.025	0.027	0.035	0.048	0.056	0.075	0.093	0.116	0.135	0.153	0.166	0.174	0.218	0.230	0.212
	J	0.015	0.017	0.020	0.027	0.030	0.032	0.042	0.057	0.067	0.090	0.112	0.139	0.162	0.184	0.199	0.209	0.261	0.276	0.254

Esta tabla es válida para fresas integrales y fresas huecas.

Fórmulas (sistema métrico)		Términos		Fórmulas (sistema imperial)	
$v_c = \frac{n \times DC \times \pi}{1000}$	v_c	(m/min)	Velocidad de corte	SFM	(pies/min)
	$n = \frac{v_c \times 1000}{DC \times \pi}$	n	(rev/min)	Velocidad del husillo	RPM
$V_f = f_z \times z \times n$	V_f	(mm/min)	Velocidad de avance	IPM	(pulgadas/min)
	$f_z = \frac{V_f}{z \times n}$	f_z	(mm/diente)	Avance por diente	IPT
$Q = \frac{V_f \times a_p \times a_e}{1000}$	DC	(mm)	Diámetro de corte	DC	(in)
	z	(-)	Número de dientes	T	(-)
	a_p	(mm)	Profundidad de corte	DOC	(in)
	a_e	(mm)	Ancho de corte	WOC	(in)
	Q	(cm ³ /min)	Tasa de eliminación de metal	MRR	(pulg. ³ /min)

$$SFM = \frac{RPM \times DC \times \pi}{12}$$

$$RPM = \frac{SFM \times 12}{DC \times \pi}$$

$$IPM = IPT \times T \times RPM$$

$$IPT = \frac{IPM}{T \times RPM}$$

$$MRR = IPM \times DOC \times WOC$$

FRESAS INTEGRALES DE HSS – TABLA DE AVANCE POR DIENTE

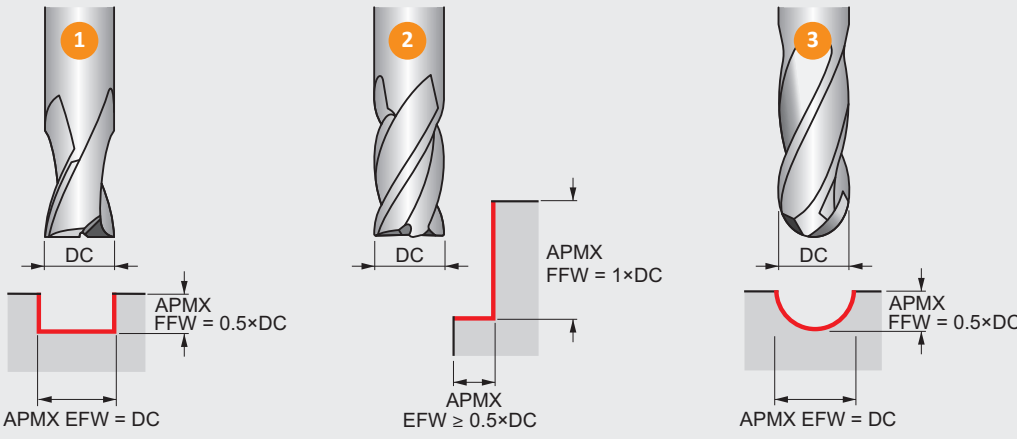

Avance por diente *IPT* (pulgada/diente): dependiendo de las condiciones de trabajo puede ser necesario ajustar estos valores $\pm 25\%$.
 SOLO al penetrar materiales de metal duro con una fresa integral de corte central se pueden considerar los valores de esta tabla como *IPR* (avance en pulgadas por revolución).

Cómo utilizar esta tabla para encontrar el valor de avance por diente *IPT*:

1. Localice su código alfabético en la página del producto (ejemplo: 157C, «C» es el código alfabético).
2. Localice en la fila superior de la tabla el diámetro más adecuado para su aplicación de corte.
3. Localice su código alfabético en la columna de la izquierda de la tabla.
4. La intersección (celda) del diámetro y el código alfabético es el avance por diente *IPT*.

**SOLO PARA
FRESAS HSS,
HSS-EY
HSS-E-PM**



		Ø DC (pulgadas)																		
		1/16	3/32	1/8	5/32	3/16	7/32	1/4	5/16	3/8	7/16	1/2	9/16	5/8	3/4	7/8	1	1 1/8	1 1/4	1 1/2
		.0625	.0938	.1250	.1563	.1875	.2188	.2500	.3125	.3750	.4375	.5000	.5625	.6250	.7500	.8750	1.0000	1.1250	1.2500	1.5000
Avances (pulgada/diente)	A	.0001	.0001	.0001	.0002	.0002	.0002	.0002	.0003	.0004	.0004	.0005	.0006	.0006	.0007	.0008	.0009	.0011	.0012	.0013
	B	.0001	.0002	.0002	.0002	.0002	.0002	.0003	.0004	.0004	.0005	.0006	.0007	.0007	.0009	.0011	.0012	.0014	.0015	.0017
	C	.0002	.0002	.0002	.0003	.0003	.0003	.0004	.0004	.0005	.0006	.0007	.0008	.0009	.0011	.0013	.0015	.0017	.0019	.0020
	D	.0002	.0002	.0002	.0004	.0004	.0004	.0004	.0006	.0007	.0008	.0009	.0010	.0011	.0013	.0017	.0019	.0021	.0023	.0026
	E	.0002	.0003	.0003	.0004	.0005	.0005	.0006	.0007	.0008	.0010	.0011	.0013	.0014	.0017	.0020	.0023	.0027	.0029	.0032
	F	.0003	.0003	.0004	.0005	.0006	.0006	.0007	.0008	.0010	.0012	.0014	.0016	.0017	.0020	.0024	.0028	.0032	.0035	.0039
	G	.0004	.0004	.0005	.0006	.0007	.0007	.0008	.0009	.0012	.0014	.0017	.0019	.0020	.0024	.0030	.0033	.0039	.0042	.0046
	H	.0004	.0005	.0006	.0007	.0008	.0008	.0009	.0011	.0014	.0017	.0020	.0022	.0024	.0029	.0035	.0040	.0046	.0050	.0056
	I	.0005	.0006	.0007	.0009	.0010	.0010	.0011	.0014	.0017	.0020	.0024	.0027	.0030	.0035	.0043	.0048	.0056	.0060	.0067
	J	.0006	.0007	.0008	.0011	.0012	.0012	.0014	.0017	.0020	.0024	.0028	.0032	.0035	.0042	.0051	.0058	.0067	.0072	.0080

Esta tabla es válida para fresas integrales y fresas huecas.

FRESAS INTEGRALES DE HSS – FACTORES DE CORRECCIÓN



1 Ranurado

Factores de corrección para la velocidad de corte v_c y el avance por diente f_z para operaciones de ranurado a diferentes profundidades de corte.

APMX FFW / DC	25 %	50 %	100 %	150 %
	1.25	1.00	0.75	0.50
	1.25	1.00	0.75	0.50

2 Escuadrado

Factores de corrección para la velocidad de corte v_c y el avance por diente f_z para escuadrado cuadrado con < 50 % de inmersión radial.

APMX EFW / DC	5 %	10 %	15 %	20 %	25 %	30 %	40 %	≥ 50 %
	1.48	1.35	1.27	1.22	1.19	1.16	1.11	1.00
	2.29	1.67	1.40	1.25	1.15	1.09	1.02	1.00

Recomendamos evitar el fresado con un 50 % de inmersión radial.

3a Fresado en copia plano (con fresas de punta esférica)

Factores de corrección para la velocidad de corte v_c para el fresado en copia plano a diferentes profundidades de corte.

APMX FFW / DC	5 %	10 %	15 %	20 %	25 %	30 %	40 %	50 %
	2.29	1.67	1.40	1.25	1.15	1.09	1.02	1.00

3b

Desplazamiento de línea f_e (distancia de paso) para lograr una rugosidad superficial teórica R_{th} .

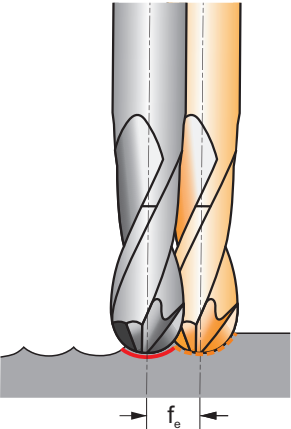
DC	μm	2	4	8	16	32	63	125	250
2		0.13	0.18	0.25	0.36	0.50	0.70	0.97	1.32
3		0.15	0.22	0.31	0.44	0.62	0.86	1.20	1.66
4		0.18	0.25	0.36	0.50	0.71	1.00	1.39	1.94
5		0.20	0.28	0.40	0.56	0.80	1.12	1.56	2.18
6		0.22	0.31	0.44	0.62	0.87	1.22	1.71	2.40
8		0.25	0.36	0.51	0.71	1.01	1.41	1.98	2.78
10		0.28	0.40	0.57	0.80	1.13	1.58	2.22	3.12
12		0.31	0.44	0.62	0.88	1.24	1.73	2.44	3.43
14		0.33	0.47	0.67	0.95	1.34	1.87	2.63	3.71
16		0.36	0.51	0.72	1.01	1.43	2.00	2.82	3.97
18		0.38	0.54	0.76	1.07	1.52	2.13	2.99	4.21
20		0.40	0.57	0.80	1.13	1.60	2.24	3.15	4.44
22		0.42	0.59	0.84	1.19	1.68	2.35	3.31	4.66
25	0.45	0.63	0.89	1.26	1.79	2.51	3.53	4.97	
28	0.47	0.67	0.95	1.34	1.89	2.65	3.73	5.27	

Las dimensiones del desplazamiento de línea que se muestran se expresan únicamente en unidades del sistema métrico (mm).

FRESAS INTEGRALES DE HSS – FACTORES DE CORRECCIÓN

3c

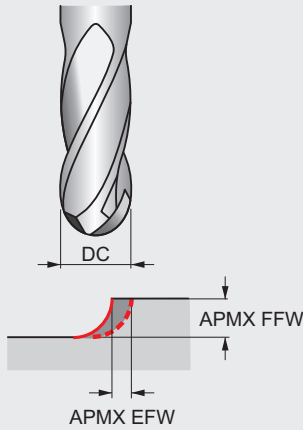

Cómo utilizar esta tabla para encontrar el factor de corrección para el avance por diente (f_z o IPT) para fresado en copia plano:

1. Localice en la fila superior de la tabla la inmersión radial más adecuada (a_e / DC) para su aplicación de corte.
3. Localice en la columna izquierda de la tabla la inmersión axial más adecuada (a_p / DC) para su aplicación de corte.
4. La intersección (célula) de las inmersiones radial y axial es el factor de corrección del avance por diente.

Ejemplo de fresado en copia plano:

1. Si se utiliza una fresa de punta esférica de 8 mm con una profundidad de corte de 0.8 mm (a_p), el objetivo es lograr una rugosidad superficial teórica de $32 \mu\text{m}$.
2. El factor de corrección de la velocidad de corte con una inmersión axial del 10% = 1.67 se puede consultar en la tabla 3a.
3. La distancia de paso para $a_{R_{th}}$ de $32 \mu\text{m}$ = 1.01 mm se puede consultar en la tabla 3b.
4. El factor de corrección para el avance por diente con una inmersión axial del 10% y una inmersión radial de $1.01 / 8 = 12.6\%$ se puede consultar en la tabla 3c y, en este caso, es de 2.33.

Factores de corrección para el avance por diente f_z en el caso del fresado en copia plano con un desplazamiento de línea $< 50\% \times DC$ a diferentes profundidades de corte.

APMX FFW	APMX EFW	5%	10%	15%	20%	25%	30%	35%	40%	50%
5%	$\times f$ 	5.26	3.82	3.21	2.87	2.65	2.50	2.40	2.34	2.29
10%		3.82	2.78	2.33	2.08	1.92	1.82	1.75	1.70	1.67
15%		3.21	2.33	1.96	1.75	1.62	1.53	1.47	1.43	1.40
20%		2.87	2.08	1.75	1.56	1.44	1.36	1.31	1.28	1.25
25%		2.65	1.92	1.62	1.44	1.33	1.26	1.21	1.18	1.15
30%		2.50	1.82	1.53	1.36	1.26	1.19	1.14	1.11	1.09
35%		2.40	1.75	1.47	1.31	1.21	1.14	1.10	1.07	1.05
40%		2.34	1.70	1.43	1.28	1.18	1.11	1.07	1.04	1.02
45%		2.31	1.68	1.41	1.26	1.16	1.10	1.05	1.03	1.01
50%		2.29	1.67	1.40	1.25	1.15	1.09	1.05	1.02	1.00

Para mejorar la calidad superficial, la herramienta o superficie debe inclinarse con un ángulo de inclinación de $10^\circ - 15^\circ$.

FRESAS INTEGRALES DE HSS – TABLA DE AVANCE POR DIENTE

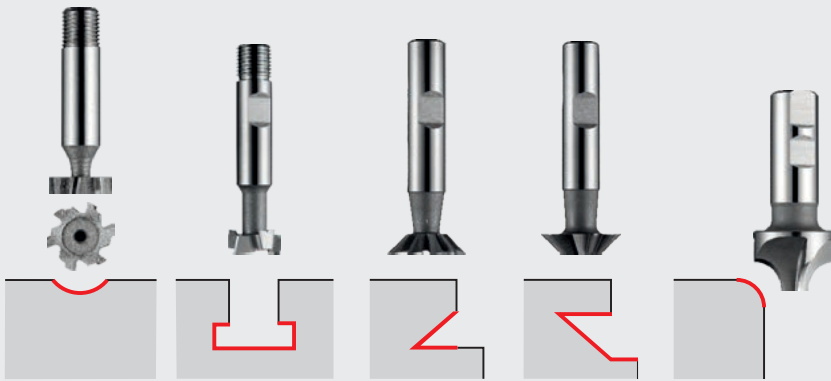

Avance por diente f_z (mm).
Dependiendo de las condiciones de trabajo puede ser necesario ajustar estos valores $\pm 25\%$.

Cómo utilizar esta tabla para encontrar el valor de avance por diente f_z :

1. Localice su código alfabético en la página del producto (ejemplo: 40V, «V» es el código alfabético).
2. Localice en la fila superior de la tabla el diámetro más adecuado para su aplicación de corte.
3. Localice su código alfabético en la columna de la izquierda de la tabla.
4. La intersección (celda) del diámetro y el código alfabético es el avance por diente f_z .

Avances para fresas: C800, C801, C810, C820, C822, C825, C830, C835, C837, C831, C700, C710, D745, D747, D750, D751, D752, D753, D200, D763.

		ø DC (mm)															
		10.0	12.0	16.0	20.0	25.0	32.0	38.0	50.0	63.0	80.0	100.0	125.0	160.0	200.0	300.0	350.0
Avances (mm)	P	–	–	–	–	–	0.200	–	0.200	0.200	0.200	0.200	0.200	0.200	0.200	0.200	0.200
	Q	–	–	–	–	–	0.040	–	0.040	0.040	0.040	0.040	0.040	0.040	0.040	0.040	0.040
	R	–	–	–	–	–	0.600	–	0.600	0.600	0.600	0.600	0.600	0.600	0.600	0.600	0.600
	S	0.020	0.020	0.020	0.040	0.040	0.040	0.040	0.050	0.050	0.060	0.070	0.080	0.090	0.100	0.100	0.100
	T	0.020	0.020	0.030	0.050	0.050	0.050	0.060	0.060	0.060	–	–	–	–	–	–	–
	U	0.030	0.030	0.030	0.050	0.060	0.060	0.060	0.060	0.060	–	–	–	–	–	–	–
	V	0.030	0.030	0.040	0.060	0.060	0.060	0.070	0.070	0.070	0.080	0.090	0.100	0.110	0.120	0.120	0.120
	W	0.040	0.050	0.050	0.060	0.060	0.070	0.070	0.070	0.070	0.090	0.100	0.110	0.110	0.120	0.120	0.120
	X	0.050	0.050	0.060	0.070	0.080	0.100	0.110	0.110	0.110	0.110	0.110	0.120	0.130	0.140	0.140	0.140
	Y	0.060	0.060	0.070	0.090	0.100	0.110	0.130	0.130	–	–	–	–	–	–	–	–
Z	0.070	0.070	0.090	0.110	0.120	0.110	0.150	–	–	–	–	–	–	–	–	–	

Los valores de avance f_z que se muestran se expresan únicamente en unidades del sistema métrico (mm).

SIERRAS DE CORTE DE HSS – TABLAS DE ELECCIÓN DE PASO POR DIENTE

Opciones de paso de los dientes para las sierras de corte D750, D751, D752, D753

		Sección de metal duro							
		Paso de sierra (P)							
		2.5	3	4	5	6	8		
Diámetro (t)	4		P	M	N	K			
	6			P	M	N	K		
	8				P	M	N	K	
	10				P	M	N	K	
	15					P	M	N	K
	20					P	M	N	K
	30							P	M
	40								P
60									

P ISO P = grupo de material de la pieza de acero
M ISO M = grupo de material de la pieza de acero inoxidable

		Perfiles y tubos							
		Paso de sierra (P)							
		2.5	3	4	5	6	8		
Espesor de pared (t)	1		P	M	N	K			
	1.5			P	M	N	K		
	2				P	M	N	K	
	3					P	M	N	K
	> 4					P	M	N	K
	> 4						P	M	N

K ISO K = grupo de material de la pieza de fundición
N ISO N = grupo de material de la pieza no férreo

FRESAS DE METAL DURO INTEGRAL – TABLA DE AVANCES POR DIENTE

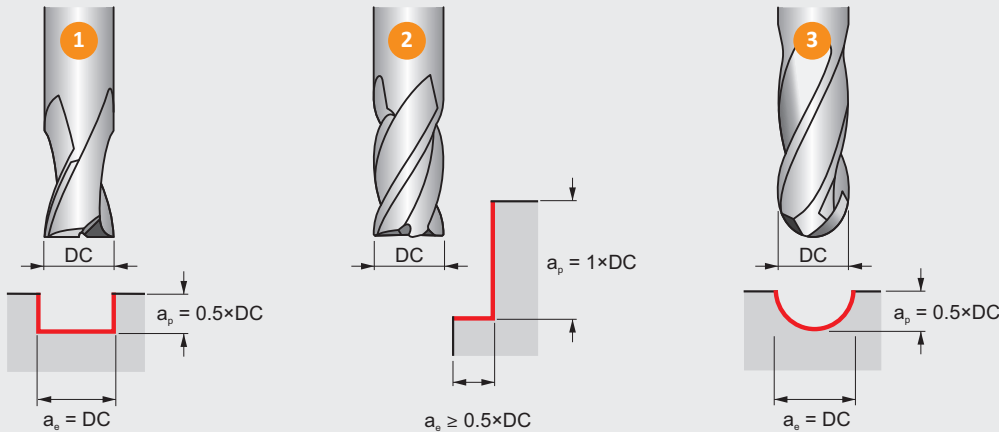

Avance por diente f_z (mm) dependiendo de las condiciones de trabajo; puede que sea necesario ajustar estos valores $\pm 25\%$.
 SOLO al penetrar materiales de metal duro con una fresa integral de corte central se pueden considerar los valores de esta tabla como f_n (avance por revolución).

Cómo utilizar esta tabla para encontrar el valor de avance por diente f_z :

1. Localice su código alfabético en la página del producto (ejemplo: 199K, «K» es el código alfabético).
2. Localice en la fila superior de la tabla el diámetro más adecuado para su aplicación de corte.
3. Localice su código alfabético en la columna de la izquierda de la tabla.
4. La intersección (celda) del diámetro y el código alfabético es el avance por diente f_z .

SOLO PARA FRESAS DE METAL DURO

		$\varnothing DC$ (mm)																
		1.00	2.00	3.00	4.00	5.00	6.00	7.00	8.00	9.00	10.0	12.0	14.0	16.0	18.0	20.0	22.0	25.0
Avances (mm)	A	0.002	0.003	0.004	0.005	0.006	0.007	0.008	0.009	0.010	0.011	0.014	0.015	0.017	0.019	0.021	0.025	0.028
	B	0.002	0.003	0.004	0.005	0.006	0.007	0.008	0.009	0.010	0.011	0.014	0.015	0.017	0.019	0.021	0.025	0.028
	C	0.002	0.003	0.004	0.005	0.006	0.007	0.008	0.009	0.010	0.011	0.014	0.015	0.017	0.019	0.021	0.025	0.028
	D	0.002	0.003	0.004	0.005	0.007	0.008	0.009	0.010	0.011	0.012	0.014	0.015	0.017	0.019	0.021	0.025	0.028
	E	0.002	0.003	0.004	0.008	0.009	0.012	0.013	0.014	0.015	0.016	0.019	0.021	0.024	0.026	0.028	0.030	0.034
	F	0.002	0.003	0.006	0.010	0.013	0.016	0.017	0.019	0.021	0.022	0.026	0.029	0.032	0.035	0.039	0.042	0.047
	G	0.002	0.005	0.008	0.014	0.018	0.022	0.024	0.026	0.028	0.031	0.035	0.040	0.044	0.048	0.053	0.057	0.064
	I	0.003	0.006	0.011	0.019	0.024	0.030	0.032	0.036	0.039	0.042	0.049	0.054	0.061	0.066	0.073	0.079	0.088
	J	0.004	0.009	0.014	0.026	0.033	0.041	0.044	0.048	0.053	0.057	0.066	0.074	0.083	0.090	0.099	0.107	0.120
	K	0.006	0.012	0.019	0.035	0.044	0.054	0.059	0.064	0.070	0.076	0.088	0.098	0.110	0.120	0.132	0.142	0.160
	N	0.008	0.016	0.025	0.047	0.058	0.072	0.078	0.086	0.094	0.101	0.117	0.131	0.146	0.160	0.175	0.189	0.212
	O	0.010	0.021	0.034	0.062	0.078	0.096	0.104	0.114	0.124	0.135	0.156	0.174	0.195	0.213	0.233	0.252	0.283
	P	0.014	0.028	0.045	0.083	0.104	0.128	0.138	0.152	0.166	0.180	0.207	0.231	0.259	0.283	0.311	0.335	0.376
	R	0.018	0.037	0.060	0.110	0.138	0.170	0.184	0.202	0.221	0.239	0.276	0.308	0.345	0.377	0.414	0.446	0.501
	S	0.024	0.049	0.080	0.147	0.183	0.226	0.245	0.269	0.294	0.318	0.367	0.410	0.459	0.502	0.550	0.593	0.667

Fórmulas (sistema métrico)		Términos		Fórmulas (sistema imperial)	
$v_c = \frac{n \times DC \times \pi}{1000}$	v_c	(m/min)	Velocidad de corte	SFM	(pies/min)
	n	(rev/min)	Velocidad del husillo	RPM	(rev/min)
$n = \frac{v_c \times 1000}{DC \times \pi}$	V_f	(mm/min)	Velocidad de avance	IPM	(pulgadas/min)
	f_z	(mm/diente)	Avance por diente	IPT	(in/diente)
$V_f = f_z \times z \times n$	DC	(mm)	Diámetro de corte	DC	(in)
$f_z = \frac{V_f}{z \times n}$	z	(-)	Número de dientes	T	(-)
$Q = \frac{V_f \times a_p \times a_e}{1000}$	a_p	(mm)	Profundidad de corte	DOC	(in)
	a_e	(mm)	Ancho de corte	WOC	(in)
	Q	(cm ³ /min)	Tasa de eliminación de metal	MRR	(pulg. ³ /min)
				$SFM = \frac{RPM \times DC \times \pi}{12}$ $RPM = \frac{SFM \times 12}{DC \times \pi}$ $IPM = IPT \times T \times RPM$ $IPT = \frac{IPM}{T \times RPM}$ $MRR = IPM \times DOC \times WOC$	

FRESAS DE METAL DURO INTEGRAL – TABLA DE AVANCES POR DIENTE

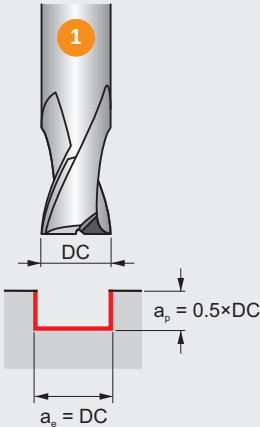

1

$a_p = 0.5 \times DC$

$a_e = DC$

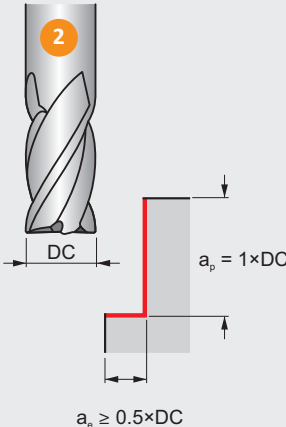

2

$a_p = 1 \times DC$

$a_e \geq 0.5 \times DC$

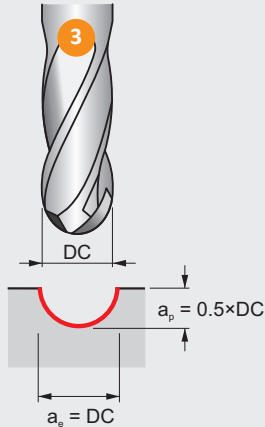

3

$a_p = 0.5 \times DC$

$a_e = DC$

Avance por diente *IP*T (pulgadas): dependiendo de las condiciones de trabajo puede ser necesario ajustar estos valores $\pm 25\%$.

SOLO al penetrar materiales de metal duro con una fresa integral de corte central se pueden considerar los valores de esta tabla como *IP*R (avance en pulgadas por revolución).

Cómo utilizar esta tabla para encontrar el valor de avance por diente *IP*T:

1. Localice su código alfabético en la página del producto (ejemplo: 653K, «K» es el código alfabético).
2. Localice en la fila superior de la tabla el diámetro más adecuado para su aplicación de corte.
3. Localice su código alfabético en la columna de la izquierda de la tabla.
4. La intersección (celda) del diámetro y el código alfabético es el avance por diente *IP*T.



**SOLO PARA
FRESAS DE
METAL DURO**

		$\varnothing DC$ (pulgadas)															
		1/16	3/32	1/8	5/32	3/16	7/32	1/4	5/16	3/8	7/16	1/2	9/16	5/8	3/4	7/8	1
		.0625	.0938	.1250	.1563	.1875	.2188	.2500	.3125	.3750	.4375	.5000	.5625	.6250	.7500	.8750	1.0000
Avances (pulgadas)	A	.0001	.0001	.0002	.0002	.0002	.0002	.0003	.0003	.0004	.0005	.0005	.0006	.0007	.0008	.0010	.0011
	B	.0001	.0001	.0002	.0002	.0002	.0002	.0003	.0003	.0004	.0005	.0005	.0006	.0007	.0008	.0010	.0011
	C	.0001	.0001	.0002	.0002	.0002	.0002	.0003	.0003	.0004	.0005	.0005	.0006	.0007	.0008	.0010	.0011
	D	.0001	.0001	.0002	.0002	.0002	.0003	.0004	.0004	.0004	.0005	.0006	.0006	.0007	.0008	.0010	.0011
	E	.0001	.0001	.0002	.0003	.0004	.0004	.0005	.0006	.0006	.0007	.0007	.0009	.0009	.0011	.0012	.0013
	F	.0001	.0002	.0002	.0004	.0005	.0006	.0006	.0007	.0009	.0009	.0011	.0012	.0013	.0015	.0017	.0019
	G	.0002	.0002	.0004	.0006	.0007	.0007	.0009	.0010	.0012	.0013	.0015	.0016	.0017	.0020	.0023	.0025
	I	.0002	.0003	.0005	.0007	.0009	.0011	.0012	.0014	.0016	.0018	.0020	.0022	.0024	.0028	.0031	.0035
	J	.0003	.0004	.0007	.0010	.0012	.0014	.0017	.0019	.0022	.0024	.0027	.0030	.0032	.0037	.0043	.0047
	K	.0004	.0006	.0009	.0014	.0016	.0019	.0022	.0025	.0029	.0032	.0036	.0040	.0043	.0050	.0056	.0063
	N	.0005	.0007	.0011	.0019	.0022	.0025	.0029	.0034	.0038	.0043	.0048	.0053	.0057	.0066	.0075	.0083
	O	.0006	.0010	.0015	.0024	.0029	.0034	.0039	.0045	.0051	.0057	.0063	.0070	.0076	.0088	.0100	.0111
	P	.0008	.0014	.0020	.0033	.0038	.0045	.0052	.0060	.0068	.0076	.0084	.0094	.0100	.0117	.0133	.0148
	R	.0011	.0018	.0027	.0043	.0051	.0060	.0069	.0080	.0091	.0101	.0112	.0125	.0134	.0156	.0177	.0197
	S	.0015	.0024	.0036	.0058	.0067	.0080	.0091	.0106	.0120	.0135	.0149	.0166	.0178	.0207	.0236	.0263

FRESAS DE METAL DURO INTEGRAL – FACTORES DE CORRECCIÓN



1 Ranurado

Factores de corrección para la velocidad de corte v_c y el avance por diente f_z para operaciones de ranurado a diferentes profundidades de corte.

a_p / DC	25 %	50 %	100 %	150 %
 X.V	1.25	1.00	0.75	0.50
 X.f	1.25	1.00	0.75	0.50

2 Escuadrado

Factores de corrección para la velocidad de corte v_c y el avance por diente f_z para escuadrado cuadrado con < 50 % de inmersión radial.

a_e / DC	5 %	10 %	15 %	20 %	25 %	30 %	40 %	≥ 50 %
 X.V	1.48	1.35	1.27	1.22	1.19	1.16	1.11	1.00
 X.f	2.29	1.67	1.40	1.25	1.15	1.09	1.02	1.00

Recomendamos evitar el fresado con un 50 % de inmersión radial.

3a Fresado en copia plano (con fresas de punta esférica)

Factores de corrección para la velocidad de corte v_c para el fresado en copia plano a diferentes profundidades de corte

a_p / DC	5 %	10 %	15 %	20 %	25 %	30 %	40 %	50 %
 X.V	2.29	1.67	1.40	1.25	1.15	1.09	1.02	1.00

3b

Desplazamiento de línea f_e (distancia de paso) para lograr una rugosidad superficial teórica R_{th}

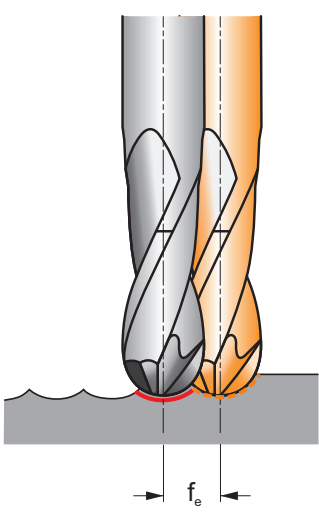
DC	μm	2	4	8	16	32	63	125	250
2		0.13	0.18	0.25	0.36	0.50	0.70	0.97	1.32
3		0.15	0.22	0.31	0.44	0.62	0.86	1.20	1.66
4		0.18	0.25	0.36	0.50	0.71	1.00	1.39	1.94
5		0.20	0.28	0.40	0.56	0.80	1.12	1.56	2.18
6		0.22	0.31	0.44	0.62	0.87	1.22	1.71	2.40
8		0.25	0.36	0.51	0.71	1.01	1.41	1.98	2.78
10		0.28	0.40	0.57	0.80	1.13	1.58	2.22	3.12
12		0.31	0.44	0.62	0.88	1.24	1.73	2.44	3.43
14		0.33	0.47	0.67	0.95	1.34	1.87	2.63	3.71
16		0.36	0.51	0.72	1.01	1.43	2.00	2.82	3.97
18		0.38	0.54	0.76	1.07	1.52	2.13	2.99	4.21
20		0.40	0.57	0.80	1.13	1.60	2.24	3.15	4.44
22		0.42	0.59	0.84	1.19	1.68	2.35	3.31	4.66
25		0.45	0.63	0.89	1.26	1.79	2.51	3.53	4.97
28	0.47	0.67	0.95	1.34	1.89	2.65	3.73	5.27	

Las dimensiones del desplazamiento de línea que se muestran se expresan únicamente en unidades del sistema métrico (mm).

FRESAS DE METAL DURO INTEGRAL – FACTORES DE CORRECCIÓN

3c

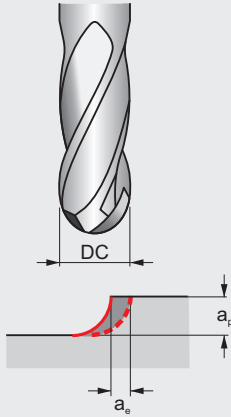

Cómo utilizar esta tabla para encontrar el factor de corrección para el avance por diente (f_z o IPT) para fresado en copia plano:

1. Localice en la fila superior de la tabla la inmersión radial más adecuada (a_e / DC) para su aplicación de corte.
3. Localice en la columna izquierda de la tabla la inmersión axial más adecuada (a_p / DC) para su aplicación de corte.
4. La intersección (célula) de las inmersiones radial y axial es el factor de corrección del avance por diente.

Ejemplo de fresado en copia plano:

1. Si se utiliza una fresa de punta esférica de 8 mm con una profundidad de corte de 0.8 mm (a_p), el objetivo es lograr una rugosidad superficial teórica de $32 \mu\text{m}$.
2. El factor de corrección de la velocidad de corte con una inmersión axial del 10% = 1.67 se puede consultar en la tabla 3a.
3. La distancia de paso para a R_{th} de $32 \mu\text{m}$ = 1.01 mm se puede consultar en la tabla 3b.
4. El factor de corrección para el avance por diente con una inmersión axial del 10% y una inmersión radial de $1.01 / 8 = 12.6\%$ se puede consultar en la tabla 3c y, en este caso, es de 2.33.

Factores de corrección para el avance por diente f_z en el caso del fresado en copia plano con un desplazamiento de línea $< 50\% \times DC$ a diferentes profundidades de corte.

APMX FFW	APMX EFW	5 %	10 %	15 %	20 %	25 %	30 %	35 %	40 %	50 %
5 %	$\times f_z$ 	5.26	3.82	3.21	2.87	2.65	2.50	2.40	2.34	2.29
10 %		3.82	2.78	2.33	2.08	1.92	1.82	1.75	1.70	1.67
15 %		3.21	2.33	1.96	1.75	1.62	1.53	1.47	1.43	1.40
20 %		2.87	2.08	1.75	1.56	1.44	1.36	1.31	1.28	1.25
25 %		2.65	1.92	1.62	1.44	1.33	1.26	1.21	1.18	1.15
30 %		2.50	1.82	1.53	1.36	1.26	1.19	1.14	1.11	1.09
35 %		2.40	1.75	1.47	1.31	1.21	1.14	1.10	1.07	1.05
40 %		2.34	1.70	1.43	1.28	1.18	1.11	1.07	1.04	1.02
45 %		2.31	1.68	1.41	1.26	1.16	1.10	1.05	1.03	1.01
50 %		2.29	1.67	1.40	1.25	1.15	1.09	1.05	1.02	1.00

Para mejorar la calidad superficial, la herramienta o superficie debe inclinarse con un ángulo de inclinación de $10^\circ - 15^\circ$.

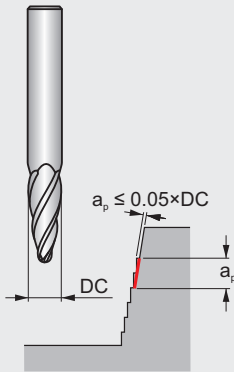
**FRESA INTEGRAL DE METAL DURO EN FORMA DE BARRIL – TABLA DE AVANCES POR DIENTE**

Avance por diente f_z (mm) dependiendo de las condiciones de trabajo; puede que sea necesario ajustar estos valores $\pm 25\%$.

Cómo utilizar esta tabla para encontrar el valor de avance por diente f_z :

1. Localice su código alfabético en la página del producto (ejemplo: 121F, «F» es el código alfabético).
2. Localice en la fila superior de la tabla el diámetro más adecuado para su aplicación de corte.
3. Localice su código alfabético en la columna de la izquierda de la tabla.
4. La intersección (celda) del diámetro y el código alfabético es el avance por diente f_z .

SOLO PARA FRESAS INTEGRALES DE METAL DURO EN FORMA DE BARRIL HM S791

		\varnothing DC (mm)				
		6.00	8.00	10.00	12.00	16.00
Avances (mm)	E	0.030	0.039	0.053	0.067	0.096
	F	0.037	0.050	0.064	0.083	0.118
	I	0.062	0.084	0.111	0.141	0.203



FRESAS DE ROSCAR – CONSEJOS GENERALES

INDICACIONES GENERALES SOBRE EL FRESADO DE ROSCAS

1. El fresado de roscas es el proceso por el cual se generan roscas mediante la interpolación circular de una fresa con una geometría de rosca específica conformada alrededor de su perímetro.
2. Para poder utilizar una fresa de roscar se necesita una máquina CNC capaz de realizar recorridos circulares.
3. Las máquinas CNC más modernas están equipadas con ciclos de mecanizado para el fresado de roscas.
4. Consulte el manual o póngase en contacto con el proveedor de la máquina para obtener más información.

Características y ventajas

1. El fresado de roscas proporciona una mayor fiabilidad y vida útil.
2. Las pequeñas virutas que producen las fresas de roscar son propias de un roscado normal.
3. Se pueden realizar ajustes de tolerancia utilizando coordenadas exactas.
4. Puede generar una rosca más completa en el fondo del orificio.
5. Capaz de mecanizar una gran variedad de materiales.
6. La misma fresa puede producir roscas de diferente tamaño siempre que el paso sea el mismo.
7. Se pueden crear tanto roscas a izquierda como a derecha con la misma herramienta.
8. Algunas fresas de roscar también pueden mecanizar el chaflán de entrada (J200 y J205).

ELECCIÓN DE LA HERRAMIENTA

Las fresas de roscar tienen un código de artículo basado en el tipo, el diámetro *DC* y el paso *TP*. El código de artículo es el número que deberá utilizar para encargar su herramienta. Consulte siempre el catálogo para asegurarse de que tiene las dimensiones de rosca correctas.

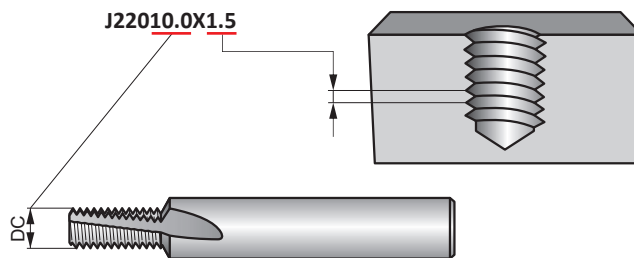

Esta fresa de roscar se puede utilizar para roscas \geq M12 \times 1,5 (M14 \times 1,5, M18 \times 1,5, etc.)

Programación con Rprg

- Para un ajuste sencillo de la tolerancia de la rosca, programe siempre con corrección de radio.
- El valor Rprg es el valor de inicio para una fresa nueva, y se encuentra impreso en el mango de la fresa. Este valor debe introducirse en el descentrado de la memoria de la herramienta.
- Rprg se basa en la línea cero teórica de la rosca, es decir, cuando realiza la programación con el Rprg, la rosca nunca está sobredimensionada, sino ajustada.
- Esto significa que, modificando ligeramente las coordenadas del programa, puede crear una rosca del tamaño requerido.

Recomendaciones

- Utilice siempre los datos de corte correctos (consulte la tabla de datos de corte en la sección «Producto»).
- Utilice el tamaño de broca recomendado para el diámetro de la rosca, como en el caso de los machos de roscar convencionales.
- Para un ajuste sencillo de la tolerancia de la rosca, comience siempre con el valor Rprg impreso en el mango de la fresa.
- Utilice un calibre para comprobar la tolerancia en la primera rosca y determinar si el radio requiere una corrección. El radio puede corregirse 2 o 3 veces antes de que la fresa de roscar se desgaste.
- Al realizar un mecanizado en seco, se recomienda utilizar aire comprimido para la eliminación de virutas.
- En el roscado de materiales más difíciles, se recomienda realizar múltiples pasadas.

FRESAS DE ROSCAR – TABLA DE AVANCE POR DIENTE

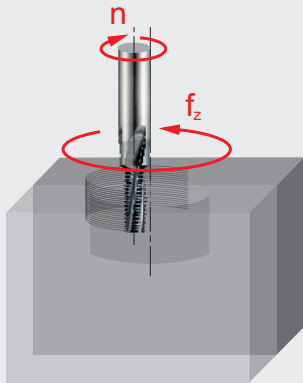

Cómo utilizar esta tabla para encontrar el valor de avance por diente f_z (mm):







1. Localice su código alfabético en la página del producto (ejemplo: 181B, «B» es el código alfa).
2. Seleccione la columna que coincida con el diámetro de su fresa en la fila superior de la tabla con el paso de rosca P o TPI (en las filas con iconos de la izquierda).
3. Localice su código alfabético en la columna de la izquierda de la tabla.
4. La intersección (celda) de la columna Diámetro + Paso y el código alfabético es el avance por diente f_z .

Corrección del avance por diente para las pasadas múltiples:

1. En el caso de que la rosca se mecanice en **2 pasadas**, los valores de avance indicados en la tabla aumentarán en un **30 – 40 %**.
2. En el caso de que la rosca se mecanice en **3 pasadas**, los valores de avance indicados en la tabla aumentarán en un **55 – 65 %**.
3. En el caso de que la rosca se mecanice en **4 pasadas**, los valores de avance indicados en la tabla aumentarán en un **80 – 90 %**.

(Ejemplo: J2003.2X.7 mecanizado WMG M4.1 con velocidad de avance A en 4 pasadas, $f_z = 0.017 \times 1.80 = 0.031$ mm/diente).

Los valores indicados son los valores iniciales recomendados para el mecanizado de toda la profundidad de la rosca en una sola pasada.

		Ø DC (mm)																											
		3.20	4.10	4.50	4.80	5.50	6.00	–	6.50	7.50	7.90	8.00	8.20	9.50	9.90	10.00	–	11.60	12.00	–	13.60	14.00	–	16.00	–	–	19.00	20.00	25.00
Avances (mm)		0.70	0.80	1.00	1.00	–	1.25	–	1.25	1.50	–	–	1.50	1.75	1.75	2.00	–	2.00	2.00	–	2.00	–	–	–	–	–	–	–	–
	A	0.017	0.022	0.023	0.024	–	0.024	–	0.029	0.036	–	–	0.040	0.044	0.047	0.053	–	0.056	0.068	–	0.071	–	–	–	–	–	–	–	–
	B	0.022	0.029	0.031	0.032	–	0.032	–	0.038	0.048	–	–	0.053	0.059	0.063	0.070	–	0.075	0.090	–	0.095	–	–	–	–	–	–	–	–
	C	0.028	0.036	0.039	0.040	–	0.040	–	0.048	0.060	–	–	0.066	0.074	0.079	0.088	–	0.094	0.113	–	0.119	–	–	–	–	–	–	–	–
		–	–	–	0.50	–	0.75	1.00	–	–	–	1.00	–	–	–	1.00	1.50	–	1.00	1.50	–	1.00	1.50	1.50	2.00	2.50	3.00	2.00	–
	D	–	–	–	0.044	–	0.041	0.036	–	–	–	0.057	–	–	–	0.075	0.067	–	0.079	0.071	–	0.083	0.071	0.092	0.081	0.073	0.067	0.096	–
	E	–	–	–	0.058	–	0.055	0.048	–	–	–	0.076	–	–	–	0.100	0.089	–	0.105	0.094	–	0.110	0.095	0.122	0.108	0.097	0.089	0.128	–
	F	–	–	–	0.073	–	0.069	0.060	–	–	–	0.095	–	–	–	0.125	0.111	–	0.131	0.118	–	0.138	0.119	0.153	0.135	0.121	0.111	0.160	–
		–	–	–	20	18	–	–	–	16	14	–	–	–	13	12	–	11	–	–	–	10	–	–	–	–	–	–	–
	G	–	–	–	0.019	0.023	–	–	–	0.030	–	0.034	–	–	–	0.053	0.051	–	0.055	–	–	0.066	–	–	–	–	–	–	–
	H	–	–	–	0.025	0.030	–	–	–	0.040	–	0.045	–	–	–	0.071	0.068	–	0.073	–	–	0.088	–	–	–	–	–	–	–
	I	–	–	–	0.031	0.038	–	–	–	0.050	–	0.056	–	–	–	0.089	0.085	–	0.091	–	–	0.110	–	–	–	–	–	–	–
		–	–	–	28	24	–	–	–	–	20	–	–	–	18	–	–	–	–	–	–	16	–	–	–	–	–	–	–
	J	–	–	–	0.023	–	0.026	–	–	–	–	0.041	–	–	–	0.062	–	–	–	–	–	0.083	–	–	–	–	–	–	–
	K	–	–	–	0.030	–	0.035	–	–	–	–	0.054	–	–	–	0.083	–	–	–	–	–	0.110	–	–	–	–	–	–	–
	L	–	–	–	0.038	–	0.044	–	–	–	–	0.068	–	–	–	0.104	–	–	–	–	–	0.138	–	–	–	–	–	–	–
		–	–	–	–	–	28	–	–	–	–	–	–	–	–	19	–	–	–	–	–	19	–	14	–	–	–	14	11
	M	–	–	–	–	–	0.029	–	–	–	–	–	–	–	–	0.064	–	–	–	–	–	0.080	–	0.083	–	–	–	0.116	0.131
	N	–	–	–	–	–	0.038	–	–	–	–	–	–	–	–	0.085	–	–	–	–	–	0.106	–	0.111	–	–	–	0.155	0.175
	O	–	–	–	–	–	0.048	–	–	–	–	–	–	–	–	0.106	–	–	–	–	–	0.133	–	0.139	–	–	–	0.194	0.219
		–	–	–	–	–	–	–	–	–	27	–	–	–	18	–	–	–	–	–	–	14	11.5	–	–	–	–	–	–
	Q	–	–	–	–	–	–	–	–	–	0.039	–	–	–	0.044	–	–	–	–	–	–	0.079	0.115	–	–	–	–	–	–
	R	–	–	–	–	–	–	–	–	–	0.052	–	–	–	0.059	–	–	–	–	–	–	0.105	0.153	–	–	–	–	–	–
	S	–	–	–	–	–	–	–	–	–	0.065	–	–	–	0.074	–	–	–	–	–	–	0.131	0.191	–	–	–	–	–	–

FRESAS DE ROSCAR – TABLA DE NÚMERO DE PASADAS

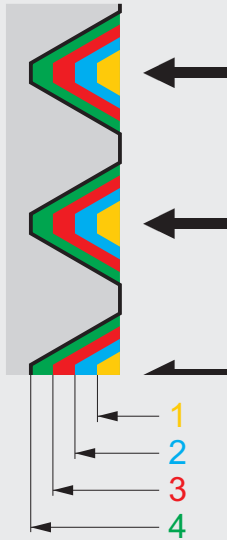

Cómo utilizar las tablas para encontrar los incrementos de profundidad por pasada:

1. Seleccione la tabla que corresponda a su perfil de rosca (ejemplo: «M12» es una rosca métrica).
2. Busque la columna que corresponda a su paso de rosca en la fila superior de la tabla.
3. Busque en esa columna de abajo el número de pasadas recomendado y para cada pasada, consulte el incremento de la profundidad de corte radial. (Ejemplo: para un paso de 1.75, el número de pasadas recomendado es de 5 y la profundidad radial de la 1.ª pasada es de 0.277 mm; la 2.ª, de 0.228 mm, etc.).
4. Se recomienda aumentar el número de pasadas para los materiales más difíciles de mecanizar.
5. Para obtener un resultado de acabado óptimo, se recomienda repetir la última pasada.

Número de pasadas y profundidad de corte radial por pasada recomendados para rosca métrica hembra (60°).

		Profundidad de corte radial por pasada (mm)										
		0.50	0.70	0.75	0.80	1.00	1.25	1.50	1.75	2.00	2.50	3.00
N.º de pasadas	1	0.158	0.221	0.168	0.224	0.224	0.228	0.237	0.277	0.283	0.323	0.387
	2	0.131	0.183	0.138	0.185	0.185	0.188	0.196	0.228	0.234	0.267	0.320
	3	–	–	0.127	0.135	0.168	0.173	0.179	0.209	0.214	0.244	0.293
	4	–	–	–	–	–	0.133	0.138	0.161	0.164	0.187	0.225
	5	–	–	–	–	–	–	0.116	0.135	0.138	0.158	0.189
	6	–	–	–	–	–	–	–	–	0.122	0.139	0.167
	7	–	–	–	–	–	–	–	–	–	0.125	0.151
Altura de rosca		0.289	0.404	0.433	0.544	0.577	0.722	0.866	1.010	1.155	1.443	1.732

Número de pasadas recomendado y profundidad de corte radial por pasada en roscas hembra unificadas (60°).

		Profundidad de corte radial por pasada (mm)									
		28	24	20	18	16	14	13	12	11	10
N.º de pasadas	1	0.203	0.237	0.232	0.258	0.251	0.287	0.309	0.299	0.327	0.328
	2	0.167	0.195	0.191	0.213	0.207	0.237	0.255	0.247	0.270	0.271
	3	0.154	0.179	0.175	0.195	0.190	0.217	0.234	0.226	0.247	0.248
	4	–	–	0.135	0.149	0.146	0.166	0.179	0.174	0.189	0.190
	5	–	–	–	–	0.123	0.140	0.151	0.146	0.160	0.160
	6	–	–	–	–	–	–	–	0.130	0.140	0.141
	7	–	–	–	–	–	–	–	–	–	0.128
Altura de rosca		0.524	0.611	0.733	0.815	0.917	1.047	1.128	1.222	1.333	1.466

**FRESAS DE ROSCAR – TABLA DE NÚMERO DE PASADAS**

Número de pasadas recomendado y profundidad de corte radial por pasada en roscas G (BSP) hembra (55°).

 1" / 1.23	Profundidad de corte radial por pasada (mm)				
	28	19	14	11	
N.º de pasadas	1	0.225	0.271	0.318	0.362
	2	0.186	0.224	0.263	0.299
	3	0.170	0.205	0.241	0.274
	4	–	0.156	0.185	0.210
	5	–	–	0.155	0.177
	6	–	–	–	0.157
	7	–	–	–	–
Altura de rosca	0.581	0.856	1.162	1.479	

Número de pasadas recomendado y profundidad de corte radial por pasada en roscas NPT hembra (60°).

 1" / 1.23	Profundidad de corte radial por pasada (mm)				
	27	18	14	11.5	
N.º de pasadas	1	0.283	0.348	0.390	0.423
	2	0.233	0.287	0.322	0.349
	3	0.214	0.263	0.295	0.320
	4	–	0.202	0.226	0.246
	5	–	–	0.190	0.207
	6	–	–	–	0.183
	7	–	–	–	–
Altura de rosca	0.730	1.100	1.423	1.728	

LIMAS ROTATIVAS – CONSEJOS GENERALES

Indicaciones generales sobre las limas de metal duro

La limas de metal duro a menudo se utilizan para la preparación y el acabado de componentes de una amplia variedad de materiales. Normalmente se utilizan de forma manual y se montan en amoladoras rectas con accionamiento neumático

Características y ventajas

1. Los mangos de acero templado mejoran la rigidez y reducen el riesgo de torsión o vibración.
2. Los mangos de precisión mejoran el agarre y reducen la probabilidad de rotación.
3. Los elementos especiales de soldadura previenen los fallos por alta temperatura y proporcionan mayor robustez para resistir la presión y los impactos.
4. La geometría universal de doble corte es adecuada para una amplia variedad de materiales y aplicaciones.
5. Existen también geometrías específicas adecuadas a cada material: acero (ST), acero inoxidable (VA), aluminio (AL) y fibra de vidrio (GRP).
6. Disponible con revestimiento de TiAlN para aumentar la vida útil de la herramienta con materiales abrasivos.
7. Las limas de punta esférica se fabrican con geometría de dientes alternos (Skip).
8. Esto proporciona una geometría activa hacia el centro de la lima, lo cual mejora el corte y reduce la probabilidad de acumulación y atascos de virutas.

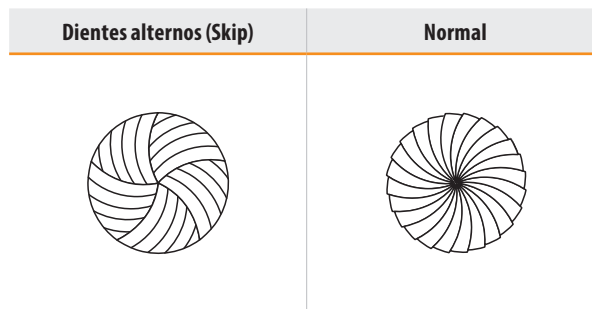

La seguridad es lo primero

1. Las herramientas de rotación de alta velocidad pueden ser peligrosas si no se emplean correctamente.
2. Desconecte siempre la amoladora recta del suministro de aire antes de cambiar la lima.
3. Compruebe el estado de la amoladora recta y utilice versiones de bajas vibraciones si es posible.
4. Utilice siempre el equipo de protección adecuado y asegúrese de que todas las personas que se encuentren cerca también estén protegidas.



El equipo de protección personal debe llevarse puesto en todo momento!

LIMAS ROTATIVAS – CONSEJOS GENERALES

Recomendaciones

- Utilice siempre la amoladora recta con la velocidad nominal adecuada.
- El mantenimiento rutinario de las amoladoras rectas es importante; asegúrese de que están engrasadas y de que los rodamientos no están desgastados.
- Cuando cambie la lima, limpie siempre la tuerca de fijación, la pinza y el macho de roscar interno de la amoladora recta.
- Intente evitar choques mecánicos y fuertes impactos en las limas.
- Para evitar el choque térmico, intente que la lima no se sobrecaliente.
- No introduzca la lima a mucha profundidad en el material de la pieza de trabajo ni la fuerce en esquinas o canales.

Trouble shooting using burrs

Problema	Causa
Desprendimiento de virutas de los dientes de la lima	Utilizar un régimen de revoluciones demasiado bajo puede causar rebotes
	Excentricidad (husillo, pinza o rodamiento desgastados)
	Introducción profunda y forzado de la lima en la pieza de trabajo
Obstrucción de los dientes de la lima	La longitud del canal o la longitud total es excesiva
	La geometría seleccionada no es adecuada para el material de la pieza de trabajo
Desgaste prematuro	Régimen de revoluciones demasiado elevado para el tamaño de la lima y el material de la pieza de trabajo
	Excentricidad (husillo, pinza o rodamiento desgastados)
Desprendimiento de la cabeza del mango	Régimen de revoluciones demasiado elevado, causa sobrecalentamiento
	Funcionamiento prolongado, causa sobrecalentamiento

LIMAS ROTATIVAS – VELOCIDAD DE TRABAJO RECOMENDADA

		AL							DC
ISO		(rev/min)							
		DC (mm)							
		3	6	8	10	12	16	20	
P	min.	64 000	32 000	24 000	20 000	16 000	12 000	10 000	
	max.	83 000	42 000	32 000	25 000	21 000	16 000	13 000	
M	min.	45 000	23 000	17 000	14 000	12 000	9 000	7 000	
	max.	64 000	32 000	24 000	20 000	16 000	12 000	10 000	
K	min.	58 000	29 000	22 000	19 000	15 000	11 000	9 000	
	max.	77 000	39 000	29 000	23 000	20 000	15 000	12 000	
N	min.	64 000	32 000	24 000	20 000	16 000	12 000	10 000	
	max.	96 000	48 000	36 000	29 000	24 000	18 000	15 000	
S	min.	45 000	23 000	17 000	14 000	12 000	9 000	7 000	
	max.	58 000	29 000	22 000	18 000	15 000	11 000	9 000	
H	min.	51 000	26 000	20 000	16 000	13 000	10 000	8 000	
	max.	71 000	36 000	27 000	22 000	18 000	14 000	11 000	

		ST					BR	
ISO		(rev/min)						
		DC (mm)						
		3	6	8	10	12		
P	min.	100 000	65 000	60 000	55 000	35 000		
	max.	60 000	45 000	35 000	30 000	20 000		

		VA					BR	
ISO		(rev/min)						
		DC (mm)						
		3	6	8	10	12		
M	min.	100 000	65 000	60 000	55 000	35 000		
	max.	60 000	30 000	25 000	20 000	15 000		

		GRP		
ISO		(rev/min)		
		DC (mm)		
		3	6	8
N4	min.	25 000	20 000	18 000
	max.	30 000	25 000	22 000

		AS	
ISO		(rev/min)	
		DC (mm)	
		3	
S	min.	60 000	
	max.	80 000	

WMG (GRUPO DE MATERIAL)

GRUPO ISO	WMG (GRUPO DE MATERIAL)		Dureza (HB o HRC)	Resistencia Traccion (MPa)		
P	P1	P1.1	Sulfurizados	< 240 HB	≤ 830	
		P1.2	Acero facil mecanizado	Sulfurizados y fosforizados	< 180 HB	≤ 620
		P1.3	(aceros al carbono con mayor maquinabilidad)	Sulfurizados/fosforizados y al plomo	< 180 HB	≤ 620
	P2	P2.1	ACEROS AL CARBONO (aceros compuestos principalmente de hierro y carbono)	Contiene < 0.25 % C	< 180 HB	≤ 620
		P2.2		Contiene < 0.55 % C	< 240 HB	≤ 830
		P2.3		Contiene > 0.55 % C	< 300 HB	≤ 1030
	P3	P3.1	ACEROS ALEADOS (aceros al carbono con un contenido de aleación del 10 %)	Recocido	< 180 HB	≤ 620
		P3.2		Templado y endurecido	180 – 260 HB	> 620 ≤ 900
		P3.3			260 – 360 HB	> 900 ≤ 1240
	P4	P4.1	ACERO DE HERRAMIENTAS (aleaciones especiales para herramientas, moldes y matrices)	Recocido	< 26 HRC	≤ 900
P4.2		Templado y endurecido		26 – 39 HRC	> 900 ≤ 1240	
P4.3				39 – 45 HRC	> 1240 ≤ 1450	
M	M1	M1.1	ACERO INOXIDABLE FERRITICO (aleaciones al cromo no endurecidas)	< 160 HB	≤ 520	
		M1.2		160 – 220 HB	> 520 ≤ 700	
	M2	M2.1	ACERO INOXIDABLE MARTENSITICO (aleaciones al cromo endurecidas)	Recocido	< 200 HB	≤ 670
		M2.2		Enfriadas y templadas	200 – 280 HB	> 670 ≤ 950
		M2.3		Templado por precipitacion	280 – 380 HB	> 950 ≤ 1300
	M3	M3.1	ACERO INOXIDABLE AUSTENITICO (aleaciones cromo - níquel y cromo - níquel - manganeso)	< 200 HB	≤ 750	
		M3.2		200 – 260 HB	> 750 ≤ 870	
		M3.3		260 – 300 HB	> 870 ≤ 1040	
	M4	M4.1	AUTENITICO-FERRITICO (DUPLEX) O ACERO INOXIDABLE SUPER AUSTENITICO	< 300 HB	≤ 990	
		M4.2	ACEROS INOXIDABLE AUSTENITICOS ENDURECIDOS POR PRECIPITACION	300 – 380 HB	≤ 1320	
K	K1	K1.1	FUNDICION GRIS (ASTM A48) O FUNDICION GRIS AUTOMOCION (ASTM A159) (fundicion hierro - carbono con micro estructura de grafito laminar)	Ferrítica o ferrítica-perlítica	< 180 HB	≤ 190
		K1.2		Ferrítica-perlítica o perlítica	180 – 240 HB	> 190 ≤ 310
		K1.3		Perlítica	240 – 280 HB	> 310 ≤ 390
	K2	K2.1	FUNDICION MALEABLE (ASTM A602) (fundición de hierro-carbono con una microestructura libre de grafito)	Ferrítica	< 160 HB	≤ 400
		K2.2		Ferrítica o perlítica	160 – 200 HB	> 400 ≤ 550
		K2.3		Perlítica	200 – 240 HB	> 550 ≤ 660
	K3	K3.1	FUNDICION DÚCTIL (ASTM A536) (fundición de hierro-carbono con microestructura de grafito nodular)	Ferrítica	< 180 HB	≤ 560
		K3.2		Ferrítica o perlítica	180 – 220 HB	> 560 ≤ 680
		K3.3		Perlítica	220 – 260 HB	> 680 ≤ 800
	K4	K4.1	FUNDICION GRIS AUSTENITICO (ASTM A436) (fundiciones de aleación de hierro-carbono con microestructura de grafito laminar austenítico)	< 180 HB	≤ 190	
K4.2		FUNDICION DÚCTIL AUSTENITICA (ASTM A439 o ASTM A571) (fundiciones de hierro-carbono con microestructura de grafito nodular austenítico)	< 240 HB	≤ 740		
K4.3		FUNDICION DÚCTIL AUSTEMPERADA (ASTM A897) (fundiciones de hierro y carbono con microestructura de ausferrita)	< 280 HB	> 840 ≤ 980		
K4.4			280 – 320 HB	> 980 ≤ 1130		
K4.5			320 – 360 HB	> 1130 ≤ 1280		
K5	K5.1	FUNDICION DE GRAFITO COMPACTADO CGI (ASTM A842) (fundición de hierro-carbono con estructura vermicular de grafito)	Ferrítico	< 180 HB	≤ 400	
	K5.2		Ferrítico-perlítico	180 – 220 HB	> 400 ≤ 450	
	K5.3		Perlítico	220 – 260 HB	> 450 ≤ 500	
N	N1	N1.1	Aluminio forjado comercialmente puro	< 60 HB	≤ 240	
		N1.2		Templado medio	60 – 100 HB	> 240 ≤ 400
		N1.3		Templado completo	100 – 150 HB	> 400 ≤ 590
	N2	N2.1	Fundicion de aluminio	< 75 HB	≤ 240	
		N2.2		75 – 90 HB	> 240 ≤ 270	
		N2.3		90 – 140 HB	> 270 ≤ 440	
	N3	N3.1	Aleaciones de cobre de facil mecanizacion	–	–	
		N3.2	Aleaciones de cobre de viruta corta con maquinabilidad moderada	–	–	
		N3.3	Cobre electrolítico y aleaciones de cobre de viruta larga con baja maquinabilidad	–	–	
	N4	N4.1	Polimeros termoplasticos	–	–	
N4.2		Polimeros termoendurecibles	–	–		
N4.3		Composites o polimeros reforzados	–	–		
N5	N5.1	Grafito	–	–		
S	S1	S1.1	Titanio o aleaciones de titanio	< 200 HB	≤ 660	
		S1.2		200 – 280 HB	> 660 ≤ 950	
		S1.3		280 – 360 HB	> 950 ≤ 1200	
	S2	S2.1	Aleaciones termostresistentes con base hierro	< 200 HB	≤ 690	
		S2.2		200 – 280 HB	> 690 ≤ 970	
	S3	S3.1	Aleaciones termostresistentes con base níquel	< 280 HB	≤ 940	
		S3.2		280 – 360 HB	> 940 ≤ 1200	
	S4	S4.1	Aleaciones termostresistentes con base cobalto	< 240 HB	≤ 800	
S4.2		240 – 320 HB		> 800 ≤ 1070		
H	H1	H1.1	Fundicion en frio	< 440 HB	–	
	H2	H2.1	Fundiciones templadas	< 55 HRC	–	
		H2.2		> 55 HRC	–	
	H3	H3.1	Aceros templados < 55 HRC	< 51 HRC	–	
		H3.2		51 – 55 HRC	–	
	H4	H4.1	Acero templados > 55 HRC	55 – 59 HRC	–	
		H4.2		> 59 HRC	–	



TABLA DE CONVERSIÓN DE DUREZA

Resistencia (MPa)	Dureza			
	BRINELL	VICKERS	ROCKWELL	ROCKWELL
R_m	HB	HV	HRB	HRC
285	86	90	1190	–
320	95	100	56.2	–
350	105	110	62.3	–
385	114	120	66.7	–
415	124	130	71.2	–
450	133	140	75.0	–
480	143	150	78.7	–
510	152	160	81.7	–
545	162	170	85.8	–
575	171	180	87.1	–
610	181	190	89.5	–
640	190	200	91.5	–
675	199	210	93.5	–
705	209	220	95	–
740	219	230	96.7	–
770	228	240	98.1	–
800	238	250	99.5	–
820	242	255	–	23.1
850	252	265	–	24.8
880	261	275	–	26.4
900	266	280	–	27.1
930	276	290	–	28.5
950	280	295	–	29.2
995	295	310	–	31.0
1030	304	320	–	32.2
1060	314	330	–	33.3
1095	323	340	–	34.4
1125	333	350	–	35.5
1155	342	360	–	36.6

Resistencia (MPa)	Dureza			
	BRINELL	VICKERS	ROCKWELL	ROCKWELL
R_m	HB	HV	HRB	HRC
1190	352	370	–	37.7
1220	361	380	–	38.8
1255	371	390	–	39.8
1290	380	400	–	40.8
1320	390	410	–	41.8
1350	399	420	–	42.7
1385	409	430	–	43.6
1420	418	440	–	44.5
1455	428	450	–	45.3
1485	437	460	–	46.1
1520	447	470	–	46.9
1555	456	480	–	47.7
1595	466	490	–	48.4
1630	475	500	–	49.1
1665	485	510	–	49.8
1700	494	520	–	50.5
1740	504	530	–	51.1
1775	513	540	–	51.7
1810	523	550	–	52.3
1845	532	560	–	53.0
1880	542	570	–	53.6
1920	551	580	–	54.1
1955	561	590	–	54.7
1995	570	600	–	55.2
2030	580	610	–	55.7
2070	589	620	–	56.3
2105	599	630	–	56.8
2145	608	640	–	57.3
2180	618	650	–	57.8

SIMPLY RELIABLE

Como profesional se puede juzgar la calidad del trabajo sólo mirando la viruta. Nuestra viruta es una forma limpia y sin complicaciones que en sí misma cuenta una historia. Es una señal clara y consistente y es por eso que la usamos como un símbolo por ser **Simplemente Fiables**.

DORMER PRAMET

www.dormerpramet.com



**CONTACTO DEL SOPORTE
DE VENTAS LOCAL
¡SIEMPRE ACTUALIZADO!**



DP-CAT-SOLIDMILL-2024-ES

FOLLOW US...



ONLINE



SEGMENTS



LIBRARY APP.



CALCULATOR APP.

